

Series overview

Series: Wilo-Stratos

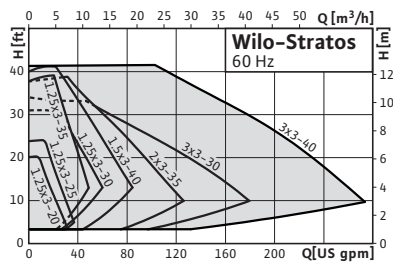

> Design

In line, flanged wet rotor circulator with EC motor and automatic capacity adjustment

> Application

Hot-water heating systems, air conditioning, closed cooling circuits, industrial circulation systems

> Special features/product benefits

- Energy efficiency class A
- Up to 80% power saving compared with constant speed circulating pumps
- Maximum efficiency thanks to ECM technology

> Description/design

- Wet rotor circulator with EC motor and integrated automatic capacity adjustment
- Red button technology for very easy operation
- Graphic pump display with rotatable display adjustable from US units(default) to metric
- Pump communication with IF (interface) module that can be easily retrofitted: ideal external operation
- Motor protection with electronic overload protection (min/max voltage, max temp, dry run, overload)
- Interface connection for extending built in functions, for building automation (BA) systems and external control
- Impeller with three-dimensional curved blades and rotor can using carbon fibre compound material

Heating, air-conditioning, cooling

High-efficiency pumps (single pumps)

Equipment/function	Wilo-Stratos							
	1.25x3-20	1.25x3-25	1.25x3-30	1.25x3-35	1.5x3-40	2x3-35	3x3-30	3x3-40
Operating modes								
Manual control mode (n=constant)					•			
Δp -c for constant differential pressure					•			
Δp -v for variable differential pressure					•			
Δp -T for temperature-controlled differential pressure					•			
Manual functions								
Operating mode setting					•			
Differential-pressure setpoint setting					•			
"Autopilot" setting (automatic setback operation)					•			
Pump ON/OFF setting					•			
Speed setting (manual control mode)					•			
Automatic functions								
Stageless power adjustment depending on the operating mode					•			
"Autopilot" automatic setback operation					•			
Deblocking function					•			
Soft start					•			
Full motor protection with integrated trip electronics					•			
External control functions								
"Analogue In 0 ... 10 V" control input (remote speed adjustment)					•			Possible with Stratos IF-Modules (accessories)
"Analogue In 0 ... 10 V" control input (remote adjustment setpoint)					•			Possible with Stratos IF-Modules (accessories)
Signal and display functions								
Collective fault signal (potential-free NC contact)					•			
Fault signal light					•			
LCD screen for indication of pump data and fault codes					•			
Data exchange								
Infrared interface for wireless data exchange with IR-Module/IR-Monitor (see IR-Module/IR-Monitor function table)					•			
Serial digital LON interface for connection to a LON-WORKS network					•			Possible with Stratos IF-Modules (accessories)

Equipment/function								
	Wilo-Stratos							
	1.25x3-20	1.25x3-25	1.25x3-30	1.25x3-35	1.5x3-40	2x3-35	3x3-30	3x3-40
Dual pump management (double pump or 2 x single pump)								
Main/standby mode (automatic fault-actuated switchover/time-dependent pump cycling)					•			
Parallel operation (efficiency-optimised peak load cut-in and out)	-	•		-			•	
Equipment/scope of delivery								
Including seals for threaded connection (loose)					•			
Including installation and operating instructions					•			

• = available, - = not available

Heating, air-conditioning, cooling

High-efficiency pumps (single pumps)

Technical Data								
	Wilo-Stratos...							
	1.25x3-20	1.25x3-25	1.25x3-30	1.25x3-35	1.5x3-40	2x3-35	3x3-30	3x3-40
Approved fluids (other fluids on request)								
Heating water	•	•	•	•	•	•	•	•
Water-glycol mixtures (max. 1:1; above 20% admixture, the pumping data must be checked)	•	•	•	•	•	•	•	•
Potable water and water for food-processing companies in accordance with TrinkwV 2001 (drinking water ordinance)	-	-	-	-	-	-	-	-
Output								
Max. delivery head [ft]	20	23	36	30	39	36	33	43
Max. delivery head [m]	6	7	11	9	12	11	10	13
Max. volume flow [USGPM]	30.8	35.2	48.4	57.2	83.7	127.7	180.5	273.0
Max. volume flow [m ³ /h]	7	8	11	13	19	29	41	62
Permitted field of application								
Temperature range	14 °F (- 10 °C) up to 230 °F (+ 110 °C)							
Max. ambient temperature	104 °F (+40 °C)							
Max. working pressure, p _{max} [psi]	145							
Pipe connections								
Nominal flange diameter	1.25	1.25	1.25	1.25	1.5	2.0	3.0	3.0
non ANSI flange (oval, rotated 90°)	•	•	•	•	-	-	-	-
non ANSI flange (oval)	-	-	-	-	•	-	-	-
non ANSI flange (round)	-	-	-	-	-	•	-	-
ANSI flange	-	-	-	-	-	-	•	•
Electrical connection								
Mains connection 1 ~ [V], standard version	230	230	230	230	230	230	230	230
Mains connection 3 ~ [V], standard version	230	230	230	230	230	230	230	230
Mains frequency	60	60	60	60	60	60	60	60
Motor/electronics								
Power electronics	Frequency converter							
Degree of protection	Enclosure 2/CSA							
Insulation class	F	F	F	F	F	F	F	F

Technical Data

	Wilo-Stratos...							
	1.25x3-20	1.25x3-25	1.25x3-30	1.25x3-35	1.5x3-40	2x3-35	3x3-30	3x3-40
Materials								
Pump housing	Grey cast iron (EN-GJL-250)							
Impeller	Plastic (PPS - 40% GF)						Plastic (PP - 50% GF)	
Pump shaft	Stainless steel (X46Cr13)							
Bearing	Carbon, metal impregnated							
Minimum suction head at suction port [psi] for preventing cavitation at water pumping temperature								
Minimum suction head at 122 °F (50°C)	4.3	4.3	4.3	4.3	7.1	7.1	10.0	10.0
Minimum suction head at 203 °F (95°C)	14.2	14.2	14.2	14.2	17.1	17.1	21.3	21.3
Minimum suction head at 230 °F (110°C)	22.8	22.8	22.8	22.8	25.6	25.6	32.7	32.7

• = available, - = not available

Heating, air-conditioning, cooling

High-efficiency pumps (single pumps)

Pump curves

Wilco-Stratos 1.25x3-20

$\Delta p-c$ (constant)

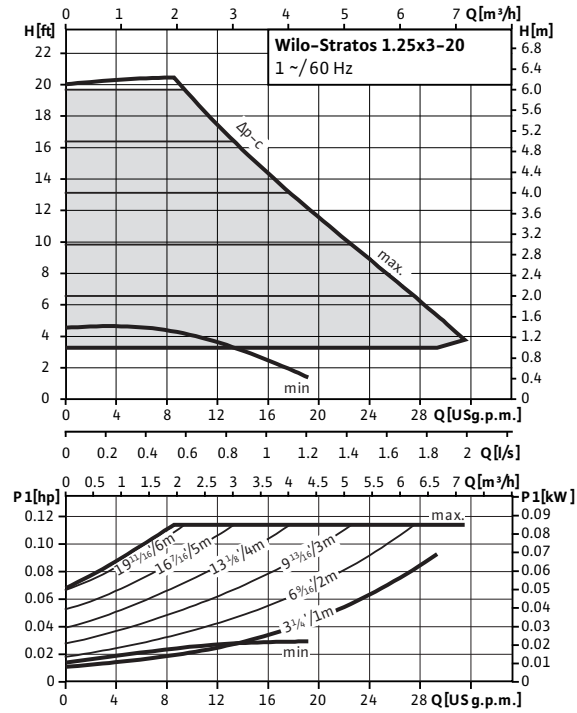

$\Delta p-v$ (variable)

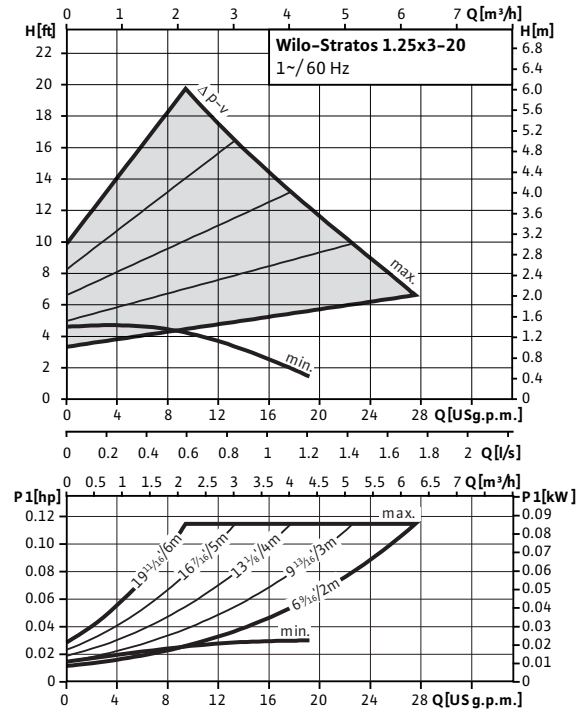

Wilco-Stratos 1.25x3-25

$\Delta p-c$ (constant)

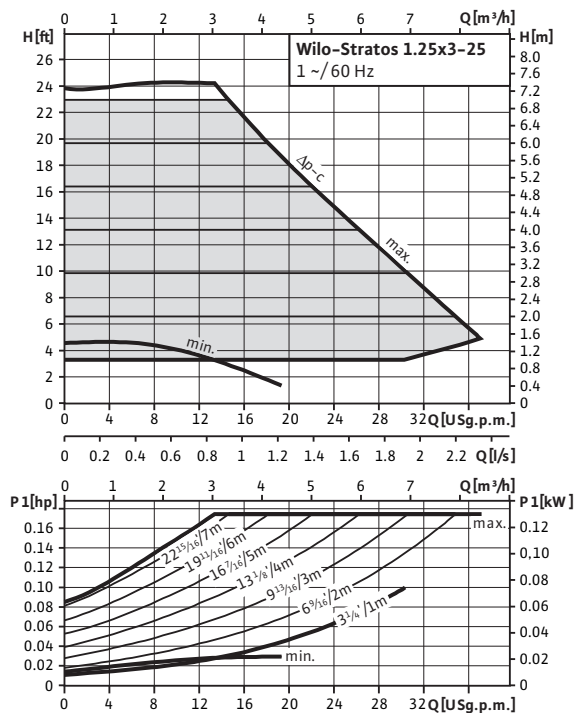

$\Delta p-v$ (variable)

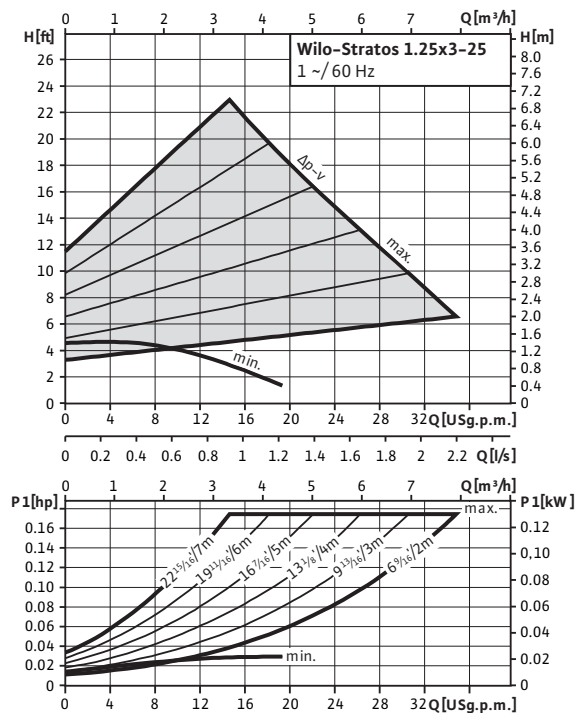

Pump curves

Wilco-Stratos 1.25x3-30

Δp -c (constant)

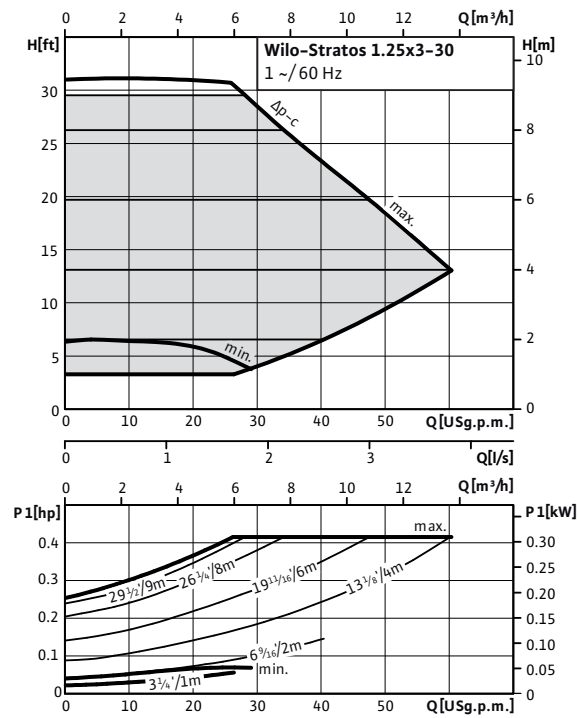

Δp -v (variable)

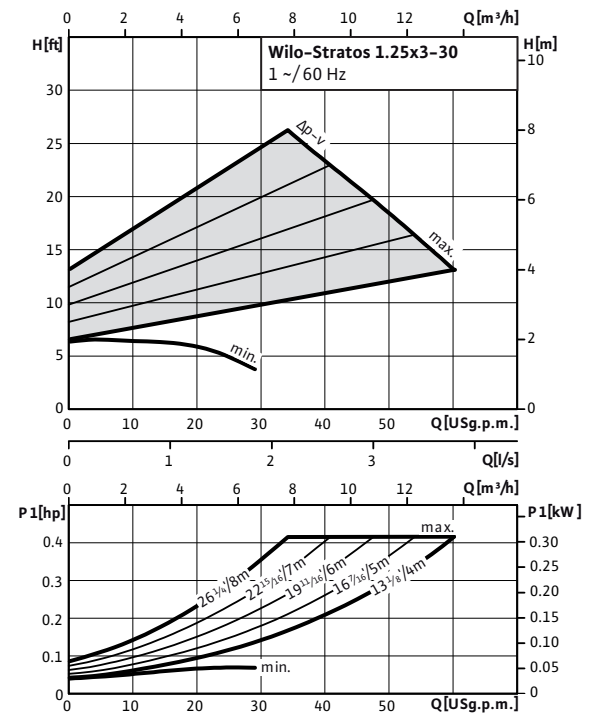

Wilco-Stratos 1.25x3-35

Δp -c (constant)

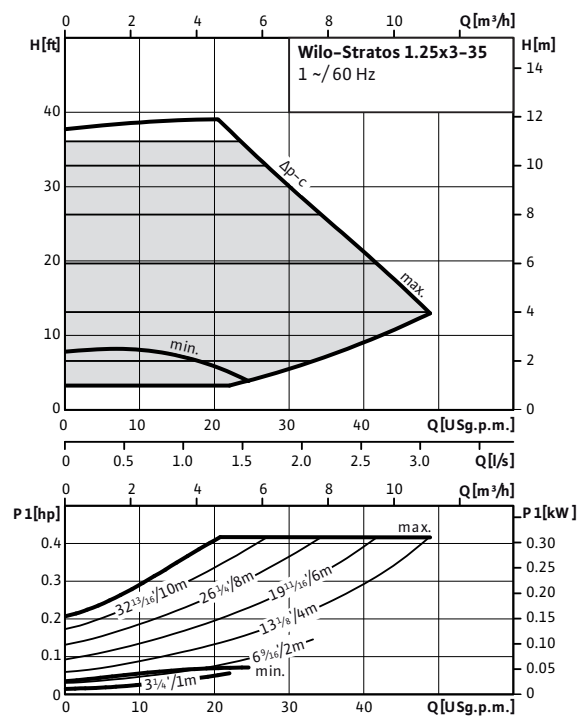

Δp -v (variable)

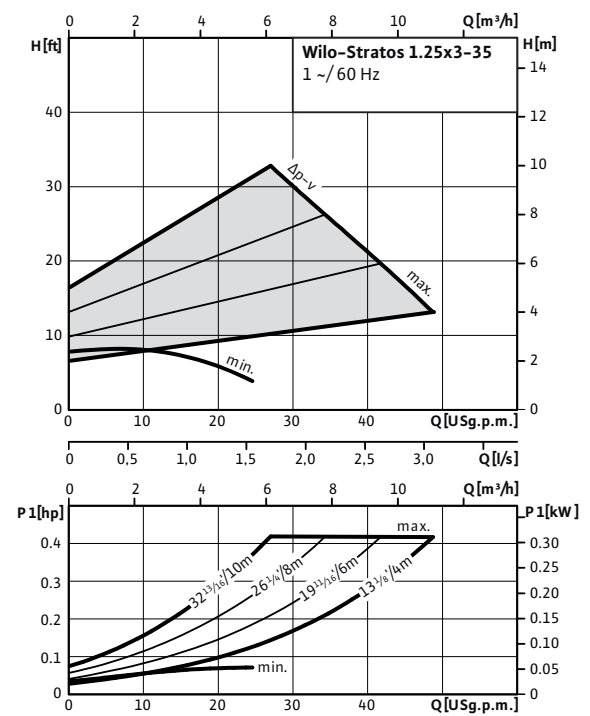

Heating, air-conditioning, cooling

High-efficiency pumps (single pumps)

Pump curves

Wilco-Stratos 1.5x3-40

$\Delta p-c$ (constant)

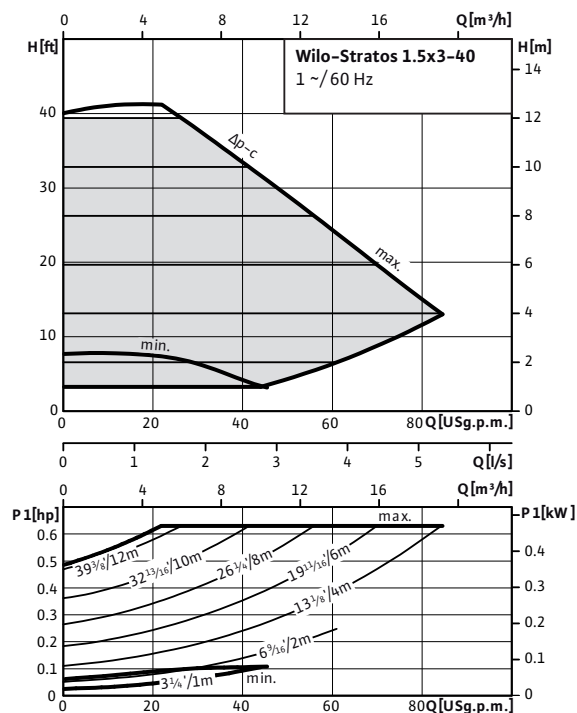

$\Delta p-v$ (variable)

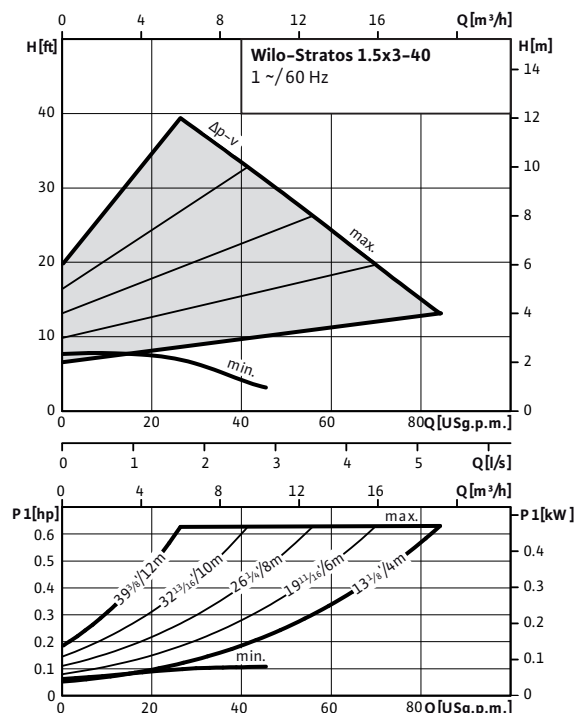

Wilco-Stratos 2x3-35

$\Delta p-c$ (constant)

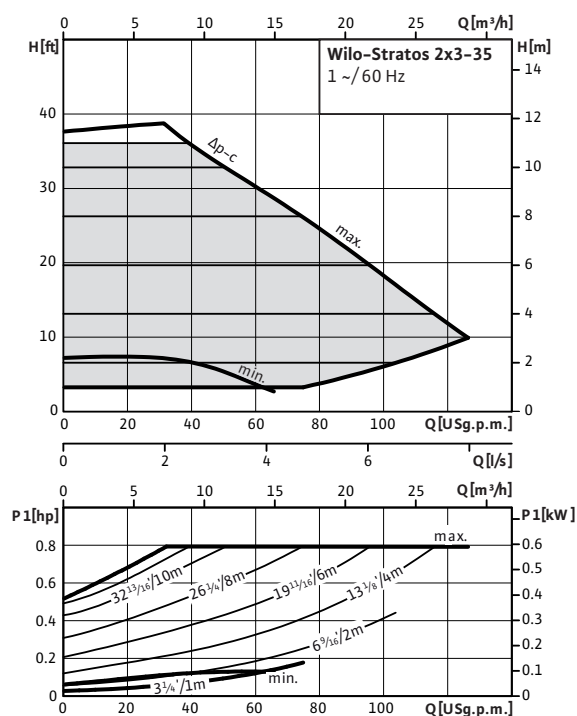

$\Delta p-v$ (variable)

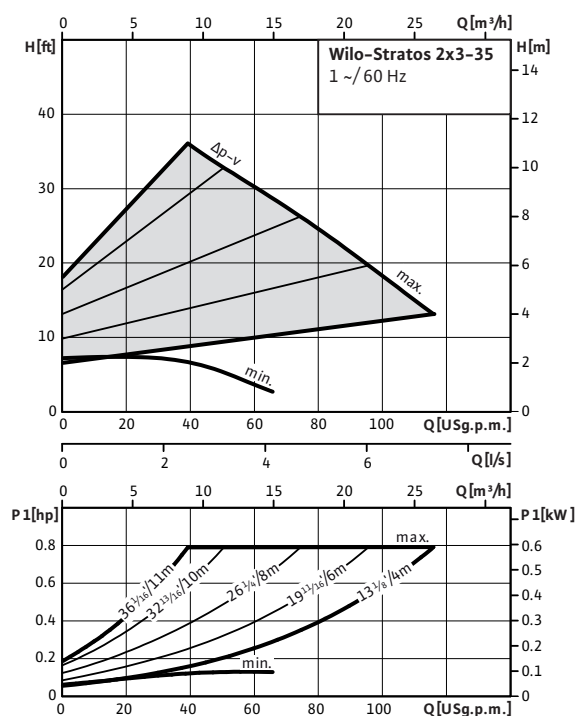

Pump curves

Wilco-Stratos 3x3-30

Δp -c (constant)

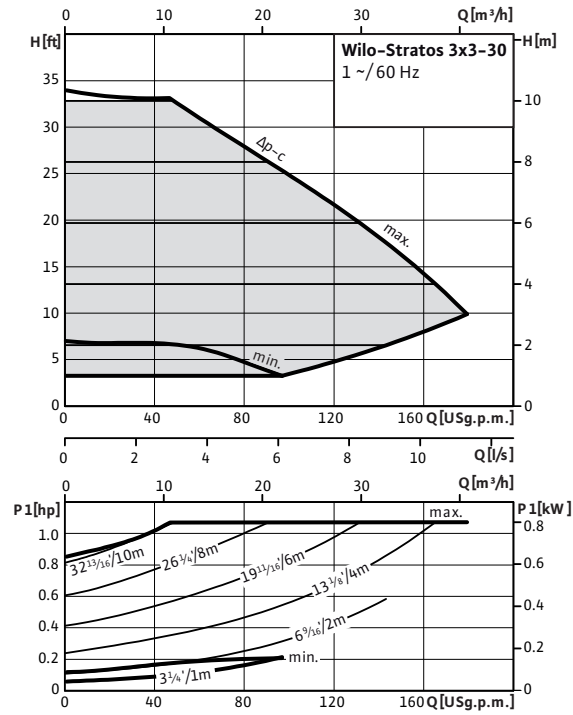

Δp -v (variable)

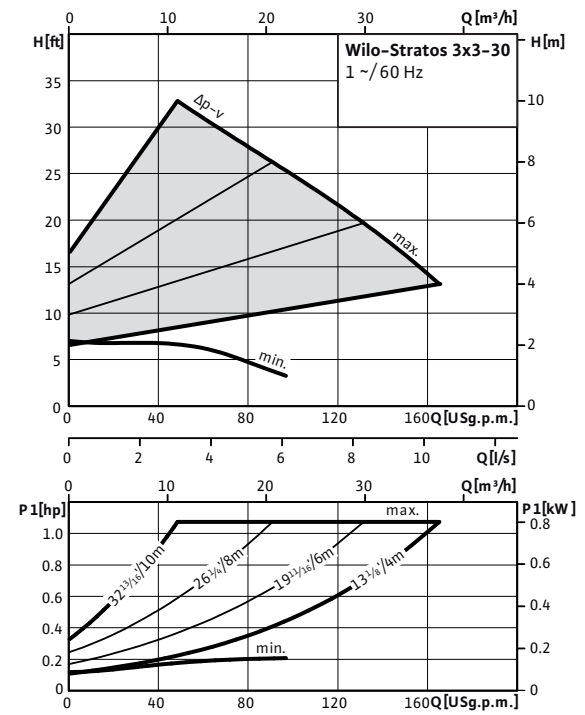

Wilco-Stratos 3x3-40

Δp -c (constant)

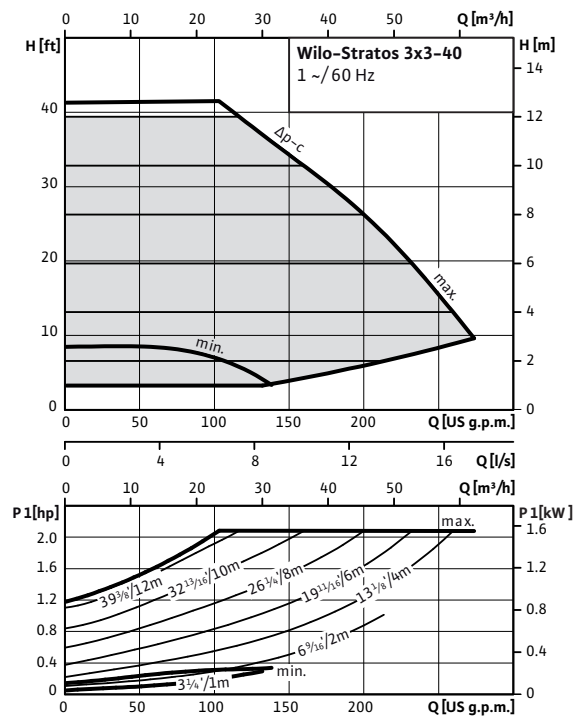

Δp -v (variable)

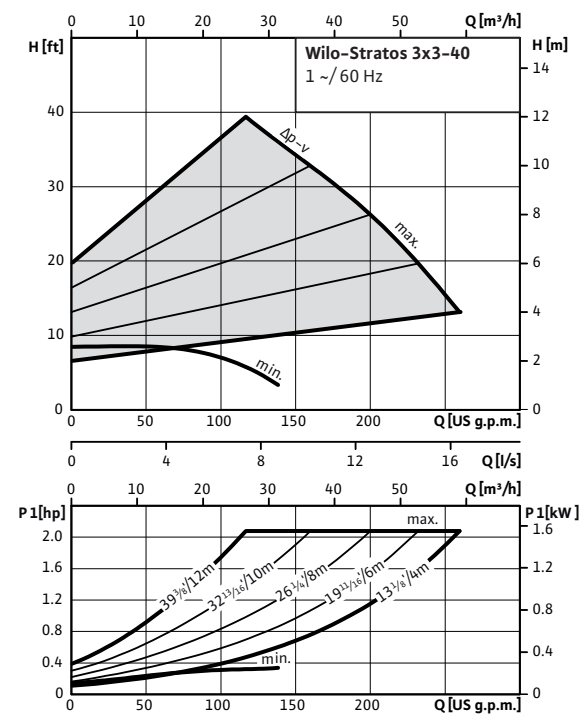

Heating, air-conditioning, cooling

High-efficiency pumps (single pumps)

Wiring diagram, motor data

Wiring diagram

FC: Collective fault signal (NC contact rating 1 A, 250 V~)

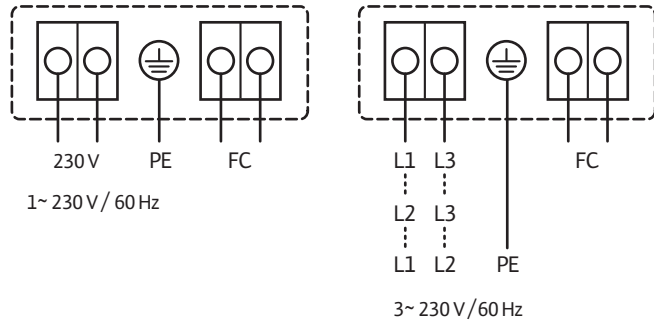

Motor data

Wilo-Stratos...	Nominal motor power		Speed	Power consumption 1~230 V	Power consumption 1~230 V	Current at 1~230V	Current at 3~230V	Motor protection	Threaded cable connection
	P ₂		n	P ₁	P ₁	I		-	PG
	[hp]	[W]	[rpm]	[hp]	[W]	[A]		-	-
1.25x3-20	0.087	65	1400 - 3400	0.01 - 0.11	9 - 85	0.13 - 0.78	0.13 - 0.78	integrated	1xNPT 1/4"/ 1xNPT 1/2"
1.25x3-25	0.134	100	1400 - 3700	0.01 - 0.17	9 - 130	0.13 - 1.20	0.13 - 1.20	integrated	1xNPT 1/4"/ 1xNPT 1/2"
1.25x3-30	0.268	200	1600 - 4800	0.02 - 0.42	16 - 310	0.16 - 1.37	0.16 - 1.37	integrated	1xNPT 1/4"/ 1xNPT 1/2"
1.25x3-35	0.268	200	1600 - 4800	0.02 - 0.42	16 - 310	0.16 - 1.37	0.16 - 1.37	integrated	1xNPT 1/4"/ 1xNPT 1/2"
1.5x3-40	0.469	350	1400 - 4600	0.03 - 0.63	25 - 470	0.20 - 2.05	0.20 - 2.05	integrated	1xNPT 1/4"/ 1xNPT 1/2"
2x3-35	0.671	500	1400 - 4600	0.03 - 0.79	25 - 590	0.20 - 2.60	0.20 - 2.60	integrated	1xNPT 1/4"/ 1xNPT 1/2"
3x3-30	0.872	650	950 - 3300	0.05 - 1.07	38 - 800	0.30 - 3.50	0.30 - 3.50	integrated	1xNPT 1/4"/ 1xNPT 1/2"
3x3-40	1.743	1300	900 - 3300	0.05 - 2.08	40 - 1550	0.32 - 6.80	0.32 - 6.80	integrated	1xNPT 1/4"/ 1xNPT 1/2"

Dimensions, weights

Dimension drawing 1

Dimension drawing 2

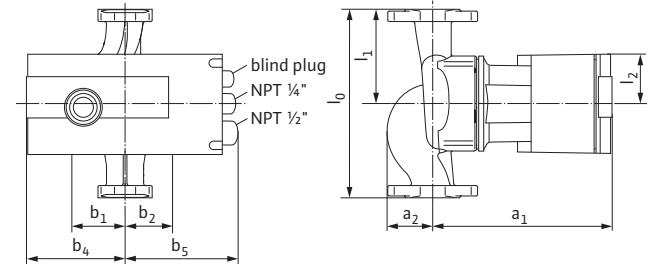
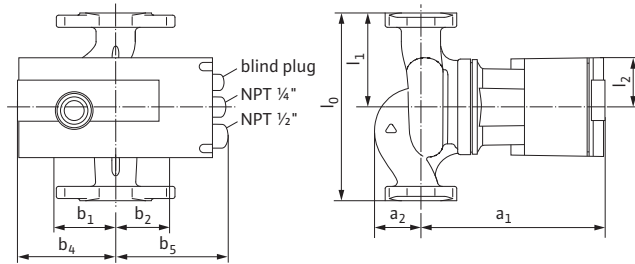

Dimension drawing 3

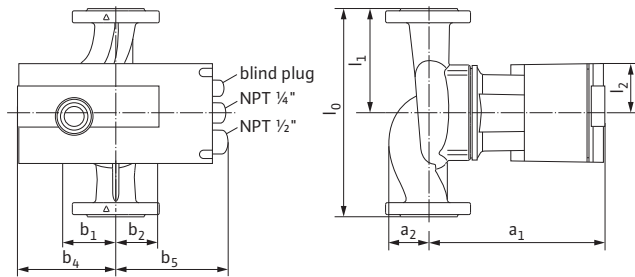

Dimension drawing flange 1

Dimension drawing flange 2

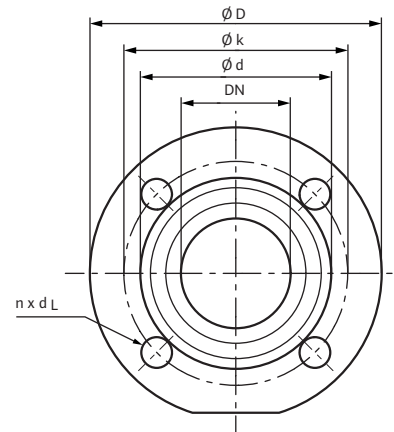
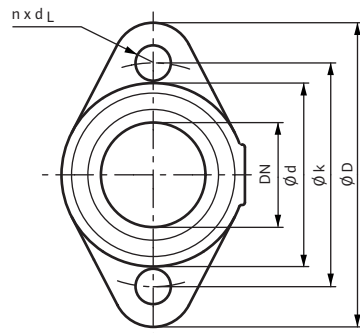

Heating, air-conditioning, cooling

High-efficiency pumps (single pumps)

Dimensions, weights

Dimensions, weights												
Wilo-Stratos...	Nominal flange diameter		Overall length		Dimensions							
	DN		l ₀		l ₁		l ₂		a ₁		a ₂	
	[In.]	[mm]	[In.]	[mm]	[In.]	[mm]	[In.]	[mm]	[In.]	[mm]	[In.]	[mm]
1.25x3-20	1.25	32	6 ¹ / ₂	165	3 ¹ / ₄	82.5	1 ¹⁵ / ₁₆	49	7 ³ / ₁₆	182	1 ¹¹ / ₁₆	43
1.25x3-25	1.25	32	6 ¹ / ₂	165	3 ¹ / ₄	82.5	1 ¹⁵ / ₁₆	49	7 ³ / ₁₆	182	1 ¹¹ / ₁₆	43
1.25x3-30	1.25	32	8 ¹ / ₂	216	4 ¹ / ₄	108	2 ³ / ₁₆	55	8 ¹ / ₁₆	204	1 ⁷ / ₈	48
1.25x3-35	1.25	32	8 ¹ / ₂	216	4 ¹ / ₄	108	2 ³ / ₁₆	55	7 ¹⁵ / ₁₆	201	1 ¹⁵ / ₁₆	50
1.5x3-40	1.5	40	10	254	5	127	2 ⁵ / ₈	66	9 ¹⁵ / ₁₆	252	2 ⁷ / ₁₆	62
2x3-35	2	50	11	279	5 ¹ / ₂	139.5	2 ⁵ / ₈	66	10 ¹ / ₁₆	256	2 ⁷ / ₁₆	62
3x3-30	3	80	14	356	7	178	3 ¹ / ₁₆	78	12 ¹³ / ₁₆	325	3 ⁷ / ₁₆	87
3x3-40	3	80	14	356	7	178	3 ¹ / ₁₆	78	12 ¹⁵ / ₁₆	329	3 ⁹ / ₁₆	90

Dimensions, weights												
Wilo-Stratos...	Dimensions									Weight approx.		Dimension drawing
	b ₁		b ₂		b ₄		b ₅		M		-	
	[In.]	[mm]	[In.]	[mm]	[In.]	[mm]	[In.]	[mm]	[lbs]	[kg]	-	
1.25x3-20	2 ¹ / ₈	54	1 ⁷ / ₈	48	3 ¹ / ₂	89	5 ⁹ / ₁₆	142	13.2	6.0	1	
1.25x3-25	2 ¹ / ₈	54	1 ⁷ / ₈	48	3 ¹ / ₂	89	5 ⁹ / ₁₆	142	14.3	6.5	1	
1.25x3-30	2 ¹ / ₂	63	2 ¹ / ₈	54	4 ³ / ₁₆	106	5 ¹¹ / ₁₆	145	17.6	8.0	1	
1.25x3-35	2 ³ / ₈	61	2 ³ / ₁₆	55	4 ³ / ₁₆	106	5 ¹¹ / ₁₆	145	17.6	8.0	1	
1.5x3-40	2 ⁷ / ₈	73	2 ¹ / ₂	64	4 ³ / ₄	120	6 ⁷ / ₁₆	163	26.5	12.0	2	
2x3-35	3 ¹ / ₄	82	2 ¹ / ₂	64	4 ³ / ₄	120	6 ⁷ / ₁₆	163	33.1	15.0	3	
3x3-30	4 ¹ / ₁₆	103	3 ⁵ / ₁₆	84	6 ¹ / ₈	156	7 ¹ / ₂	191	68.3	31.0	3	
3x3-40	4 ⁷ / ₁₆	113	3 ⁹ / ₁₆	90	6 ¹ / ₈	156	7 ¹ / ₂	191	72.8	33.0	3	

Flange dimensions												
Wilo-Stratos...	Flange	Nominal flange diameter		Pump flange dimensions							Dimension drawing, flange	
		DN		ø D		ø d		ø k		n x ø d _L		
	-	[In.]	-	[In.]	[mm]	[In.]	[mm]	[In.]	[mm]	[pcs. x mm]	-	
1.25x3-20	Non ANSI (oval 90° rotated)	1.25	32	4 ³ / ₄	121	2 ⁷ / ₈	73	3 ¹ / ₂	89	2 x 14	2 x 14	1
1.25x3-25	Non ANSI (oval 90° rotated)	1.25	32	4 ³ / ₄	121	2 ⁷ / ₈	73	3 ¹ / ₂	89	2 x 14	2 x 14	1
1.25x3-30	Non ANSI (oval 90° rotated)	1.25	32	4 ³ / ₄	121	2 ⁷ / ₈	73	3 ¹ / ₂	89	2 x 14	2 x 14	1
1.25x3-35	Non ANSI (oval 90° rotated)	1.25	32	4 ³ / ₄	121	2 ⁷ / ₈	73	3 ¹ / ₂	89	2 x 14	2 x 14	1
1.5x3-40	Non ANSI (oval)	1.5	40	4 ³ / ₄	121	2 ⁷ / ₈	73	3 ¹ / ₂	89	2 x 14	2 x 14	1
2x3-35	Non ANSI (round)	2	50	5 ¹ / ₄	133	3 ⁷ / ₁₆	87	4	102	4 x 14	4 x 14	2
3x3-30	ANSI R.F. Class 125 ASTMA 126	3	80	7 ⁹ / ₁₆	192	5 ¹ / ₁₆	128	6	152	4 x 19	4 x 19	2
3x3-40	ANSI R.F. Class 125 ASTMA 126	3	80	7 ⁹ / ₁₆	192	5 ¹ / ₁₆	128	6	152	4 x 19	4 x 19	2