

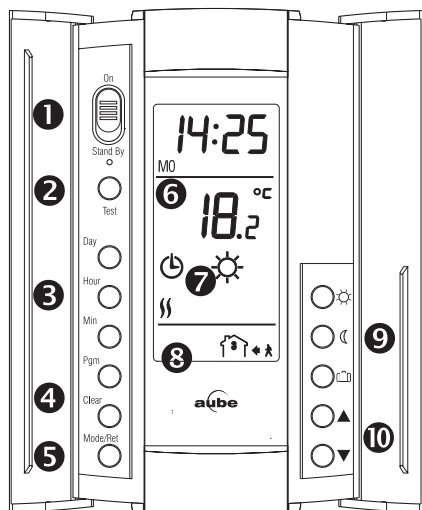

TH115 A/F/AF Owner's Guide

Thank you for choosing the Aube TH115, a programmable thermostat that provides both energy savings and comfort.



4 First Power ON

When power is applied for the first time, the LCD displays: 0:00, MO (Monday), and temperature (room/floor).

- Press HOUR - MIN to set the current time.
- Press DAY to set current day.

For AF and F models: one of the two following messages may be displayed if the installation is incorrect:

LO: The floor temperature is below 32°F (0°C), or the temperature sensor is defective, or not connected.

The heating indicator is displayed and the relay is closed (energized).

HI: The floor temperature is above 140°F (60°C), or the temperature sensor is defective.

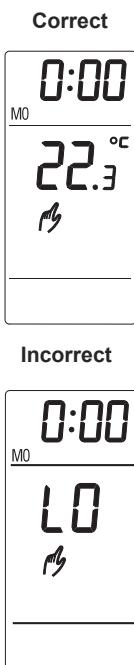

1 TH115 Description

Buttons and symbols

- On/Stand By Switch**
Use this switch to put the thermostat in sleep mode when its use is no longer required (e.g. summer). This will not affect the clock or programming.
- GFCI Warning Light and Test Button**
- Day & Clock Settings**
- Programming Mode**
- Mode Selection/Exit Programming**
- Room OR Floor Temperature**
- Current Mode and Setpoint**
- Current Program Number**
- Setpoint definition/Pre-defined Setpoints**
- Increase/Decrease Temperature**

Models

- A** Controls the Ambient temperature.
- AF** Controls the Ambient temperature and Floor temperature limit.
- F** Controls the Floor temperature.

2 Switch Selection

This thermostat is factory-set to the following values:

#	Function	UP	DN
SW1	Temperature format ^a	°F	°C
SW2	Early Start ^b	Disable	Enable
SW3	Time format	12-hour	24-hour

- If you switch from °F to °C or vice versa, the , and setpoints may need to be redefined.
- When using AUTO mode, the thermostat calculates the optimum start time to obtain the desired temperature by the set time. The heating system could be started a few hours prior to set time when required.

Switches are located on the rear of the control module. To modify any setting, switch UP or DN.

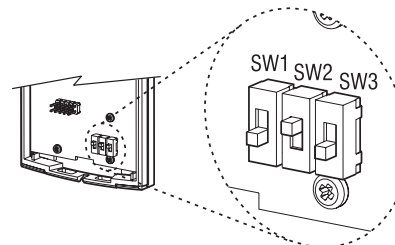

3 Control Module Installation

Align the bracket tabs on the control module with the holes located on top of the power base.

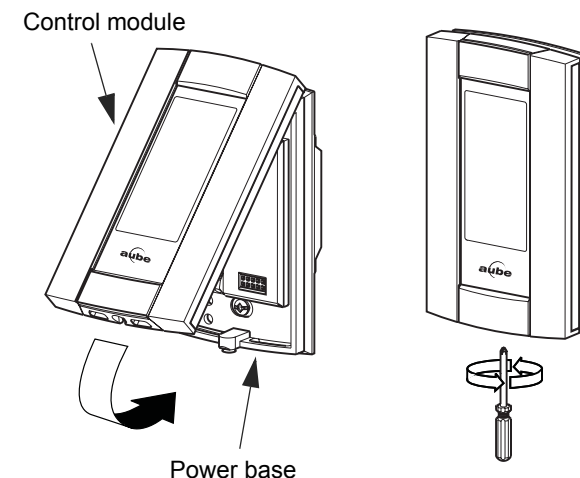

NOTE: Keep the thermostat's air vents clean and free from obstructions.

NOTE: The screw cannot be removed completely.

5 GFCI Test (GA & GB power base only)

The GFCI monitors the electrical flow for any loss of current; if there is one, the thermostat will cut off power to the heating system. We recommend you test the GFCI immediately after installing the control module, and once a month thereafter to ensure it is operating properly. To test:

- Increase the temperature until the heating indicator is displayed.

- Press TEST:

- Successful:** the TEST warning light is ON and power to heating system is cut off.
- Unsuccessful:** the TEST warning light is OFF. Cut power to heating system from the main power panel and call customer service.

- When successful, reset thermostat (Stand By/On) to power the heating system.

NOTE: If the test warning light comes ON during normal operation, cut power to heating system from the main power panel and have an electrician verify the installation.

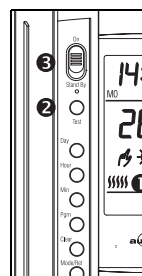

6 Temperature Setpoint

The following temperature setpoints are pre-programmed:

Symbol	Description	Default		New
		A/AF	F	
	Comfort (when at home)	70°F	82°F	
	Economy (when asleep/away from home)	64°F	68°F	
	Vacation (during prolonged absence)	50°F	50°F	

To modify a setpoint:

- Set the desired temperature using .
- Press and Hold the or or button until symbol is displayed.
- Press RET to exit.

Floor temperature limit—The floor temperature limit is 82°F. To modify this limit:

- Press and hold while switching from ON to Stand By then back to On.
- Set temperature .
- Press RET to exit.

To avoid damaging your floor, we recommend you follow the supplier's instructions.

7 Operating Modes

Automatic —Executes the schedule.

- Press MODE until is displayed. The current program number is displayed. You can temporary bypass the current program by setting a specific temperature or by pressing on a pre-defined setpoint button (,). The new setpoint will be maintained until the beginning of the next program.

Manual —Maintains a constant temperature.

- Press MODE until is displayed.
- Set temperature or press (,) to use pre-defined setpoint.

Vacation —Maintains the Vacation setpoint during a prolonged absence.

- Press until the icon is displayed.



8 Pre-programmed Schedule

The TH115 programmable thermostat is pre-programmed with the following schedule:

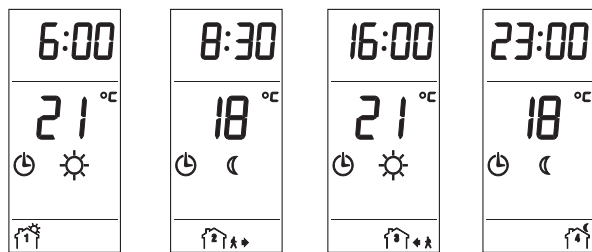

Time you wake up and desired temperature

Time you leave and temperature during your absence

Time you return home and desired temperature

Time you go to bed and overnight temperature

Programs	MO	TU	WE	TH	FR	SA	SU
	6:00	6:00	6:00	6:00	6:00	6:00	6:00
	8:30	8:30	8:30	8:30	8:30	--:--	--:--
	16:00	16:00	16:00	16:00	16:00	--:--	--:--
	23:00	23:00	23:00	23:00	23:00	23:00	23:00

Temperature Control

The TH115 thermostat works differently than conventional electromechanical thermostats.

It is equipped with a proportional integral adaptive (P.I.A.) controller which determines heating cycles by analyzing the temperature behavior history within the room.

The P.I.A. controller reduces temperature variations providing an accurate temperature control while increasing user comfort.

The controller determines the amount of power required by the heating system to maintain the setpoint temperature.

1	2	3	4	5
1 to 20%	21 to 40%	41 to 60%	61 to 80%	81 to 100%

9 Modify the Schedule

Notes:

- ▶ You can program up to 4 different programs per day. Each day can have different programs.
- ▶ It is sometimes faster to program the same schedule for the entire week and then to modify the exception days.

To modify:

- 1 Press PGM to access the programming mode
- 2 Press DAY to select the day to be programmed (hold for 3 seconds to select all days of the week).
- 3 Press PGM to select the program number.
- 4 Press HOUR and MIN to set the time or press CLEAR to clear the time (--:-- is disregarded).
- 5 Repeat steps 2 to 4 for remaining programs.
- 6 When completed, press RET to exit mode.

NOTE: After 60 seconds of inactivity, the thermostat will automatically exit programming mode.

Technical Specifications

Model: TH115 A / AF / F

Display range: 32°F to 140°F (0°C to 60°C)

Setting range (ambient): 40°F to 86°F (5°C to 30°C)

Setting range (floor limit): 40°F to 104°F (5°C to 40°C)

Pre-programmed temperature setpoints:

- ▶ **Comfort:** A/AF: 70°F (21°C) and F: 82°F (28°C)
- ▶ **Economy:** A/AF: 64°F (18°C) and F: 68°F (20°C)
- ▶ **Vacation:** A/F/AF: 50°F (10°C)
- ▶ **Floor limit:** AF: 82°F (28°C)

Accuracy: ± 0.9°F (0.5°C)

Storage: -4°F to 120°F (-20°C to 50°C)

Temperature control: Proportional integral adaptive, 15-minute or 15-second heating cycles according to the application and power base.

Memory backup: In the event of a power failure, an internal circuit will maintain the programming. Only the time will have to be set if the power failure is more than two (2) hours. The thermostat will return to the same operating mode as set before the power failure.

Custom Grid

Use this blank grid to record your new schedule.

Prog	Setpoint	MO	TU	WE	TH	FR	SA	SU

- ▶ Model: A F AF
- ▶ Temperature display: °F °C
- ▶ Time display: 12hrs 24hrs

Warranty

AUBE TECHNOLOGIES INC. ONE (1) YEAR LIMITED WARRANTY

This product is guaranteed against workmanship defects for a one year period following the initial date of purchase. During this period, AUBE Technologies Inc. will repair or replace, at our option and without charge, any defective product which has been used under normal conditions.

The warranty does not cover delivery costs and does not apply to products poorly installed or randomly damaged following installation.

This warranty cancels and replaces any other manufacturer's express or implied warranty as well as any other company commitment. AUBE Technologies Inc. cannot be held liable for related or random damages following the installation of this product.

The defective product as well as the purchase invoice must be returned to the place of purchase or mailed, prepaid and insured, to the following address:

Aube Technologies Inc.
705 Montrichard
Saint-Jean-sur-Richelieu, Quebec, Canada J2X 5K8

10 Remote Input

The TH115 is equipped with a remote input which allows connection of a telephone controller (accessory Aube CT240) or any other remote control system.

When a signal is received through this input, the TH115 will automatically switch from normal operating mode to Vacation mode () and vice versa when the signal is removed.

Activating the Vacation mode

There are two ways to activate the Vacation mode:

- 1 From the thermostat, see "Operating Modes" above.
- 2 From a telephone (remote location). For details on how to activate using a telephone, refer to the CT240 Instruction Manual.

WARNING: When the Vacation mode is activated remotely, it must be deactivated remotely.

If you have any questions concerning the installation or programming of the TH115 programmable thermostat, call our technical support team at:

Phone: Montreal area:(450) 358-4600
Canada / U.S.:1-800-831-AUBE (2823)
Fax: (450) 358-4650
Email: service@aubetech.com

Monday to Friday from 8:30 AM to 5:00 PM EST

For more information on our products, visit us at:
www.aubetech.com



As an ENERGY STAR® partner, Aube Technologies has determined that this product meets the ENERGY STAR guidelines for energy efficiency.

1 Applications

The PB112-024T power base can be used on any TH11x series thermostat (with the exception of the TH110 model). This low-voltage power base operates on 15-minute cycles and can be connected to a line-voltage load using a relay or directly to a 24-volt device. The PB112-024T is compatible with most relays; however, the following Aube relays are optimized for use with this power base:

- RT850 solid-state relay (SSR)
- RT850T solid-state relay (SSR) with built-in 24-V transformer
- RC840 electromechanical relay
- RC840T electromechanical relay with built-in 24-V transformer

2 Supplied Parts

- 1 One (1) power base
- 2 Two (2) plastic anchors
- 2 Two (2) mounting screws

3 Installation Guidelines

- ▶ For a new installation, choose a location about 1.5 m (5 ft.) above the floor.
- ▶ The thermostat must be installed on an inside wall facing the heating system (except for floor heating systems).
- ▶ Avoid locations where there are air drafts (top of staircase, air outlet), dead air spots (behind a door), direct sunlight or concealed chimney or stove pipes (except for floor heating systems).

4 Installation Procedure

The installation must be carried out by an electrician and comply with local electrical codes.

- 1 Turn off power to the heating system at the main electrical panel to avoid electrical shock.
- 2 Wire the base according to your application. See typical wiring diagrams in sections 4.1 to 4.4.
- 3 For a floor heating system installation, connect the floor sensor between the S and R terminals.
- 4 Secure the base to the wall using the provided screws and wall anchors.
- 5 Configure the switches located on the control module (if any). Refer to the user guide.
- 6 Install the control module onto the base.
- 7 Apply power to the heating system.
- 8 Verify the installation by checking that the heating system can be turned on or off using the thermostat.

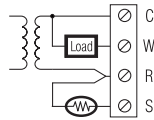

4.1 Single SSR with Built-in Transformer

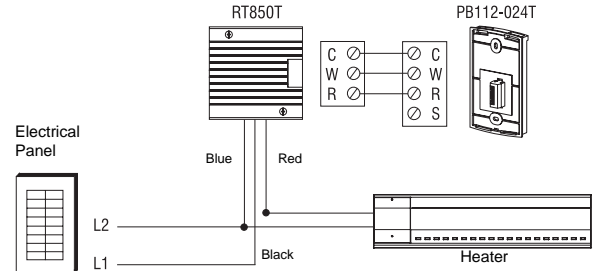

4.2 Multiple SSRs with External Transformer

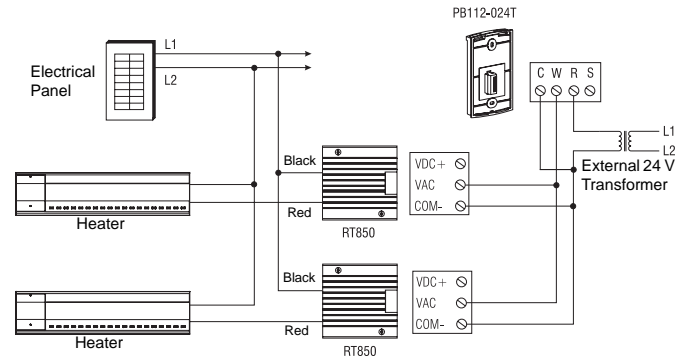

4.3 Electromechanical Relay with External Transformer

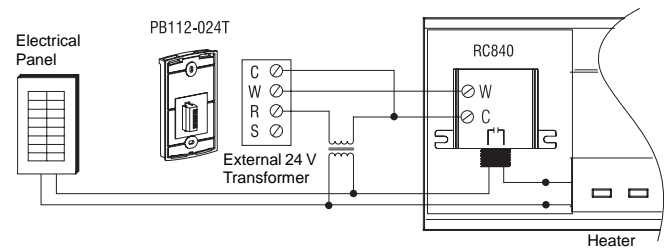

4.4 Hot Water Heater Valve

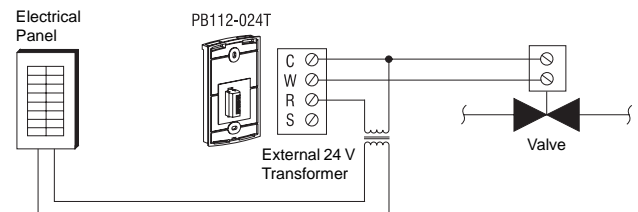

5 Technical Specifications

Maximum load: 0.5 A / 24 VAC

Heating cycle length: 15 minutes

Operating temperature: 32°F to 122°F (0°C to 50°C)

Storage: -4°F to 122°F (-20°C to 50°C)

Size (H • W • D): 124 x 70 x 23 mm (4.89 x 2.76 x 0.91 in)

Wire gauge: 14 to 22 AWG