

## Programmable Thermostat Owners Manual Model: PS3110 Series

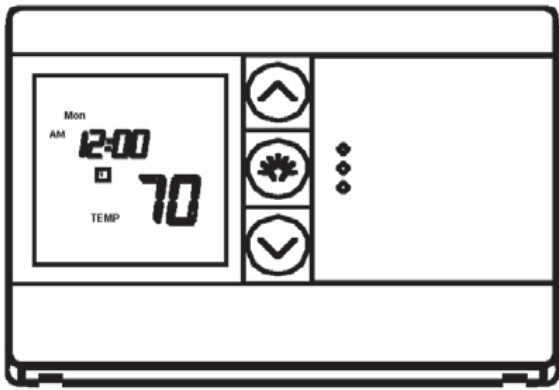

### Congratulations!

Your new thermostat will provide years of reliable service. By saving energy, your thermostat will pay for itself during its first season of use. Thank you for buying our product!

Please read this manual for complete instructions on installing and operating your thermostat. If you require further assistance, please feel free to contact us.

### IMPORTANT INFORMATION

#### 1. This thermostat is designed to work on the following systems:

- Gas – Standing Pilot
- Gas – Electronic Ignition
- Gas – Fired Boilers
- Gas – Millivolt Systems
- Oil – Fired Boilers
- Oil – Fired Furnace
- Single Stage Heat Pumps – with no auxiliary heat
- Electric Air Conditioning
- Electric Furnace

This thermostat will NOT control multi-stage heat pumps or 110/220V baseboard electric heating systems.

#### 2. Temperature Range

This thermostat can be programmed between 45°F and 95°F (7°C and 35°C). However, it will display room temperatures from 30°F to 99°F (0°C and 37°C). HI will be displayed if the temperature is higher than 99°F (37°C), and LO will be displayed if the temperature is lower than 30°F (0°C).

This thermostat will automatically shut down in Heat mode if the temperature rises above 95°F (35°C), and will automatically shut down in Cool mode if the temperature drops below 45°F (7°C).

#### 3. Compressor Protection

After shutting off the cooling system, this thermostat has a 4 minute delay before it can be restarted. This feature will prevent damage to your compressor caused by rapid cycling. It does not prevent a rapid compressor restart due to short power outages.

#### 4. Battery Warning

Two fresh AA alkaline batteries should provide over one year of service. When the batteries need to be replaced. The low battery indicator will flash on the display. When you see this message, install new alkaline batteries. You have approximately 1 minute to change the batteries and keep the thermostat's clock and program settings. Once the batteries have become too low to ensure proper operation, your system will be turned off, and the display will be cleared except for flashing Low Battery Indicator on the LCD display.

**CAUTION:** When only the Low Battery icon flashes on the display, the thermostat is shut down, and your system will no longer operate. In this condition, there is no temperature control.

**NOTE:** The backlight will not function when the thermostat is in low battery condition.

**NOTE:** If you plan to be away from the premises over 30 days, we recommend that you replace the old batteries with new alkaline batteries prior to leaving.

### FEATURES

Structure of thermostat and explanation of the keypads

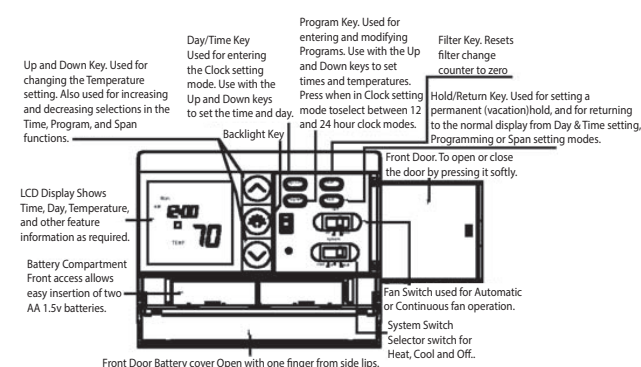

### OPERATION

#### Setting Day and Time

- The LCD will show this information when batteries are first installed.
- The temperature will update after a few seconds.
- During time and day setting mode, the temperature and program displays will go blank.

Refer to the Steps below.

#### STEP 1:

- Press to enter time and day setting mode. The current hour and the AM/PM indicator will be flashing.
- Press up or down to change the hour to the current hour.

Note the AM/PM indicator, as the display will change at 12AM and 12PM.

#### STEP 2:

- Press again to change from hour setting to minute setting. The current minute will be flashing.
- Press up or down to change the minute to the current minute.

#### STEP 3:

- Press again to change from minute setting to day setting. The current day will be flashing.
- Press up or down to change the day to the current day.

#### STEP 4:

- Press again to change back to the normal display.

**NOTE:** You may press **hold** at any time during day and time setting to return to the normal display.

#### 12Hr. / 24 Hr. Time Format

Your thermostat is set from the factory in normal 12 (AM/PM) time format. To change to 24 hour (military) time, press **program** during time and day setting mode to toggle between the 12 hour and 24 hour formats. The AM / PM indicator will not be displayed in 24 hour mode. Both the current time and all programs will automatically change to the selected format.

### PROGRAMMING

The following time and temperature settings are pre-programmed into the thermostat:

Program Number	Time	Temperature in F° (C°)	
		Heat	Cool
1	6:00 am	68°F(20°C)	78°F(26°C)
2	8:00 am	60°F(16°C)	85°F(29°C)
3	4:00 pm	68°F(20°C)	78°F(26°C)
4	10:00 pm	60°F(16°C)	82°F(28°C)

- All 7 days of the week have the same default programs.

#### Personal Program Schedule

- You can revise the factory programs to match your own schedule. Use this Personal Program Schedule to determine which times and temperature settings match your comfort and energy saving requirements. Use a pencil so you can revise your records each time you change your program settings.

#### Heating

Day	Program 1	Program 2	Program 3	Program 4
Monday – Friday	Time Temp	Time Temp	Time Temp	Time Temp
Saturday – Sunday	Time Temp	Time Temp	Time Temp	Time Temp

#### Cooling

Day	Program 1	Program 2	Program 3	Program 4
Monday – Friday	Time Temp	Time Temp	Time Temp	Time Temp
Saturday – Sunday	Time Temp	Time Temp	Time Temp	Time Temp

#### Revising Programs

- Familiarize yourself with manually changing programs, so that you can easily modify the programs as your comfort needs change. Follow the steps below to change the program times and temperature.

#### NOTE:

- 1) The program time can be set in 10-minute increments.
- 2) The program temperature can be set in increments of 1°F (1°C).
- 3) After 15 seconds without a key press, the thermostat will return to normal display mode.
- 4) When setting the program time, note the AM / PM indicator.

#### STEP 1:

- Slide the System Switch to the HEAT or COOL position to program the corresponding system.

**NOTE:** If the System Switch is in the OFF position, the last position used will be programmed.

#### STEP 2:

- Press to enter program mode. HEAT or COOL will be displayed on the LCD.

#### STEP 3:

- The program hour and AM or PM indicator will flash. Press to change the hour.

#### STEP 4:

- Press again to change to the minute position. The current minute will flash.
- Press to change the minute.

#### STEP 5:

- Press again to change to the program temperature. The current program will flash.
- Press to change the temperature.

#### STEP 6:

- Press again to move to the next program number.
- Repeat Step 3 through 5 to change the remaining weekday and weekend programs. (There are a total of 8 programs.)

- After cycling through all 8 programs, press again to return the display to normal.
- Press at any time to exit the program mode.

#### Reviewing Programs

To review your program settings, press **program** repeatedly to cycle through the programs. You also can make changes at any time.

#### System Selector Switch

The System Selector switch on the front of the thermostat determines the operating mode of the thermostat. You may select COOL, OFF, or HEAT.

**NOTE:** Anytime you install or remove the thermostat from the wallplate, slide the System Selector to the OFF position to prevent rapid system On-Off.

#### Fan Switch

The fan switch should normally be set in the AUTO position. The fan will be turned on during normal operation of your system. In a normal gas or oil furnace, the fan will be turned on by your furnace after its warm-up delay. For electric heat, air conditioning, and heat pump operation, the fan will turn on with the system.

To run the fan continuously, slide the Fan switch to the ON position.

#### Temporary Manual Override

To temporarily change the current set temperature without affecting your program:

- Press and hold for about 1 second to enter Manual Override mode. When display flashes, you can release the key.
- Press again to change to your desired set temperature. Hold the key for 2 seconds to fast-advance set temperature.

- Press to return to normal mode, or wait 5 seconds for it to return automatically.
- The current program number will flash to signify the temporary override.
- At the next program change time, the temporary override is canceled, and the next program temperature becomes the setpoint temperature.

- Press, then press again. This will return the set temperature to the current program set temperature.

#### Permanent Override or a Designated Day Override



To hold your manual override for vacation or until a designated day.

- Press to make the current program temperature the HOLD temperature. HOLD will be displayed on the LCD, and the program number will disappear.

- Follow the Temporary Manual Override instructions above to change the Permanent Manual Override temperature.

- You can confirm the held set temperature by pressing for less than 1 second.







-  Press again. Hold day will be displayed on the LCD and the clock will disappear
-  Press day key to add override days. Press Program key to reduce override days.
-  Follow the Temporary / Designated Day Override instructions above to change the Permanent Manual Override temperature.

#### To End Override:

-  Under Permanent Override press hold/return key twice. Under a Designated Day Override press the hold once. The thermostat will return to the current program, and the HOLD display will be canceled.



#### Filter Change Indicator

Your thermostat also keeps a record of the number of hours your filter has been in use. To maximize your system's performance and energy efficiency, change or clean your filter regularly.

-  When the total system runtime for heat and cool reaches 400 hours, FILT will alternate with the current time on the LCD display to remind you to clean or change your system's filter. FILT will continue to flash until the counter is set back to zero. 
-  Press to review total filter usage. The display will blink FILT, then show the filter monitor counter. After 15 seconds, the display will return to normal mode. In this example, the counter is at 410 Hours, 26 Minutes. 
- After changing or cleaning the system filter, press and release the Filter Button. The usage hours will display on the screen. Reset the display by pressing and holding the Filter Button again until the hours displayed are zero (0).

#### DIFF Setting

Your thermostat is set at the factory to cycle at 2°F (1°C) above and below the set temperature (DIFF = 2). This setting has been designed to provide a comfortable room temperature under most conditions. However, if you find your system cycling too often, the DIFF can be adjusted to modify the cycle time.

-  Press and hold BOTH up and down keys for three seconds. The display will flash, and DIFF will be displayed on the LCD.
- Press the up key to raise the DIFF to 3. This setting INCREASES to cycle time by allowing your system to run LONGER.
-  Press the down key to lower the DIFF to 1. This setting DECREASES the cycle time by causing your system to run SHORTER.

The DIFF settings remain the same for both HEAT and COOL. The DIFF can be changed at any time and is independent of program times or temperatures. When batteries are installed in the thermostat, the DIFF is reset back to Setting 2.

#### Backlighting

Your thermostat has an electroluminescent lamp that backlights the display for easy viewing in the dark. When any key is pressed, the display is illuminated.

The display will remain illuminated for 8 seconds after the last key is pressed. This allows the light to stay on if you need to operate several keys.

**Note:** If the thermostat is in Low Battery warning condition, the backlight will not operate. Replace with 2 new AA alkaline batteries to restore the backlight function.

#### Low Battery Warning

Your thermostat has a two-stage low battery warning system. When the batteries are first detected to be weak, the first stage low battery warning is indicated by a battery symbol flashing on the LCD display. At your earliest convenience, you need to replace the batteries with 2 new AA alkaline batteries.

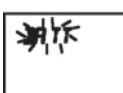

When the batteries become too weak for normal operation, the thermostat enters the second stage low battery warning which shuts down the thermostat. In this condition, BATT flashes alone on the display, and the thermostat will turn your system off. Your system will remain shut off until the batteries are replaced.

**Note:** The thermostat will still keep the current set temperature and filter run time in memory until new batteries are installed. After confirming that new batteries have been inserted, the thermostat will return to normal operation.

#### Auto Recovery

Auto Recovery calculates how early to turn your system back on, so the room temperature is comfortable by the start of the comfort temperature program period. Auto Recovery works in both heat and cool modes.



- When the thermostat is in Auto Recovery mode, the display will alternate RECO with the time, and the program indicator will flash.
- Auto Recovery can be disabled by sliding the Recovery switch on the circuit board to disable.
- Auto Recovery will not operate if Permanent Hold or Temporary Hold is in operation.
- Auto Recovery can be canceled manually if HOLD/RETURN is pressed during the recovery process.
- Auto Recovery will be canceled and the thermostat will change to next period.

#### Error Mode

If the thermostat is unable to control your system due to a battery problem, the thermostat will enter Error Mode. In this condition, the thermostat flashes E1 or E2 on the LCD display, and shuts off your system. To correct this problem, replace the batteries with 2 new AA alkaline batteries, even if you have recently replaced them. Remove the battery, hold any key, then replace the battery again. You will need to reprogram your thermostat and confirm normal operation.



If Error Mode returns, please contact us for further information.

LCD Display	Information	LCD Display	Information
E1	Sensor error	E2	System switch error

#### Auto Cut Off

Your thermostat will automatically shut down in Heat mode if the room temperature rises above 95°F (35°C). It will shut down in Cool mode if the room temperature drops below 45°F (7°C).

**Note:** If your system has malfunctioned and no longer responds to thermostat controls, the Auto Cut-Off will have no effect.

#### Mechanical Heat Backup

This thermostat includes a bimetal switch that will automatically turn on the heat when the temperature reaches about 41°F (5°C).

**WARNING:** This switch only activates the heating terminal (W). The system itself must be capable of automatically turning the fan on. Without normal fan operation, severe damage to the heating system could result.

#### Selector Switches

In order for this thermostat to control your system, the system type must be specified by the selector switches on the printed circuit board inside the thermostat. There is also a selector switch for your choice of Fahrenheit or Celsius temperature display.

- F° / C° selector (Fahrenheit / Celsius)

Your thermostat is set for F° from the factory. In order to change to C°, slide the switch to C°, remove the batteries, wait for about 1 minute, then replace the batteries.

**NOTE:** You must press and hold any key about 2 seconds when the batteries is out, then replace the battery or the thermostat will not change temperature mode and all programs and settings will be lost.

- Heating System Selector (HG – HE switch)

The factory position for this switch is in the HG position. Leave it in this position if you have a gas furnace or an oil burner. If you have an electric furnace, test to see whether the heat and fan come on as expected after installation. If the fan operation is normal, leave it in the HG position. If the fan does not come on within a minute of the thermostat calling for heat, change the switch position to HE. The system selector has no effect in the cooling mode.

**NOTE:** HG position is for gas and most other systems. HE position is for certain electric systems having a fan relay.

- System Selector (STANDARD – HEAT PUMP switch)

The factory position for this switch is in the STD position. Leave it in this position if you have ANY system that uses gas, oil, electric, or hot water heating. If you have a single stage heat pump (no auxiliary or emergency heat source), then slide the switch to the HP position. Be sure the reversing valve wire is connected to the correct terminal for your heat pump (Y/O) or (W/B).

- Auto Recovery Selector (DISABLE/ENABLE)

Your thermostat is set from the factory with the Auto Recovery Feature enabled, which complies with the EPA ENERGY STAR Program. If you prefer to use normal recovery, slide the switch to the DISABLE position.

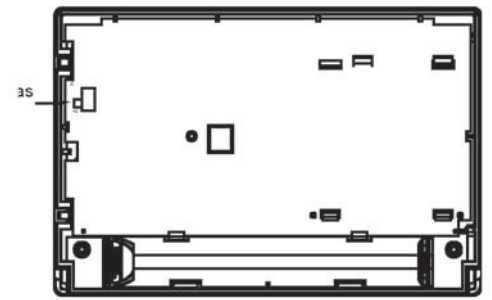

#### INSTALLATION

##### What You Need

This thermostat includes two #8 slotted screws and two wall anchors for mounting. To install your thermostat, you should have the following tools and materials.

- Slotted screwdriver(s)
- Small Philips screwdriver
- Hammer
- Electric drill and 3/16" bit
- Two 1.5V (AA) size alkaline batteries (included)

##### Remove Old Thermostat

**CAUTION:** Do not remove any wiring from existing thermostat before reading the instructions carefully. Wires must be labeled prior to removal.

**IMPORTANT!** Turn off the power to the furnace at the main power panel or at the furnace.

Remove existing thermostat cover and thermostat. See Figure 1. Some thermostats will have screws that must first be removed. Once the wall mounting plate is exposed, look for wires. If wires are not visible, they may be connected to the back of the wall plate. Again, look for screws, tabs, etc. Some models have doors that open to expose wires and mounting screws. See Figure 1.

##### Typical Home Thermostats

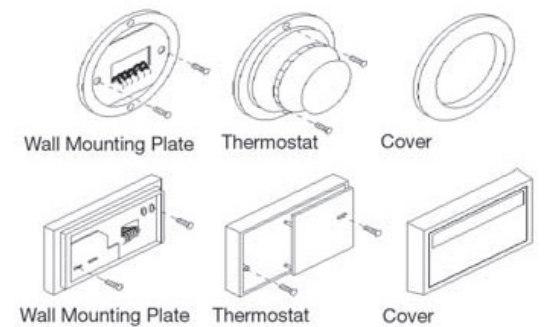
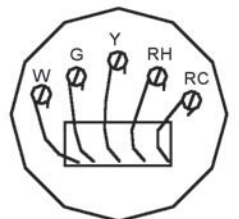

Figure 1.

##### Wiring Labeling

- Each wire coming from the wall to the existing thermostat is connected to a terminal point on that thermostat. Each of these terminal points is usually marked with a code letter as shown in Table A below.
- Note that this thermostat has multiple function terminals that allow single stage heat pump capability. Standard systems use: Rh, Rc, G, Y, W. Single stage heat pumps use: R, Y, G, and O or B. Table A below shows the multiple functions of the terminals. Use the terminals that match your system.
- The number of wires in your system can be as few as two (for heat only systems), as many as eight, or any number in between. If you follow the labeling procedures correctly, you do not have to be concerned about how many wires there are.
- There is often no terminal marking on the existing thermostat of two wire, heat only systems. Just connect either of the wires to the RH terminal, then connect the other wire to the W terminal to complete the circuit.



**IMPORTANT! BEFORE DISCONNECTING ANY WIRES, APPLY THE SELF-ADHESIVE LABELS PROVIDED TO THE WIRE AS SHOWN IN TABLE A BELOW.** For example, attach the label marked W to the wire that goes to the W or H terminal on your existing thermostat. IGNORE THE COLOR OF THE WIRES since these do not always comply with the standard.

- After labeling wires, disconnect them from the existing thermostat.
- Remove existing wall plate. To make sure wires do not fall back into wall opening, you may want to tape them to the wall.
- If hole in wall is larger than necessary for wires, seal this hole with insulating material so that no hot or cold air can enter the back of the thermostat from the wall. This air could cause a false thermostat reading.



If the code letter on your existing Thermostat is:	Then mark the wire with label shown	And connect to thermostat terminal shown
RH, R, VR or 4 24 Volt		
RC, VC 24 Volt Cool		
G or F Fan		
Y, C or M Air Conditioning Compressor - or - O Reversing Valve operating in Cool mode. (Single Stage Heat Pumps ONLY)		
W or H Heating - or - B Reversing Valve operating in Heat mode. (Single Stage Heat Pumps ONLY)		
Y1 Heat Pump Compressor (Single Stage Heat Pumps ONLY)		

**NOTE:** Do not connect a Common wire (sometimes labeled C) to any terminal on this thermostat. Tape up the wire and do not use. This wire provides electricity to non-battery powered thermostats.

#### Mount Wallplate and Thermostat

- Remove the wall plate from your thermostat by pressing the release tab on the bottom of the thermostat. See Figure 2.

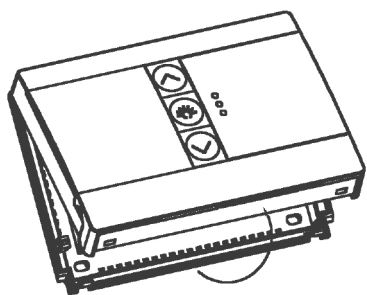

Figure 2.

- Position wallplate on wall and pull existing wires through large opening. Then level for appearance. Mark holes for plastic anchors provided if your existing holes do not line up with those on the wall plate.
- Drill holes with 3/16" bit and gently tap anchors into the holes until flush with wall.
- Reposition wallplate to wall, pulling wires through large opening. Insert mounting screws provided into wall anchor and tighten. See Figure 3.

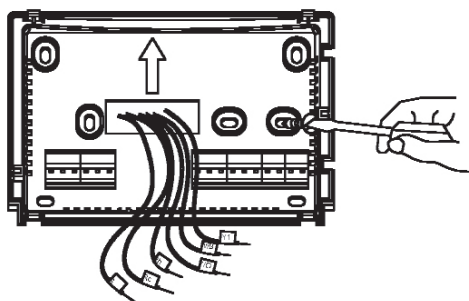

Figure 3.

#### NOTE: 5-Wire Systems

If your thermostat has one wire marked R or Rh (2, 3, or 4-wire system), then leave the jumper wire between the Rh and Rc terminals on the wallplate. Otherwise, if you have separate Rh and Rc wires (5-wire system), then remove the jumper wire between the Rh and Rc terminals.

#### Connect Wires and Mount Thermostat to Wallplate

- Match and connect the labeled wires to the appropriate coded terminal screws on the wallplate. (See Figure 4 and 5.) Ignore any wires which may be present, but which were not connected to the old thermostat.
- Refer to the Wiring Diagrams below to be sure your system is wired correctly.
- If your system is a single stage heat pump and uses an O or B wire, you must move the System Selector switch inside the thermostat to the heat pump (HP) position. If you have a normal furnace or electric system, leave the switch in the Standard (STD) position. Refer to the System Selector section for more information on this switch.
- Be sure to tighten the terminal screws securely, otherwise a loose wire could cause operational problems with your system or thermostat.
- Push excess wires back into the hole to prevent interference when installing the thermostat to the wallplate.
- Make sure the System switch is set to OFF, and the Fan switch is set to AUTO.

- Insert the bottom tabs on the thermostat body into the slots at the bottom of the wallplate. Press the top of the thermostat body to snap it into the wallplate. Refer to Figure 6.

**NOTE:** Do not force the thermostat onto the wallplate, as the terminal pins may be damaged. If it does not snap properly, the thermostat may not work.

- Insert the two AA size alkaline batteries, observing the polarity marked inside the battery compartment.

- Switch on the main power at the panel or furnace.

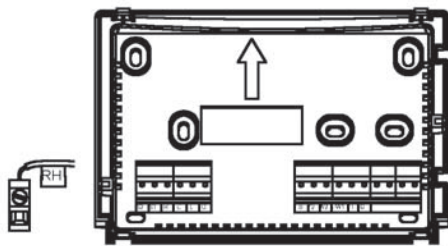

Figure 4.

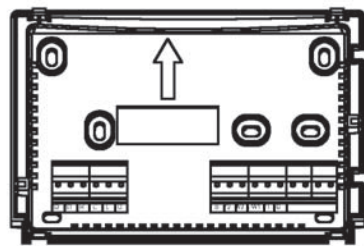

Figure 5.

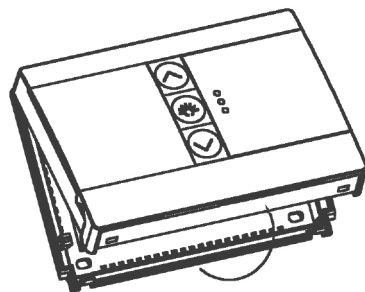
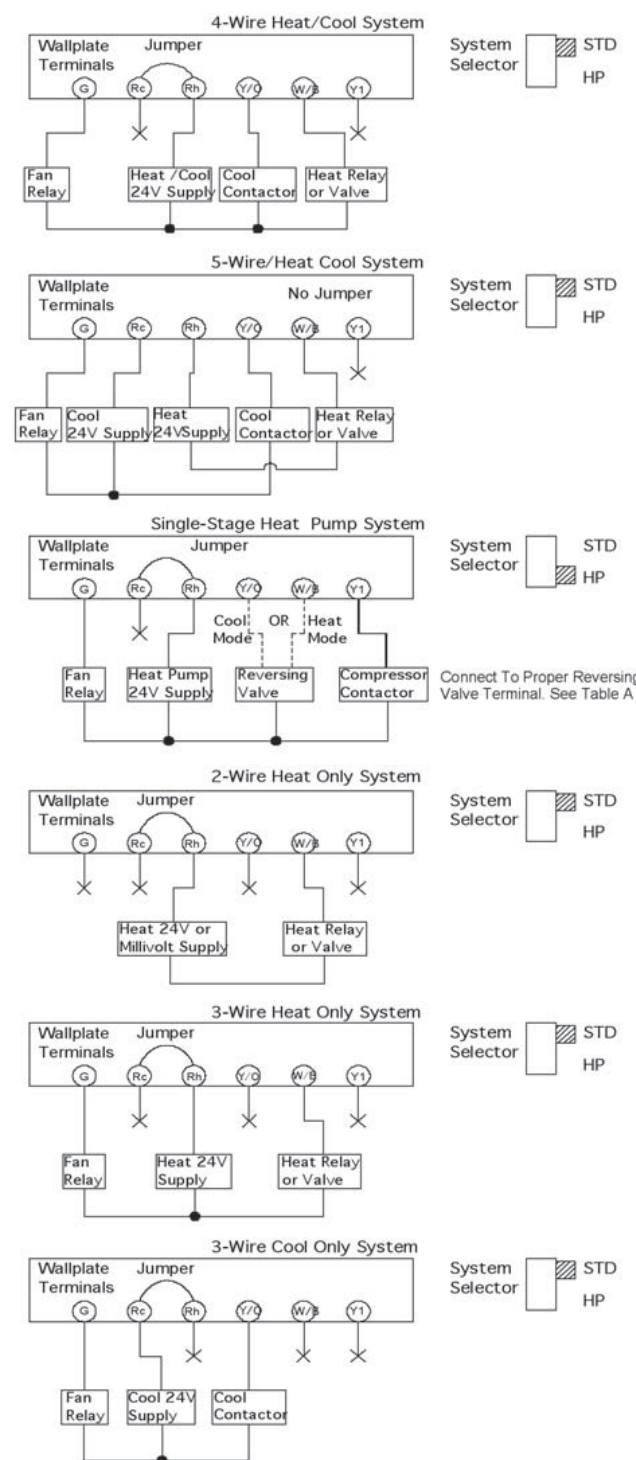

Figure 6.

#### Wiring Diagrams



TROUBLESHOOTING	
Problem	Solution
No display	1. Check battery connections and batteries. 2. Remove the battery and wait for about 1 minute, then replace batteries.
Entire display dims	1. Replace batteries.
Auto fan does not turn on properly	1. Move HG/HE selector to correct position.
Heating or cooling does not go on or off	1. Check that the System switch is in the correct position (HEAT or COOL). 2. There may be as much as a 4-minute delay before the system turns on – wait and check (Compressor protection delay). 3. Check your circuit breakers and switches to ensure there is power to the system. 4. Replace batteries. 5. Make sure your furnace blower door is closed properly. 6. If your non-heat pump system only uses 4 wires, be sure the jumper wire is installed between the Rh/B and Rc/O terminals. 7. Check the position of the System selector switch: Standard or Heat Pump. 8. If you have single stage heat pump, be sure the jumper wire is installed between the Y and W terminals.
Erratic display	1. Remove the battery, hold any key then replace the battery. Reprogram.
Unit continues to operate in the OFF position	1. Replace unit.
Thermostat permanently reads HI, LO, or Er	1. Replace unit.

If you experience any other problems, contact Technical Support service at: [TechnicalService@robertshaw.com](mailto:TechnicalService@robertshaw.com) or (800) 445-8299.

#### Two Year Limited Warranty

Robertshaw warrants to the original contractor installer or to the original consumer user that each new PerfectSense Product shall be free from defects in materials and workmanship under normal use and service for a period of two (2) years from the date of manufacture ("Warranty Period"). If any Product fails within the applicable Warranty Period, Robertshaw shall, at its sole option, repair or replace the Product, provided that the Product is returned to Robertshaw facility or designated agent within the Warranty Period, with transportation charges prepaid, and that the Product, upon examination by Robertshaw, is found to conform to this warranty. The above warranty does not apply to: i) batteries; ii) improper installation; iii) Products that have been damaged, misused, neglected, mishandled, or altered in any manner whatsoever, and/or; iv) defects or damage that result from use of the Product in other than its normal and customary manner or in any manner not in accordance with Robertshaw recommendations and/or instructions. Any and all costs of labor, thermostat removal, or reinstallation are not covered under this warranty and shall be the sole responsibility of the consumer or installer, as applicable.

THE FOREGOING WARRANTY IS IN LIEU OF AND EXCLUDES ALL OTHER WARRANTIES, WHETHER VERBAL OR WRITTEN, EXPRESS OR IMPLIED INCLUDING, EXCEPT TO THE EXTENT PROHIBITED BY APPLICABLE LAW, THE IMPLIED WARRANTIES OF MERCHANTABILITY AND FITNESS FOR A PARTICULAR PURPOSE. IN NO EVENT SHALL ROBERTSHAW BE LIABLE TO CONSUMER, CONTRACTOR OR ANY THIRD PARTY FOR ANY CONSEQUENTIAL, INCIDENTAL, SPECIAL OR PUNITIVE DAMAGES ARISING FROM OR RELATING TO USE OF THE PRODUCT INCLUDING, BUT NOT LIMITED TO, LOSS OF GOODWILL, LOSS OF PROFIT OR REVENUE, AND PROPERTY DAMAGE, REGARDLESS WHETHER SUCH LOSS OR DAMAGE IS BASED IN CONTRACT, WARRANTY, TORT, NEGLIGENCE, STRICT LIABILITY, INDEMNITY, PRODUCT LIABILITY, OR OTHERWISE AND EVEN IF ROBERTSHAW HAS BEEN ADVISED OF THE POSSIBILITY OF SUCH DAMAGES.

**UNI-LINE**

Customer Service Telephone 1.800.304.6563  
Customer Service Facsimile 1.800.426.0804  
[HVACCustomerService@robertshaw.com](mailto:HVACCustomerService@robertshaw.com)

For Technical Service  
Telephone 1.800.445.8299  
[TechnicalService@robertshaw.com](mailto:TechnicalService@robertshaw.com)

Robertshaw®, Uni-Line® and PerfectSense™ are trademarks of Robertshaw, its subsidiaries and/or affiliated companies. All other brands mentioned may be the trademarks of their respective owners.

[www.uni-line.com](http://www.uni-line.com)  
[www.robertshaw.com](http://www.robertshaw.com)  
©2015 Robertshaw  
10/15 – 352-00239-001