

Installation and Service Instructions

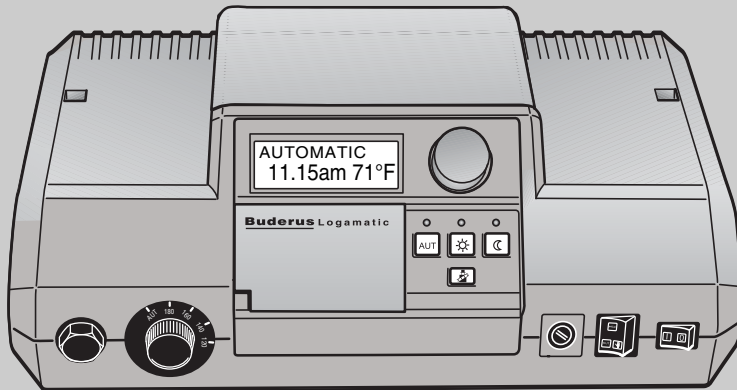

Boiler Controls Logamatic 2107

For the installing contractor

Please read carefully prior
to commissioning or
servicing.



This product has been tested and is certified for both the US and Canadian markets and meets all applicable US and Canadian standards.

Notice:

To match the typical building, the following factory settings may need adjustment:

- BLDG RESP:** Change to 1 if typical 2x4 or 2x6 construction
- MAX TEMP:** Change to 185-190°F if high temperature baseboard is used
- OASETBACK:** Change to SETBACK if no room sensor is being used or RMSETBACK if a room sensor is present

Refer to page 10 for additional details.

1	Safety instructions and user notes	. 5
1.1	Intended use	. 5
1.2	Hazard symbols	. 5
1.3	Please observe these safety instructions	. 6
2	Setting parameters and display data for the Logamatic 2107	. 7
3	Installation	. 9
3.1	Mounting of the Logamatic	. 9
3.2	Installation of the Logabacket	. 11
4	Logamatic 2107 controls	. 12
5	Checking the manual reset high limit (STB)	. 15
6	Using the service level	. 17
6.1	Calling up the service level	. 17
6.2	Calling up the menu	. 18
6.3	Modifying settings	. 19
7	General data	. 20
7.1	System frost protection	. 21
7.2	Type of building	. 22
7.3	Setting the burner type	. 24
7.4	Minimum modulating output of the modulating burner	. 25
7.5	Operating time of the modulating burner actuator	. 26
7.6	Pump logic	. 27
7.7	Maximum boiler temperature	. 28
7.8	Language selection	. 29
8	Heating circuit data	. 30
8.1	Heating system	. 30
8.2	Reference design temperature	. 33
8.3	DHW priority	. 35
8.4	Maximum heating circuit temperature	. 36
8.5	Remote control ON/OFF	. 37
8.6	Maximum room temperature compensation	. 39
8.7	Setback mode selection	. 41
8.8	Room temperature offset	. 43
9	Solar data	. 44
9.1	Solar function ON/OFF (with FM 244 only)	. 44
9.2	Maximum storage tank temperature in solar mode	. 45
9.3	Minimum storage tank temperature in solar mode	. 46

10	DHW production ON/OFF	47
11	DHW recirculation pump	48
12	Heating curve	50
13	Running the relay test	51
14	Performing an LCD test	53
15	Time, correcting the accuracy	54
16	Reset	55
17	Version number	56
18	Sensor curves	57
19	Operating values at the service level/setup report	59
20	Troubleshooting	61
	20.1 Troubleshooting "NO HEAT" call.	63
	20.2 Troubleshooting „INSUFFICIENT HEAT“ call	66
	20.3 Troubleshooting Domestic Hot Water.	67
21	Index	68

1 Safety instructions and user notes

This chapter contains general safety instructions, which you should observe when installing and servicing the Logamatic 2107 controls.

The other safety instructions that appear in other sections of these service instructions must also be followed exactly. The safety instructions always precede the individual tasks. Read the safety instructions carefully before carrying out the tasks described below.

The result of ignoring safety instructions can be severe injury or even death, as well as damage to property and the environment.

1.1 Intended use

Logamatic 2107 controls are used to control and monitor heating systems in detached and terraced houses. The Logamatic 2107 controls can be used to check and set the room and DHW temperatures and to select and set heating programs.

1.2 Hazard symbols

All safety instructions in these service instructions are identified by the danger sign. A signal word is positioned below this sign, which indicates the level of danger. Always observe the measures prescribed to reduce the risk of danger.



WARNING!

PRIORITY SAFETY INSTRUCTIONS

The term "Warning" refers to dangers, which may lead to injury or death.



WARNING!

HAZARD - ELECTRICAL POWER

This symbol indicates a danger through electrical power.



CAUTION!

SAFETY INSTRUCTION – 2ND PRIORITY

The term "Caution" refers to dangers, which may lead to material losses.



USER NOTE

User notes help you use and handle this technology in the optimum, most economical, safe and environmentally-friendly manner.

1.3 Please observe these safety instructions

The Logamatic 2107 controls has been designed and built in accordance with currently recognized standards and safety requirements.

However, property damage resulting from inappropriate handling of this device cannot be completely excluded.

- Only operate the Logamatic 2107 controls for the intended purpose and when it is in perfect working order.
- Carefully read these service instructions before starting any work on the controls.

Note the following safety instructions while using the Logamatic 2107 controls.



RISK OF LIFE

from electric shock.

WARNING!

- Prior to opening the controls, isolate the system from the mains supply via the boiler emergency shutoff switch or the heating system circuit breaker.
- All tasks listed in these service instructions, which require the opening of the control panel, must only be carried out by trained personnel.



SYSTEM DAMAGE

through frost.

CAUTION!

- Frost protection is only active if the controls is switched ON. Switch OFF the controls and drain the water from the boiler, the DHW tank and the pipes of the heating system. The system is only protected from frost, if it is completely dry.



RISK TO LIFE

- In an emergency, switch OFF the emergency shutoff switch outside the boiler room.

WARNING!



CAUTION!

SYSTEM DAMAGE

through inappropriate work on the system.

- Only enter or change the operating values in accordance with the details shown in these instructions. Other inputs alter the control program of the heating system and can lead to incorrect system functions.

2 Setting parameters and display data for the Logamatic 2107

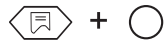

Press the "Display" key and "Install" key at the same time to call up the service level (see Chapter "Keys for extended functions", page 14).

Display		
AMERICAN		Language selection
BOILER		Boiler parameters
FROST AO		Freeze protection limit
BUILDING		Building response
2-STAGE ¹		Burner type ¹
MIN MOD ²		Minimum modulation output ²
TIME RUN ²		Minimum burner run time ²
PUMPLOGIC		Pump logic threshold
MAX TEMP		Maximum boiler switch-off temperature
CIRCUIT 01		Heating circuit 1 installation parameters (unmixed heating circuit)
PERIM HTG		Heating system
REF TEMP		Design temperature
REMOTE 1		Remote control ON/OFF
DIFF T ³		Room temperature hook-up ³
OA SETBACK		Type of setback
OFFSET		Room temperature offset
CIRCUIT 02 ⁵		Heating circuit 2 installation parameters (mixed heating circuit) ⁴
UND-FLOOR		Heating system
REF TEMP		Design temperature
DHW PR ⁵		DHW priority ⁵
MAX TEMP		Maximum heating circuit temperature
REMOTE 2		Remote control ON/OFF
DIFF T ³		Room temperature hook-up ³
OA SETBACK		Type of setback
OFFSET		Room temperature offset

Display

SOLAR ⁷		
	SLR FN ON	Solar function ON/OFF
	MAX SL SR	Maximum storage tank temperature in solar mode
	MIN SL SR	Minimum storage tank temperature in solar mode
DHW PROD		Domestic hot water ON/OFF
RECIRC PUMP ⁵		DHW circulation pump ⁵
HTG CURVE 1		Heating characteristic curve HK1
HTG CURVE 2 ⁴		Heating characteristic curve HK2 ⁴
RELAYS		Relay test
	BURNER (St.1)	Burner relay stage 1
	BURNER2 ¹ , MOD2 ²	Burner relay ¹ stage 2, modulation output ²
	HTG1 PUMP	Heating circuit pump (HZ1 unmixed)
	HTG2 PUMP ⁴	Heating circuit pump (HZ2 mixed) ⁴
	MIX VALVE ⁴	Mixer ⁴
	DHW PUMP	Tank DHW pump
	RECIR PUMP	DHW circulation pump
	SLR PUMP ⁷	Solar pump ⁷
LCD TEST		LCD test
TIME		Time, accuracy
RESET		Reset
VERSION		Version number

1 Only if the FM 242 module is installed and 2-stage burner is selected.

2 Only if the FM 242 module is installed and modulating burner is selected.

3 Only if BFU remote control is installed.

4 Only if the FM 241 module is installed.

5 Only if DHW is installed.

6 Only if FM 241 module is installed and if heating circuit 2 is selected as an "UND-FLOOR" or "RADIATOR" heating system.

7 Only if FM 244 module is installed.

3 Installation

3.1 Mounting of the Logamatic

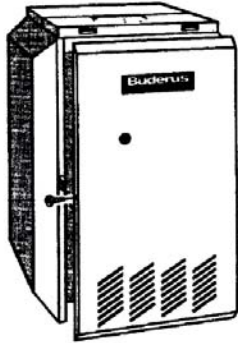

- On the GC124, G124X, GA124, G234X, G244, and G334X boilers remove the front panel of the boiler.
- Remove rear top panel of the boiler by first unscrewing 2 screws at the rear edge, then sliding rear panel backward to disengage the hooks.

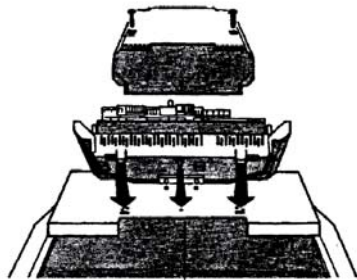

- Remove the two screws at the top of the Logamatic, and lift up top cover.
- Insert the two front feet of the control into the holes provided on the top of the boiler. Then, firmly push down on the rear of the control until it snaps into place.

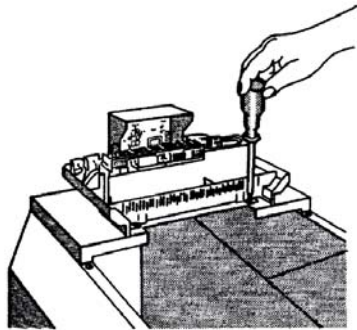

- Fasten the control to the boiler jacket using the two screws as shown.
- The sensor bundle consists of one thermistor (FK), two capillaries and a spacer. Mount the sensors per the following boiler specific instructions. Use the chrome well supplied with the Logamatic.

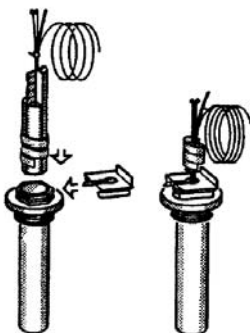

- **G115, G125, GB125, G215, G315:** Replace brass well with chrome Logamatic well. The sensor bundle must be fully inserted into the Logamatic well.
- **GC124, G124X, GA124, GA244, GA334X:** Unwrap the sensor bundle. Remove spacers from the chrome well on the boiler. Remove outer sleeve from one capillary. Insert both capillaries and thermistor into the chrome well together with Honeywell capillary.
- **G234:** The tridicator assembly should be moved to the supply piping and replaced with the chrome plated Logamatic well. The sensor bundle must be inserted into this well.

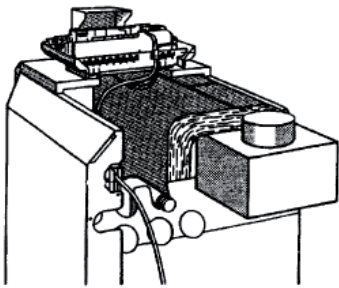

- Electrical connections must be made according to the wiring diagrams.
- All the wires should be routed through the cable raceway at the rear of the boiler. If using conduit install a Logabacket (page 11). The rear panel jacket may be modified per local code. Route the wires on top of the insulation from the back of the boiler to the back of the controls.

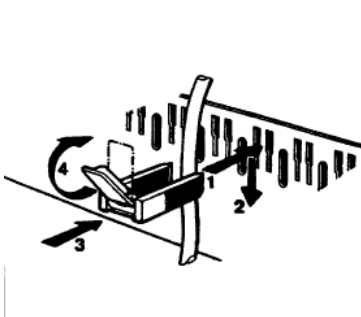

- Use the white strain relief brackets provided to lock all cables into place on the back of the control.

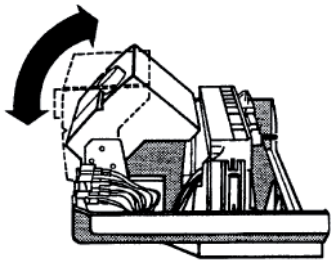

- Tilt the display to the desired position.

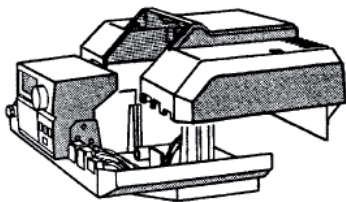

- Replace the top housing of the controls and fasten the two screws. The control is ready to be placed into operation.

3.2 Installation of the Logabacket

The Logabacket is designed to create strain relief for your line voltage and low voltage wiring for the 2107 Logamatic controls. The bracket is mainly designed for use with the G115, G125, GB125 and G124X boilers, but with minor modifications can be used on other boiler models as well.

G115, G125, GB125, G124X, GC124

Line the bracket up with holes, place the Logamatic in place over the holes and secure with screws provided.

Four conduit connections are provided for line voltage wiring; a slotted opening is used to run low voltage sensor wiring.

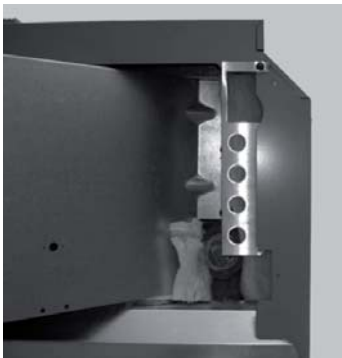
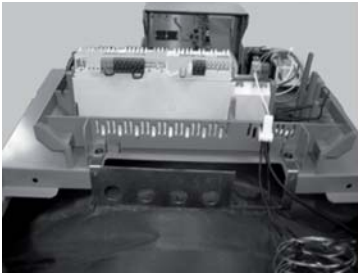
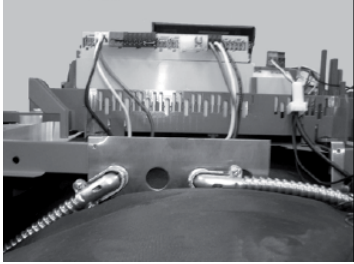

G215

It is necessary to bend down the tabs on the rear jacket panel to prevent interference between bracket and jacket panel.

G234X, G334X

Simply cut off the tabs of the bracket and mount on the rear panel by drilling an additional hole for a second mounting screw.

GA124, GA244

These boilers do not require the bracket as strain relief connections are provided on the rear of the boiler.

4 Logamatic 2107 controls

Introduction to the user interface of the Logamatic 2107 controls.

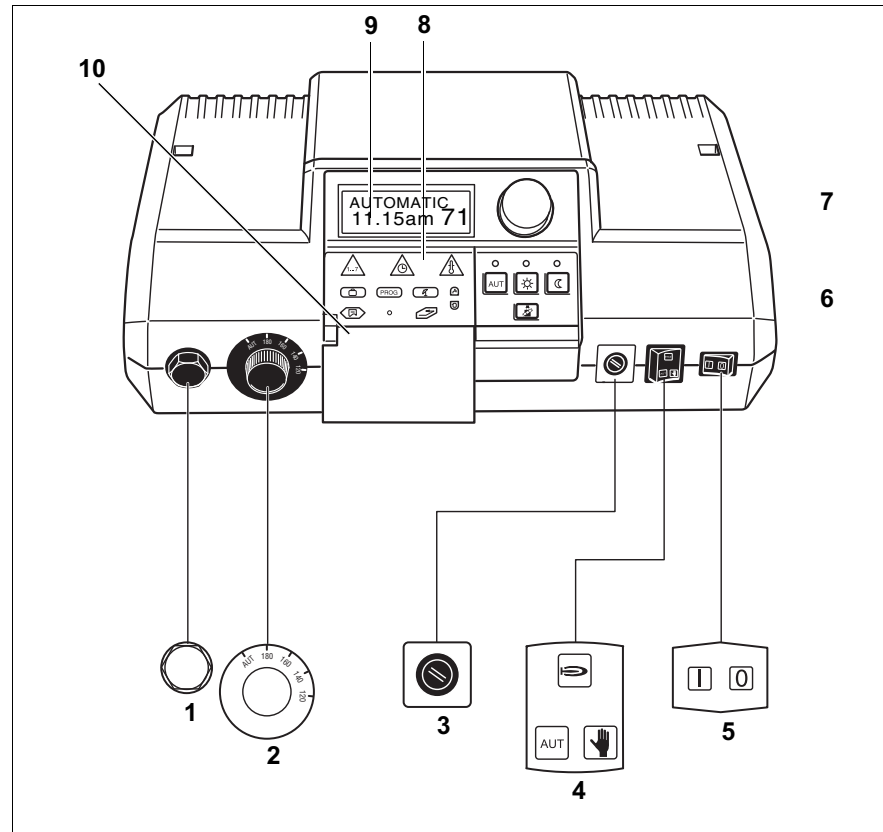

Fig. 1 Controls on the Logamatic 2107 controls

- Item 1:** Manual reset high limit (STB)
- Item 2:** Boiler water thermostat
- Item 3:** Fuse (10 Amp)
- Item 4:** Switch for Automatic mode, Emergency mode
- Item 5:** ON/OFF switch
- Item 6:** Keys for basic functions
- Item 7:** Dial
- Item 8:** Keys for extended functions
- Item 9:** Display
- Item 10:** Flap

Keys for basic functions

You can control the basic functions using this keypad.

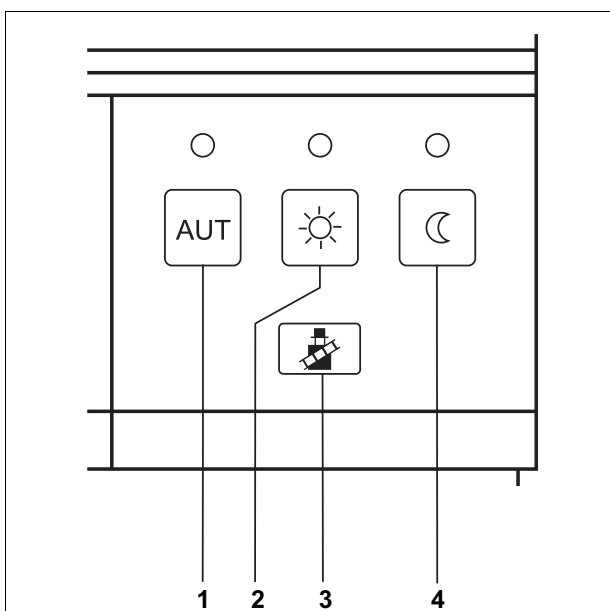

Fig. 2 Keypad for basic functions

- Item 1:** Automatic mode following a program
- Item 2:** Normal heating mode (day mode)
- Item 3:** Flue gas test (for measuring flue gases)
- Item 4:** Setback heating mode (night mode)

Keys for extended functions

This keypad is located behind the flap.

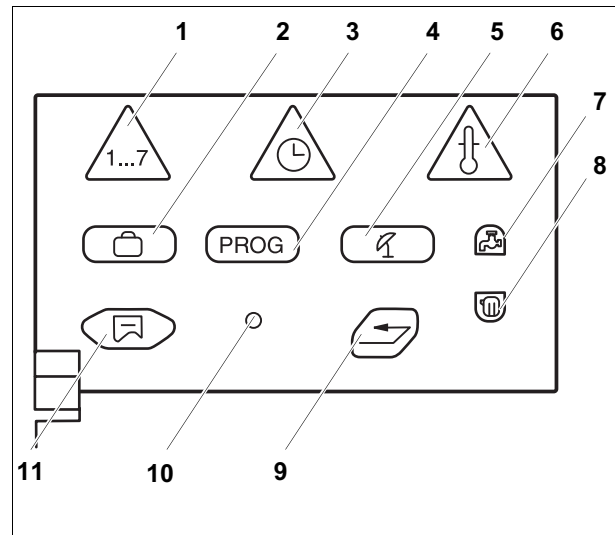

Fig. 3 Keypad for extended functions

Item 1: "Weekday" key – Enter the day of the week

Item 2: "Vacation" key - Set vacation function

Item 3: "Time" key – Set the time

Item 4: "PROG" key – Select program

Item 5: "WWSD" key

Item 6: "Temp" key – Select temperature values

Item 7: "DHW" key – Enter the domestic hot water temperature

Item 8: "Heating circuit" key – Call up the heating circuits

Item 9: "Enter" key – Back to standard display

Item 10: "Install" key – Call up the service level

Item 11: "Display" key – Select the standard display

This keypad is used, for example, to enter the day, set the time, select temperature values, etc.

5 Checking the manual reset high limit (STB)



USER NOTE

Check the STB after the initial installation, and after every service.

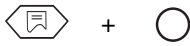

- Switch on the system.
- Press the "Display" key and "Install" key at the same time to call up the service level. "AMERICAN" appears as the first main menu.



Turn the dial until "RELAY" is shown.



Hold down the "Display" key and turn the dial, until "BURNER ON" appears in the display.

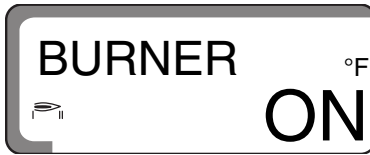

The burner starts running.
Release the "Display" key.

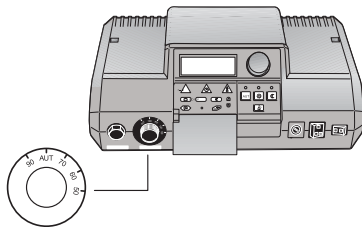

- Remove the dial on the boiler water thermostat (Fig. 4).

Fig. 4 Remove the dial on the boiler aquastat.

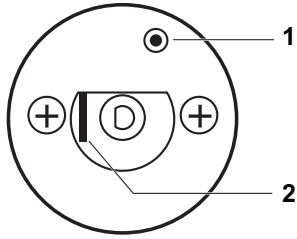

Fig. 5 Triggering the manual reset high limit

Item 1: Key

Item 2: Lever

- Push the lever or key (depending on the type of STB) back with a screwdriver or similar device and hold until the high limit safety cut-out has triggered (Fig. 5).

Terminating or exiting the test

Press "AUT".

Reattach the dial and turn it to the "AUT" position.

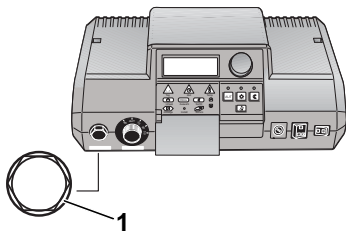

Fig. 6 Remove the STB cover.

Item 1: STB cover.

- To reset the manual reset high limit, remove the cover on the STB and press the reset button located beneath it (Fig. 6).

6 Using the service level

Access to the service level is password protected.

The service level must only be used by trained heating contractors.

Unauthorized access invalidates your warranty.



CAUTION!

SYSTEM DAMAGE

through inappropriate work on the system.

- Only enter or change the operating values in accordance with the details shown in these instructions. Different values will change the heating system control programs and can cause the system to malfunction.

6.1 Calling up the service level

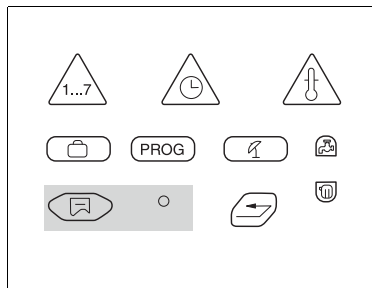

The controls marked in grey are used for this function.

You will need a pointed object, such as a ball-point pen, to press the "Install" button.

Press the "Display" key and "Install" key at the same time to call up the service level.

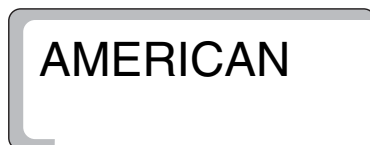
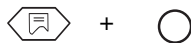

Release both keys. The selected language, e.g. "AMERICAN", is displayed in the first main menu.

The service level is now activated.



USER NOTE

The unit automatically returns to the standard display if no settings are made within 5 minutes.

6.2 Calling up the menu

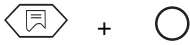

Press the "Display" key and "Install" key at the same time to call up the service level. Release both keys. Once you have called up the service level, you can access all the setting options it contains.

The service level is broken down into main menus and submenus.

You can scroll through the main menu level by turning the dial.

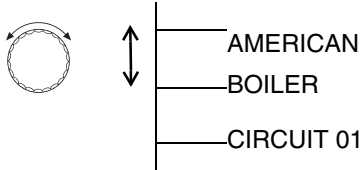

Press the "Display" key to access the submenu.

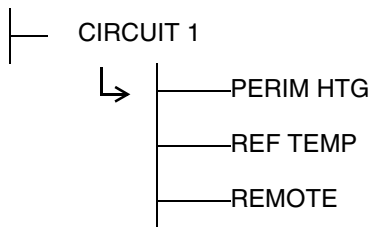

Press the "ENTER" key to return to the higher-level menu.

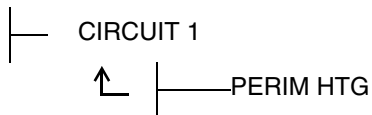

Press the "AUT" key to exit the service level.

6.3 Modifying settings

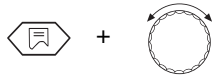

When you press the "Display" key in a submenu, the setting parameter to be changed flashes. Hold down the "Display" key and turn the dial at the same time to change the parameter. The new value will be stored after you release the "Display" key.

Some parameters are only displayed if the relevant modules are installed (module FM 241– mixer, FM 242– 2-stage burner, FM 244 – solar module). The controls detects the modules and enables the parameters.

Return to the standard display



Press "ENTER".

The unit automatically returns to the standard display if no key is pressed within 5 minutes.

7 General data



USER NOTE "PUMP KICK"

In all operating modes, all the pumps are switched on and then off again for 10 seconds every Wednesday at 12 noon to prevent pump damage. This is followed by a brief 5 second pause, then the mixing valves are set to "OPEN" for 3 minutes. All pumps then return to normal operation.

7.1 System frost protection

The controls is equipped with a system frost protection function.

If the outdoor temperature drops beneath the frost protection limit, the heating system pump (contacts 61/63) will be started.

The factory default for the frost protection limit is an outdoor temperature of 41°F (5°C).

The setting applies to all heating circuits.

Changing the system frost protection

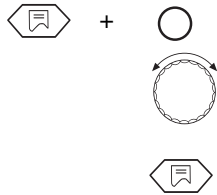

Press the "Display" key and "Install" key at the same time to call up the service level. "AMERICAN" appears as the first main menu.

Turn the dial until "BLR TEMP" is shown.

Press "Display" to call up a submenu. "FREEZE TEMP" appears.

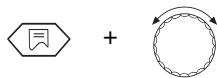
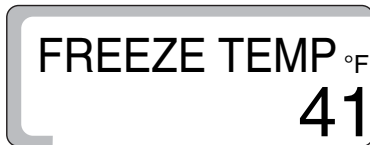

Hold down the "Display" key and turn the dial until the desired value appears (in this case "41°F").

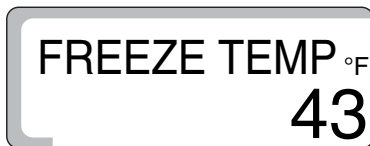

Release "Display" to store your input.



Press "ENTER" to return to the next higher level.



USER NOTE

The value of the "OASETBACK" setback type is also limited to the freeze protection limit. The setting applies to all heating circuits.

	Input range	Factory setting
System frost protection	-4°F – 50°F (-20°C – 10°C)	41°F (5°C)

7.2 Type of building

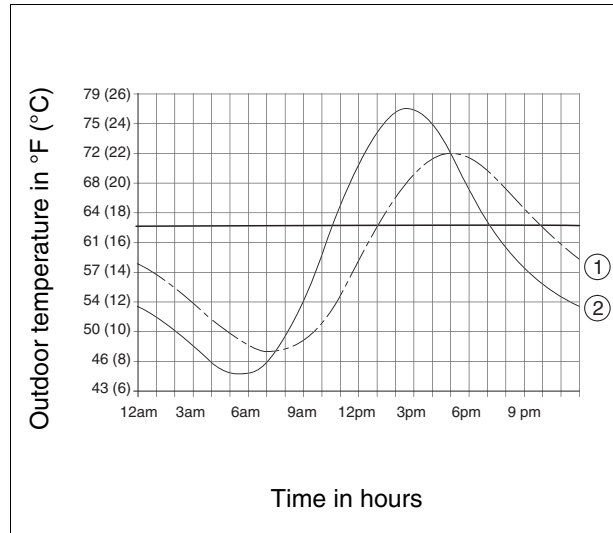

Fig. 7 Thermal delay

Item 1: Current outdoor temperature

Item 2: Adjusted outdoor temperature

The building type is used to take into account the heat storage capacity of the building's mass and the thermal inertia of the building compared to fluctuations in the outdoor temperature. The lighter the building and the thinner its insulation, the faster the controls will respond to changes in outdoor temperature (known as "adjusted outdoor temperature calculation").

It is the adjusted outdoor temperature value that is used for the warm weather shutdown (WWSD) and to calculate the supply temperature using the characteristic heating curve (Fig. 7).

For building type three levels are available:

- Building response 1 (low)
Buildings with small heat storage capacity and low to medium levels of insulation, e.g. 2x4 wood frame or prefabricated construction with typical insulation.
- Building response 2 (medium)
Buildings with medium heat storage capacity and high levels of insulation, e.g. 2x6 wood frame or cinder block construction with above average insulation.
- Building response 3 (high)
Massive buildings with high heat storage capacity and high levels of insulation, e.g. poured concrete, heavy brick or heavy cinder block construction with excellent insulation.

Note: In areas where rapid changes in outdoor temperature occur, choose Building Response 1.

Changing the type of building

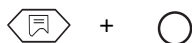

Press the "Display" key and "Install" key at the same time to call up the service level. "AMERICAN" appears as the first main menu.



Turn the dial until "BLR TEMP" is shown.



Press "Display" to call up a submenu. "FREEZE TEMP" appears.



Turn the dial until "BLDG RESP" is shown.



Hold down the "Display" key and turn the dial until the required value appears (in this case "1").



Release "Display" to store your input.



Press "ENTER" to return to the next higher level.

	Input range	Factory setting
Building response	1 (low) 2 (medium) 3 (high)	2

7.3 Setting the burner type

The basic 2107 controls single stage burners. To use it with 2-stage or modulating burners install a FM 242 burner module.

When the FM 242 burner module is installed, the factory default changes from "1-STAGE" to "2-STAGE".

With 2-stage burners, the operating hours are displayed separately for stage 1 and stage 2.

Changing the burner type

Press the "Display" key and "Install" key at the same time to call up the service level. "AMERICAN" appears as the first main menu.

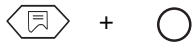

Turn the dial until "BLR TEMP" is shown.



Press "Display" to call up a submenu. "FREEZE TEMP" appears.



Turn the dial until "2-STAGE" is displayed.

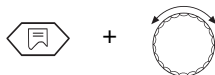
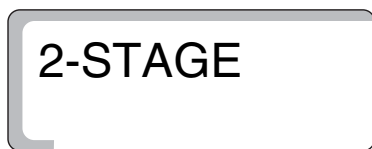

Hold down the "Display" key and turn the dial until the required value appears (in this case "MODULATE") is displayed.

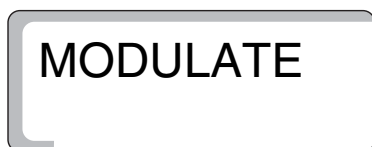

Release "Display" to store your input.



Press "ENTER" to return to the next higher level.

	Input range	Factory setting
Burner system without burner module FM 242	–	1-stage
Burner system with burner module FM 242	1-stage/2-stage/modulating	2-stage

7.4 Minimum modulating output of the modulating burner

The modulating output requires the burner module FM 242 and "MODULATE" burner setting.

The factory default is "30 %", i.e. the burner modulates its set output within an output range of 30-100 %.



USER NOTE

The data can be found in the technical documentation for the installed burner.

Changing the minimum modulation

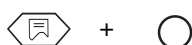

Press the "Display" key and "Install" key at the same time to call up the service level. "AMERICAN" appears as the first main menu.



Turn the dial until "BLR TEMP" is shown.



Press "Display" to call up a submenu. "FREEZE TEMP" appears.



Turn the dial until "MIN MOD" is shown.

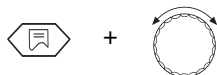
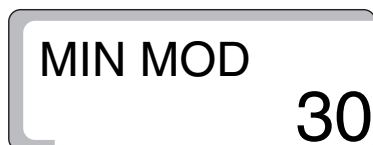

Hold down the "Display" key and turn the dial until the required value appears (in this case "40").

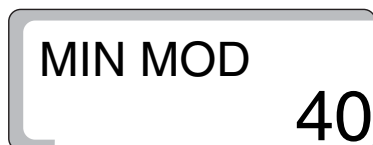

Release "Display" to store your input.



Press "ENTER" to return to the next higher level.

	Input range	Factory setting
minimum modulation output	10 %–60 %	30 %

7.5 Operating time of the modulating burner actuator

This feature requires the burner module FM 242 and "MODULATE" burner setting.

The factory default is "12 seconds".



USER NOTE

The data can be found in the technical documentation for the installed burner.

Changing the operating time of the actuator

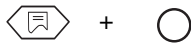

Press the "Display" key and "Install" key at the same time to call up the service level. "AMERICAN" appears as the first main menu.



Turn the dial until "BLR TEMP" is shown.



Press "Display" to call up a submenu. "FREEZE TEMP" appears.



Turn the dial until "MOD TIME" is shown.

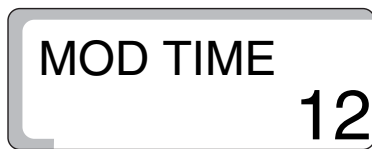

Hold down the "Display" key and turn the dial until the required value appears (in this case "15").



Release "Display" to store your input.



Press "ENTER" to return to the next higher level.

	Input range	Factory setting
Operating time of the actuator	5 – 60 seconds	12 seconds

7.6 Pump logic

To protect the boiler against corrosion from condensation inside the combustion chamber, the boiler pump (while the burner is running) will not start until the boiler water has reached a certain temperature.

The temperature can be set using the "PUMPLOGIC" parameter.

The factory default is 104°F (40°C), which is recommended for cast iron boilers.

Recommendation:

If a condensing boiler is used, the parameter should be set to 60°F (15°C) in order to make optimum use of the condensing technology.

NOTE: The GB125BE requires a pumplogic of 104°F (40°C) due to its cast iron primary heat exchanger.

Changing the pumplogic temperature

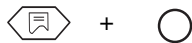

Press the "Display" key and "Install" key at the same time to call up the service level. "AMERICAN" appears as the first main menu.



Turn the dial until "BLR TEMP" is shown.



Press "Display" to call up a submenu. "FREEZE TEMP" appears.



Turn the dial until "PUMPLOGIC" is shown.

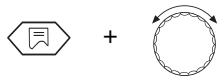

Hold down the "Display" key and turn the dial until the required value appears (in this case 122°F (50°C)).



Release "Display" to store your input.



Press "ENTER" to return to the next higher level.

	Input range	Factory setting
Pump logic for 1-stage 2-stage Modulating burners	60°F – 140°F	104°F (40°C)
	(15°C – 60°C)	113°F (45°C)
		122°F (50°C)

7.7 Maximum boiler temperature

The maximum boiler temperature is the highest target temperature the boiler will reach. The burner should switch off no later than when this temperature is reached (this applies to heating mode and DHW mode).

The factory default is 176°F (80°C).

Changing the maximum OFF temperature

Press the "Display" key and "Install" key at the same time to call up the service level. "AMERICAN" appears as the first main menu.

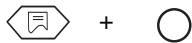

Turn the dial until "BLR TEMP" is shown.



Press "Display" to call up a submenu. "FREEZE TEMP" appears.



Turn the dial until "MAXTEMP 1" is shown.

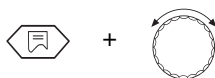
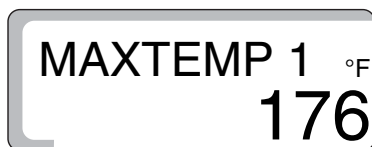

Hold down "Display" and turn the dial until the required value appears (in this case 167°F (75°C)).

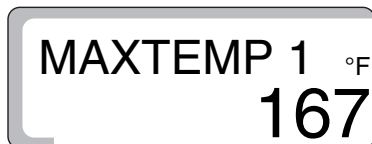

Release "Display" to store your input.



Press "ENTER" to return to the next higher level.



USER NOTE

Ensure that the boiler water aquastat dial is set above the maximum boiler temperature, as it will overwrite the maximum boiler temperature.

	Input range	Factory setting
Maximum OFF temperature	158°F – 210°F (70°C – 99°C)	176°F (80°C)

7.8 Language selection

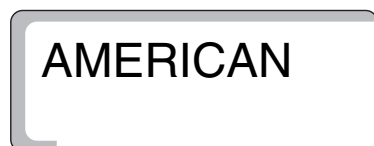

Press the "Display" key and "Install" key at the same time to call up the service level. Release both keys. The selected language, e.g. "AMERICAN", is displayed in the first main menu. The factory setting for the language is "AMERICAN". Now hold down the "Display" key and turn the dial to set the language. Release the "Display" key to store the set language.

8 Heating circuit data

8.1 Heating system

The controls is designed for 2 heating circuits. The basic 2107 supports 1 heating circuit, which can be upgraded to 2 heating circuits using the FM241 card.

- Circuit 01 = unmixed heating circuit, no heating circuit, perimeter heating
- Circuit 02 = mixed heating circuit, no heating circuit, perimeter heating, radiant floor heating

The factory setting is:

Circuit	01	Perimeter heating
Circuit	02	Radiant floor heating

If the right heating system is selected, the other heating circuit parameters are preset. They must still be verified, however.

Further information on this can be found on the next page.

Changing the heating system

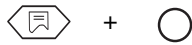

Press the "Display" key and "Install" key at the same time to call up the service level. "AMERICAN" appears as the first main menu.



Turn the dial until "CIRCUIT 01" or "CIRCUIT 02" is displayed.

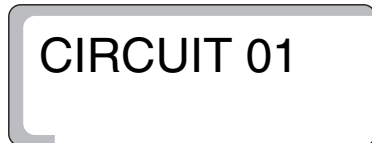

"CIRCUIT 01" setting (heating circuit without mixing valve)



Press "Display" to call up a submenu. "PERIM HTG" appears.

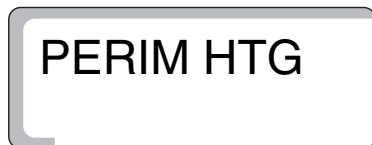

Hold down the "Display" key and turn the dial until the required value appears (in this case "NO SYSTEM") is displayed.

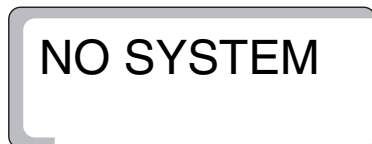

Press "ENTER" to return to the next higher level.



USER NOTE

If there is only one heating circuit with mixing valve present (HK2), circuit 1 must be set to "NO SYSTEM".

If the "NO SYSTEM" setting is used, all of the following settings are hidden for this circuit.

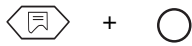

Press the "Display" key and "Install" key at the same time to call up the service level. "AMERICAN" appears as the first main menu.



Turn the dial until "CIRCUIT 01" or "CIRCUIT 02" is displayed.

"CIRCUIT 02" setting (heating circuit with mixing valve)

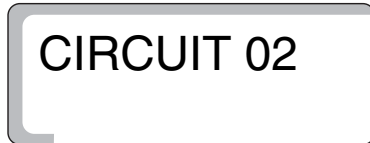

Press "Display" to call up a submenu. "RADIATOR" appears.

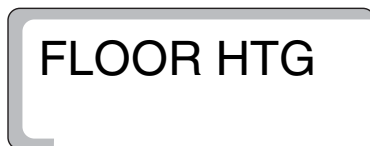

	Input range	Factory setting
Heating circuit 1	NO SYSTEM PERIM HTG	PERIM HTG
Heating circuit 2	NO SYSTEM FLOOR HTG	FLOOR HTG

8.2 Reference design temperature

The reference design temperature is the boiler supply temperature required by the structure and the heating system to achieve the target room temperature at an outdoor temperature of 14°F (-10°C).

The reference design temperature helps define the characteristic heating curve which is the basis for outdoor reset.

It follows the idea that the colder the weather, the greater the heat loss of a structure, and the higher a boiler supply temperature needed to compensate for the resulting losses.

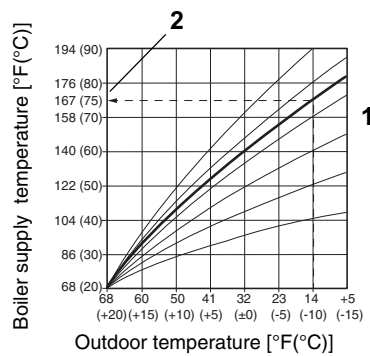

Fig. 8 Determining the heating curve

The factory default setting results in a characteristic heating curve as shown (Fig. 8, **Item 1**).

The reference design temperature (Fig. 8, **Item 2**) is used to adjust the heating curve. Depending on the measured outdoor temperature, the boiler supply temperature is changed in order to keep the room temperature stable and save as much on fuel as possible (Fig. 8).

When changing the reference design temperature, the gradient of the heating curve is adjusted.

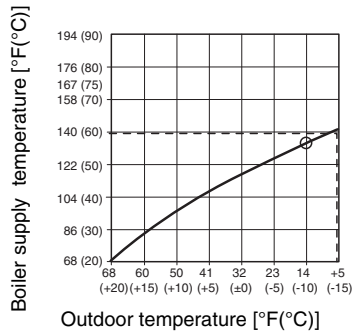

Fig. 9 Determining the heating curve

Example (Fig. 9):

Design temperature 140°F (60 °C) for +5°F (-15 °C) outdoor temperature.

A boiler temperature of 140°F (60°C) is achieved by setting the reference design temperature to 133°F (56°C) (at an outdoor temperature of 14°F (-10°C)),

The reference design temperature can be set from 86 to 194°F (30 to +90°C).

Further information on this can be found on the next page.

The factory setting is:

- With PERIM HTG: 167°F (75°C)
- With FLOOR HTG: 113°F (45°C)

Changing the reference design temperature

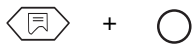

Press the "Display" key and "Install" key at the same time to call up the service level. "AMERICAN" appears as the first main menu.



Turn the dial until "CIRCUIT 01" or "CIRCUIT 02" is displayed.



Press "Display" to call up a submenu. "PERIM HTG" or "FLOOR HTG" appears.



Turn the dial until "REF TEMP" is shown.

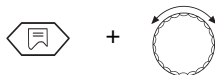

Hold down the "Display" key and turn the dial until the required value appears (in this case 133°F (56°C)).

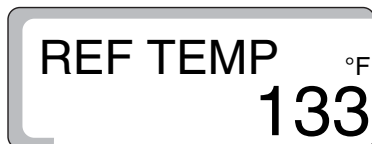

Release "Display" to store your input.



Press "ENTER" to return to the next higher level.

	Input range	Factory setting
Reference design temperature for PERIM HTG	86 – 194°F (30 – 90°C)	167°F (75°C)
Reference design temperature for FLOOR HTG	86 – 140°F (30 – 60°C)	113°F (45°C)

8.3 DHW priority

For the heating circuit 02 with mixing valve (if installed), you can set the DHW priority or DHW heating in parallel to the heating mode.

Please note that if you select DHW heating in parallel to heating mode, it will take longer to recharge the tank.

The factory setting is:

For DHW priority: "ON"



USER NOTE

For heating circuit 01 the DHW priority is always ON and cannot be disabled.

Changing the DHW priority

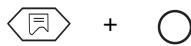

Press the "Display" key and "Install" key at the same time to call up the service level. "AMERICAN" appears as the first main menu.



Turn the dial until "CIRCUIT 02" is displayed.



Press "Display" to call up a submenu. "PERIM HTG" or "FLOOR HTG" appears.



Turn the dial until "DHW PRIOR" is shown.

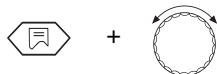
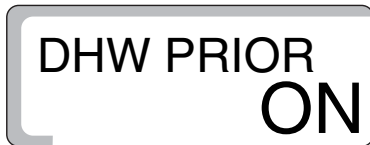

Hold down the "Display" key and turn the dial until the required value appears (in this case "OFF").



Release "Display" to store your input.



Press "ENTER" to return to the next higher level.

	Input range	Factory setting
DHW priority	ON OFF	ON

8.4 Maximum heating circuit temperature

The maximum heating circuit temperature is a target temperature that should not be exceeded in the heating circuit.

The factory setting is:

With PERIM HTG system: 194°F (90°C)
With FLOOR HTG system: 122°F (50°C)

This setting is only available for heating circuit 2.

Changing the maximum heating circuit temperature

Press the "Display" key and "Install" key at the same time to call up the service level. "AMERICAN" appears as the first main menu.

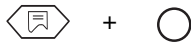

Turn the dial until "HEAT CIRC 2" is displayed.



Press "Display" to call up a submenu. "PERIM HTG" or "FLOOR HTG" appears.



Turn the dial until "MAX TEMP" is shown.

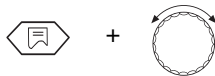
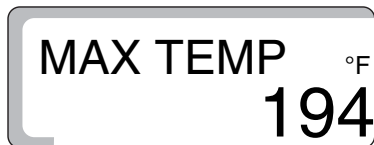

Hold down the "Display" key and turn the dial until the required value appears (in this case 140°F).



Release "Display" to store your input.



Press "ENTER" to return to the next higher level.

	Input range	Factory setting
Maximum heating circuit temperature for PERIM HTG	68 – 194°F (20°C – 90°C)	194°F (90°C)
Maximum heating circuit temperature for FLOOR HTG *)	68 – 140°F (20°C – 60°C)	122°F (50°C)

*) This function does not replace the safety thermostat for switching of the pump for radiant heating circuit.

8.5 Remote control ON/OFF

A BFU (accessory) remote control allows to easily control a heating system from the living space.

If the controller is equipped with a BFU remote control, the remote control must be activated and assigned to the appropriate heating circuit.

Instructions for assigning the remote control to the required heating circuit (HK1 or HK2) can be found in the remote control operating instructions.

The factory setting is:

For remote control: "OFF"



USER NOTE

Faulty communication is indicated by the LEDs flashing on the remote control.

Activating the remote control

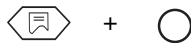

Press the "Display" key and "Install" key at the same time to call up the service level. "AMERICAN" appears as the first main menu.



Turn the dial until "HEAT CIRC 1" or "HEAT CIRC 2" is displayed.



Press "Display" to call up a submenu. "RADIATOR" or "UND-FLOOR" appears.



Turn the dial until "REMOTE 1" for heating circuit 1 or "REMOTE 2" for heating circuit 2 is displayed.

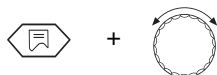

Hold down the "Display" key and turn the dial until the required value appears (in this case "ON").

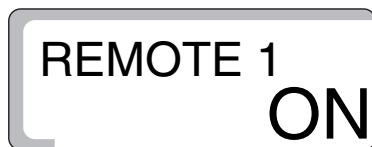

Release "Display" to store your input.



Press "ENTER" to return to the next higher level.

Further information on this can be found on the next page.

If the remote control is active, the desired room temperature for day and night mode must be entered on the remote control, rather than via the controls.



The "AUT", "Day mode" and "Night mode" keys on the controls also are disabled for this heating circuit with remote control.



If you press the "Temp", "AUT", "Day mode" or "Night mode" key, "REMOTE" appears on the display if the remote control is active.

All settings can then only be made via the remote control.

	Input range	Factory setting
Remote control	OFF ON	OFF

8.6 Maximum room temperature compensation

The room temperature compensation adjusts the calculated outdoor reset heating curve according to the measured room temperature. Any deviations from the room setpoint are then corrected immediately by adjusting the boiler setpoint temperature accordingly.



USER NOTE

The maximum room temperature hook-up determines the range within which deviations from the room setpoint value may be corrected. Influencing factors such as open windows or additional heat sources, e.g. wood burning stove, open fireplace, are thus eliminated in the area where the remote control is installed. If other rooms are supplied with heat via this heating circuit, then the aforementioned influencing factors can cause these near-by rooms to be supplied with insufficient heat. The function should be set to "OFF" to eliminate the chance of insufficient supply.

The maximum differential temperature can only be entered if the remote control has been activated. The influence of the room temperature on the DHW temperature (heating curve) is thus limited.



USER NOTE

If you entered "OFF", the room temperature no longer has any influence on the supply temperature (heating curve). This setting is generally recommended for FLOOR HTG systems.

The factory setting is:

With FLOOR HTG system: 6°F (3°C)

Further information on this can be found on the next page.

Changing the differential temperature



+



Press the "Display" key and "Install" key at the same time to call up the service level. "AMERICAN" appears as the first main menu.



Turn the dial until "CIRCUIT 01" or "CIRCUIT 02" is displayed.



Press "Display" to call up a submenu. "PERIM HTG" or "FLOOR HTG" appears.



Turn the dial until "ROOM COMP" is shown.

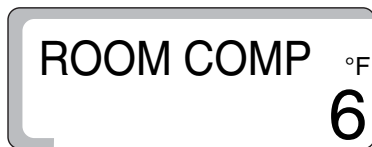

+



Hold down the "Display" key and turn the dial until the desired value appears (in this case "OFF").



Release "Display" to store your input.



Press "ENTER" to return to the next higher level.

	Input range	Factory setting
Differential temperature	OFF 2 – 18°F (1°C – 10°C)	6°F (3°C)

8.7 Setback mode selection

The Logamatic 2107 control contains night setback capability and allows you to select from 4 different types or modes of night setback for customized operation. These setback modes differ in their operation.

Night Setback Options

BLR OFF

1 Boiler Off ("BLR OFF")

In this mode the heating system shuts down completely during the night time as long as the outdoor temperature exceeds the "FREEZTEMP" setting. Below the "FREEZTEMP" value, the circulators run in freeze protection mode. The boiler only fires if the water temperature drops below 41°F (5°C). No room sensors are used in this setback mode.

SETBACK

2 General Setback ("SETBACK")

The heating circulators continue operation in the "SETBACK" mode; the boiler operates on a lower heating curve and fires the burner as needed. This mode is generally used when no room sensors are present and individual zones are controlled by conventional thermostats.

RMSETBACK

3 Room Setback ("RMSETBACK")

This setback mode should only be selected when a room sensor is installed and activated. The system operates to maintain the desired night time temperature as specified on the room sensor. The circulators will operate continuously when the outdoor temperature is below the "FREEZTEMP" setting; the circulators shut down when the outdoor temperature is above the "FREEZTEMP" setting and the actual room temperature exceeds the night time setting.

OASETBACK

4 Outdoor Air Setback ("OASETBACK"), factory default

The heating system (burner and heating circulators) shuts down in night mode if the outdoor temperature exceeds the "FREEZTEMP"; if the outdoor temperature drops below the "FREEZTEMP", the heating system operates on a setback curve. This mode should only be used on buildings not occupied in the night mode; i.e. commercial and daytime use only buildings. A room sensor is generally not used in this application.

Recommended setting

Heating circuit with constant circulation zone:

RMSETBACK (Requires room sensor)

Heating circuit with ONIOFF thermostats:

SETBACK (No room sensor present)

Commercial (day use only) buildings:

OASETBACK

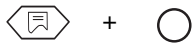

Press the "Display" key and "Install" key at the same time to call up the service level. "AMERICAN" appears as the first main menu.



Turn the dial until "CIRCUIT 01" or "CIRCUIT 02" is displayed.



Press "Display" to call up a submenu. "PERIM HTG" or "FLOOR HTG" appears.



Turn the dial until "OASETBACK" is displayed.

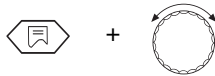
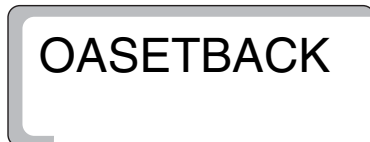

Hold down the "Display" key and turn the dial until the required value appears (in this case "OASETBACK").

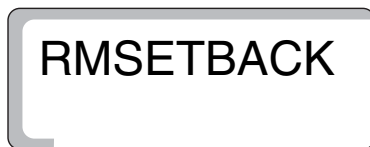

Release "Display" to store your input.



Press "ENTER" to return to the next higher level.

	Input range	Factory setting
Type of setback	Outdoor setback Room setback Setback Boiler off	Outdoor setback

8.8 Room temperature offset

If no remote control is installed in the living area, the room temperature compensation (see Chapter 8.6 "Maximum room temperature compensation" page 39) cannot be used. The room temperature values set on the controls then simply provide a specification for calculating the boiler setpoint temperature.

If the room temperature shown on the display differs from the room temperature measured with a thermometer mounted nearby, the values can be adjusted using "OFFSET".

Do not take the measurements while the system is heating up, e.g. after the night setback, but only after it had time to stabilize for several hours.

The adjustment causes a parallel shift in the heating curve.

The factory setting is:

Offset: 0°F (0°C)

for example:	Displayed room temperature	72°F (22°C)
	Measured room temperature	75°F (24°C)
	Offset	-3°F (-2°C)

Matching temperature values

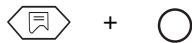

Press the "Display" key and "Install" key at the same time to call up the service level. "AMERICAN" appears as the first main menu.



Turn the dial until "CIRCUIT 01" or "CIRCUIT 02" is displayed.



Press "Display" to call up a submenu. "PERIM HTG" or "FLOOR HTG" appears.



Turn the dial until "OFFSET" is shown.

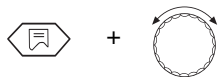
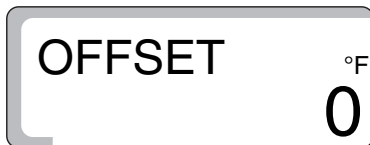

Hold down the "Display" key and turn the dial until the required value appears (in this case "-3°F").

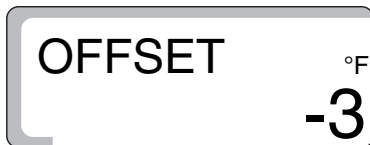

Release "Display" to store your input.



Press "ENTER" to return to the next higher level.

	Input range	Factory setting
OFFSET	-9 – +9°F (-5°C – +5°C)	0°F (0°C)

9 Solar data

9.1 Solar function ON/OFF (with FM 244 only)

The Solar function menu option is used to optimize the solar gain and minimize the use of fossil fuel.

To achieve this, the controllers for the solar heating system and the conventional heating boiler are combined in a single unit. The controls monitors the current solar gain and the stored heat in the DHW tank, and reduces the setpoint temperature in the standby part of the DHW tank to prevent it being reheated unnecessarily.

Switching off the solar function

Press the "Display" key and "Install" key at the same time to call up the service level. "AMERICAN" appears as the first main menu.

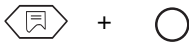

Turn the dial until the "SOLAR" main menu appears.



Press "Display" to call up a submenu. "SOLAR ON" appears.

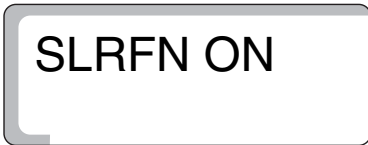

Hold down the "Display" key and turn the dial until the required value appears (in this case "SLRFN OFF").

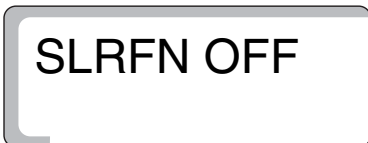

Release "Display" to store your input.



Press "ENTER" to return to the next higher level.

	Input range	Factory setting
SOLAR	ON OFF	ON

9.2 Maximum storage tank temperature in solar mode

The solar heating system will collect all solar heat that can be harvested. It will only stop when there is not sufficient insolation or to protect the tank from overheating. When "MAX SOL T" is reached at the top tank sensor FB, the solar pump is switched off.



WARNING!

RISK OF SCALDING

The DHW temperature can be set to a maximum of 194°F (90°C). At DHW temperatures over 122°F (50°C) there is a risk of scalding at the taps if no thermostatic mixing valve (anti-scald device) has been installed.

- If the DHW temperature is set above 122°F (50°C), you should only draw off mixed hot and cold water.

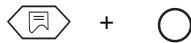

Press the "Display" key and "Install" key at the same time to call up the service level. "AMERICAN" appears as the first main menu.



Turn the dial until the "SOLAR" main menu appears.



Press "Display" to call up a submenu. "SOLAR ON" appears.



Turn the dial until "MAX-SL SR" appears.

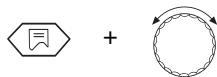
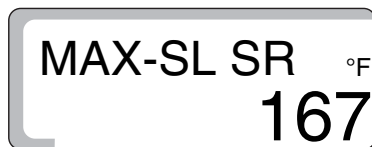

Hold down the "Display" key and turn the dial until the required value appears (in this case "194°F").

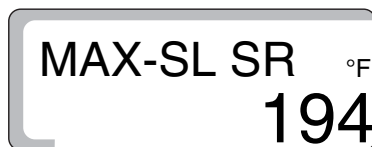

Release "Display" to store your input.



Press "ENTER" to return to the next higher level.



USER NOTE

Take the lime content of the local drinking water into consideration when determining the "MAX-SL SR" setting in order to prevent the tank scaling up.

	Input range	Factory setting
Max sol T	140 – 194°F (60°C – 90°C)	167°F (75°C)

9.3 Minimum storage tank temperature in solar mode

The DHW temperature to be generated by the boiler for a given solar gain (DHW setpoint, see operating instructions for the settings) may be automatically reduced so that the tank can be charged the solar heating system. The "MIN SOL T" parameter contains the lower limit to which the temperature may fall. If the temperature of the DHW in the tank (FB sensor) falls below the value set here, then it is recharged by the boiler. The DHW setpoint temperature to be generated by the boiler is lowered no further than "MIN SL SR".

The lowering function is deactivated in the "OFF" position (factory default).

Press the "Display" key and "Install" key at the same time to call up the service level. "AMERICAN" appears as the first main menu.

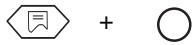

Turn the dial until the "SOLAR" main menu appears.



Press "Display" to call up a submenu. "SLRFN ON" appears.



Turn the dial until "MIN SL SR" appears.

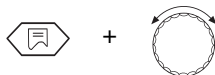
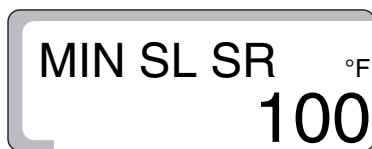

Hold down the "Display" key and turn the dial until the required value appears (in this case "130°F").

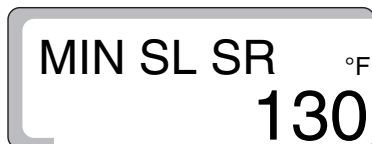

Release "Display" to store your input.



Press "ENTER" to return to the next higher level.

	Input range	Factory setting
MIN SL SR	86 – 130°F (30°C – 54°C) OFF	OFF

10 DHW production ON/OFF

If the heating system is equipped with a DHW tank, DHW heating must be activated. The factory setting is "ON".

If no DHW heating is installed, it should be disabled to avoid the DHW SENSERR error message.

The controls starts the burner if necessary in order to heat the DWH. The DHW tank charging pump runs. Once the burner has been switched off, the controls uses the residual heat in the boiler to heat the DHW.

Once the set DHW temperature is reached, the DHW tank charging pump is switched off. Normal heating mode is resumed at the end of the DHW heating cycle.

A recirculation pump (if installed) may be controlled if the DHW heating is activated.

Switching off the DHW heating

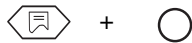

Press the "Display" key and "Install" key at the same time to call up the service level. "AMERICAN" appears as the first main menu.



Turn the dial until "DHW PROD" is shown.

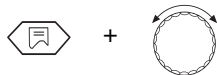
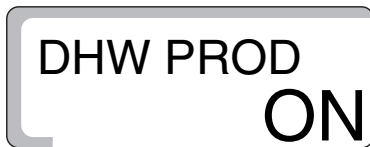

Hold down the "Display" key and turn the dial until the required value appears (in this case "OFF").



Release "Display" to store your input.



Press "ENTER" to return to the next higher level.

	Input range	Factory setting
DHW production	OFF ON	ON

11 DHW recirculation pump

The DHW recirculation pump ensures a constant supply of hot water to the taps. It is automatically activated with DHW heating and the pump runs in intermittent or continuous mode if at least one heating circuit is in normal heating mode (day mode), or if DHW heating is in day mode.

The DHW recirculation pump runs continuously in the "ON" position.

The factory default is "2", i.e. 2 pump runs per hour, running for 3 minutes each time (Fig. 10).

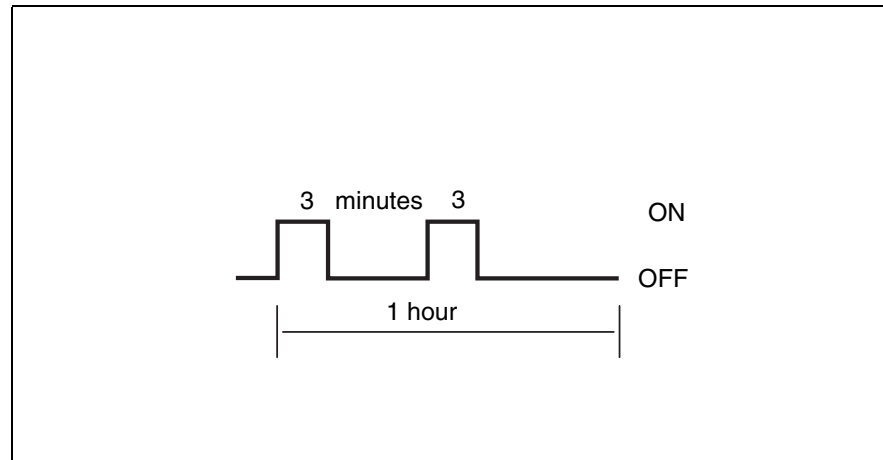
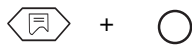

Fig. 10 Illustration of the DHW recirculation pump running time with factory setting 2

The intermittent mode may be set to 1 to 6 pump starts per hour in order to minimize the operating costs of the recirculation pump. This setting saves energy while ensuring comfort.

Changing the recirculation pump run time



Press the "Display" key and "Install" key at the same time to call up the service level. "AMERICAN" appears as the first main menu.



Turn the dial until the "RECIRCPUMP 2" main menu is displayed.

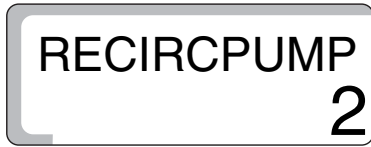

Hold down the "Display" key and turn the dial anti-clockwise until the required value appears (in this case "4").

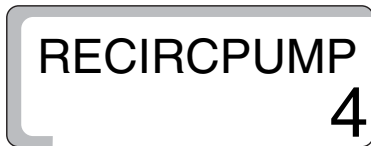

Release "Display" to store your input.



Press "ENTER" to return to the next higher level.

	Input range	Factory setting
DHW recirculation pump	OFF 1 2 3 4 5 6 ON	2

12 Heating curve

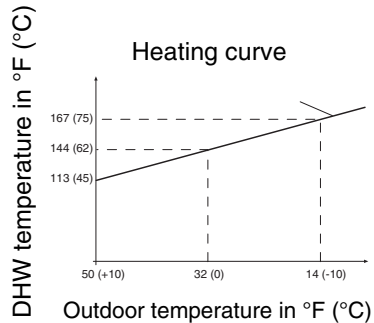

Fig. 11 Heating curve test

The heating curve test is used to display the DHW temperature for the current operating status at external temperatures 50°F (+10°C), 32°F (±0°C) and 14°F (-10°C).

The heating curve displayed here (Fig. 11) is calculated by the controls on the basis of the values set for design temperature, offset and setpoint room temperature, and corresponds to the currently active characteristic. To ensure that there is no shift during commissioning, ensure during commissioning that:

the heating circuit is in "day mode"
(press the "Day" key),

the heating circuit is in "automatic mode"
("WWSD" key).

The heating curve changes when room temperature hook-up is activated.

Displaying the heating curve

Press the "Display" key and "Install" key at the same time to call up the service level. "AMERICAN" appears as the first main menu.

Turn the dial until "HTG CURVE 01" for heating circuit 1 or "HTG CURVE 2" for heating circuit 2 (mixed circuit) is displayed.

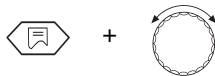
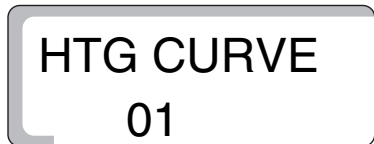
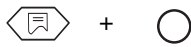

Hold down "Display" and turn the dial. The first display contains the DHW temperature at 50°F (+10°C), the second at 32°F (±0°C) and the third at 14°F (-10°C).

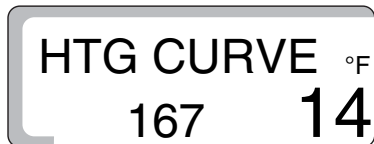
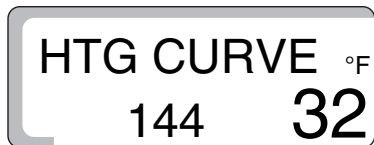
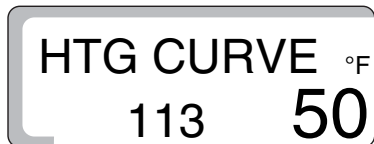

Release the "Display" key to return to the next higher level.

13 Running the relay test

The relay test is used to check that the switching relays in the controls are working correctly.



SYSTEM DAMAGE

due to controller functions being deactivated for the duration of the relay test. The heat supply to the system is not guaranteed, so it is essential to press the "ENTER" key at the end of the relay test to exit the relay test function and thus avoid damaging the system.

The displays differ according to which modules are installed in the controls. The following relays can be called up:

- Burner 1st stage / 2nd stage
- Modulation open/closed OFF
- Boiler system pump HK1
- Heating circuit pump HK 2
- Mix valve open/closed/OFF
- Tank DHW pump
- DHW recirculation pump
- Solar pump

Steps of the relay test

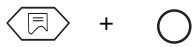

Press the "Display" key and "Install" key at the same time to call up the service level. "AMERICAN" appears as the first main menu.



Turn the dial until "RELAY" is shown.



Press "Display" to call up a submenu. "BURNER" appears.

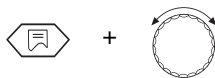

Hold down the "Display" key and turn the dial, until "BURNER ON" appears in the display.

Release the "Display" key.

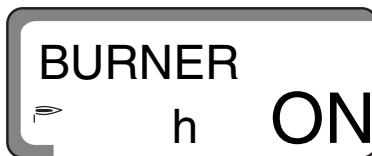

The burner starts up.

If the burner is working correctly and the operating hours signal has been returned by the burner, an "h" appears in the display.

Turn the dial to display all the relay functions in succession.



Press "ENTER" to return to the next higher level.



The relay switching states are represented by symbols, e.g. for the recirculation pump (left, 1st symbol) or for DHW tank filling pump / solar pump (right, 2nd symbol).



USER NOTE

The pump symbol lights up continuously if the DHW tank filling pump is running. If the solar pump and DHW tank filling pump are running, then the solar pump symbol flashes.

Safety instructions

All available relays can be manually activated and deactivated in the relay test. With the solar pump it should be noted that a safety override may prevent activation if there is a risk of damage to the system (collector, DHW tank). Specifically this means that it will not be switched on if:

- the solar module is defective
- a defective collector (FSK) or DHW heating sensor (FB) was detected
- the collector temperature has reached the maximum permitted temperature
- the tank temperature has reached the maximum permitted temperature



Press "ENTER" to return to the next higher level.

14 Performing an LCD test

The LCD test is used to check whether all the figures and symbols are displayed in full.

Carrying out an LCD test

Press the "Display" key and "Install" key at the same time to call up the service level. "AMERICAN" appears as the first main menu.

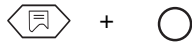

Turn the dial until "LCD TEST" is shown.

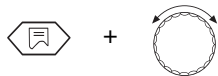
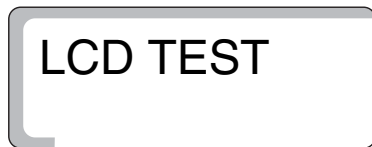

Hold down "Display" and turn the dial. All the numbers and symbols must appear on the display.

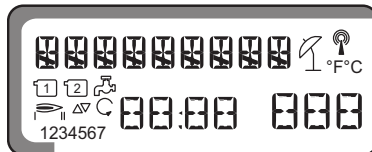

Release the "Display" key.



Press "ENTER" to return to the next higher level.

15 Time, correcting the accuracy

Here you can set the time accurately to the second.

The factory setting is "0" seconds/day.

Define the deviation in seconds/day.

Press the "Display" key and "Install" key at the same time to call up the service level. "AMERICAN" appears as the first main menu.

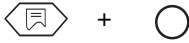

Turn the dial until "TIME" is shown.



Hold down "Display" and turn the dial until the identified deviation appears in the display, e.g.: if it is 10 s/day fast, then set to -10 s/day.



Release "ENTER" to store your input.



Press the "Display" key to return to the next higher level.

	Input range	Factory setting
Time	-30 seconds/day – +30 seconds/day	0

16 Reset

"RESET" is used to return all the controls settings to their factory settings. Any previously programmed heating times as well as burner and solar hours remain unchanged, however.

Reset steps

Press the "Display" key and "Install" key at the same time to call up the service level. "AMERICAN" appears as the first main menu.

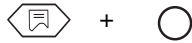

Turn the dial until "RESET" and 7 eights are displayed.

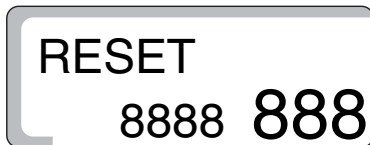

Hold down the "Display" key until all the numbers in the display have disappeared.



Release the "Display" key.

The preset factory settings are now restored.
The numbers appear in the display once more.

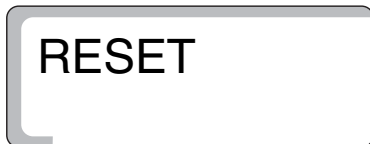

No "RESET" is carried out if you release the "Display" key before all the numbers have disappeared.



Press "ENTER" to return to the next higher level.

17 Version number

The version number is an encoded number that represents the production release of the controls.

The version number must be specified in the event of troubleshooting or questions about upgrades to the controls.

Displaying the version number

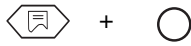

Press the "Display" key and "Install" key at the same time to call up the service level. "AMERICAN" appears as the first main menu.



Turn the dial until "VERSION" and the version number (in this case "3.24") are displayed.

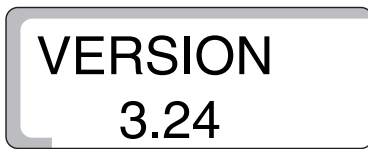

18 Sensor curves



RISK OF LIFE

from electric shock.

WARNING!

- Disconnect the system from the power supply before opening the cover of the controls.

- Remove the plug for the sensor to be measured from the controls (FB, FA, FK, FV, FG, FSK, FSS).

Measure the resistance at the connector terminals.

Always take the comparative temperature measurement (room, supply, external and flue gas temperatures) in the vicinity of the sensor.

The curves depict mean values and are subject to tolerances.

Outdoor temperature sensor (FA)

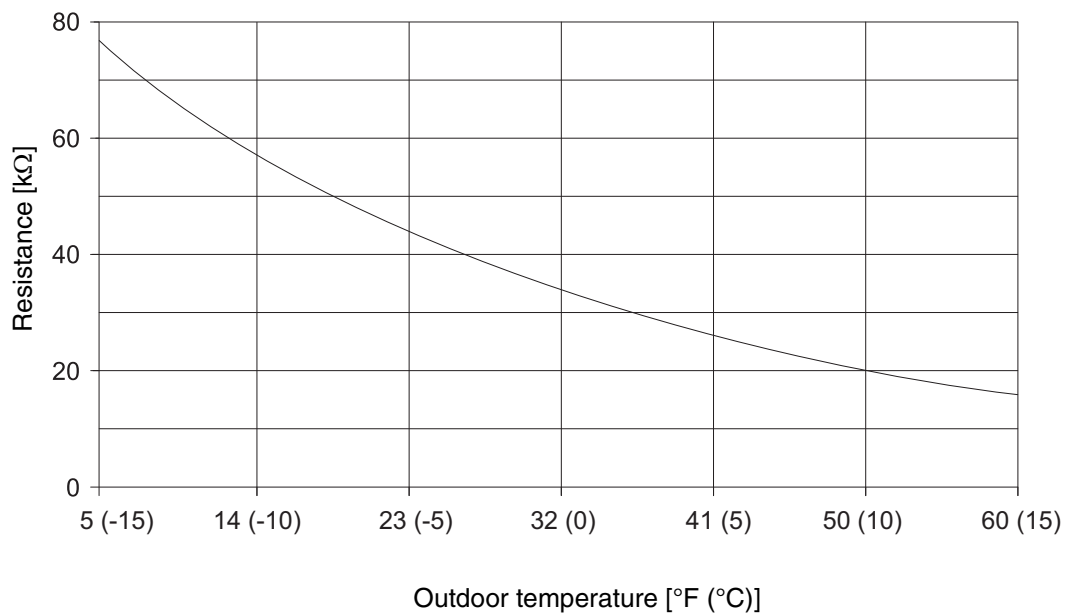

Boiler water (FK), supply (FV), DHW (FB) and solar water tank (FSS) temperature sensors

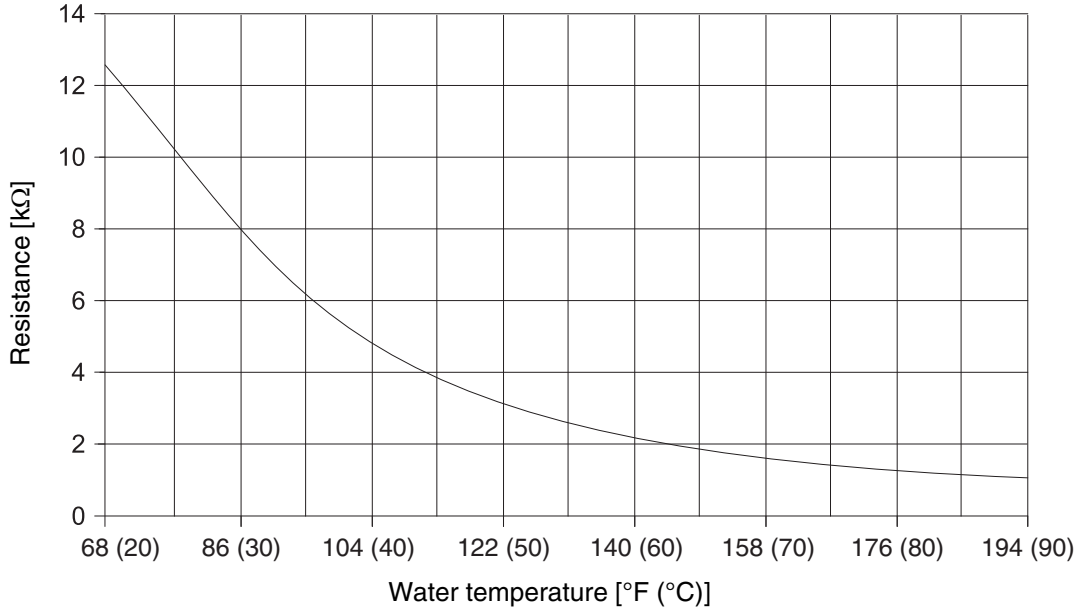

Collector sensor (FSK)

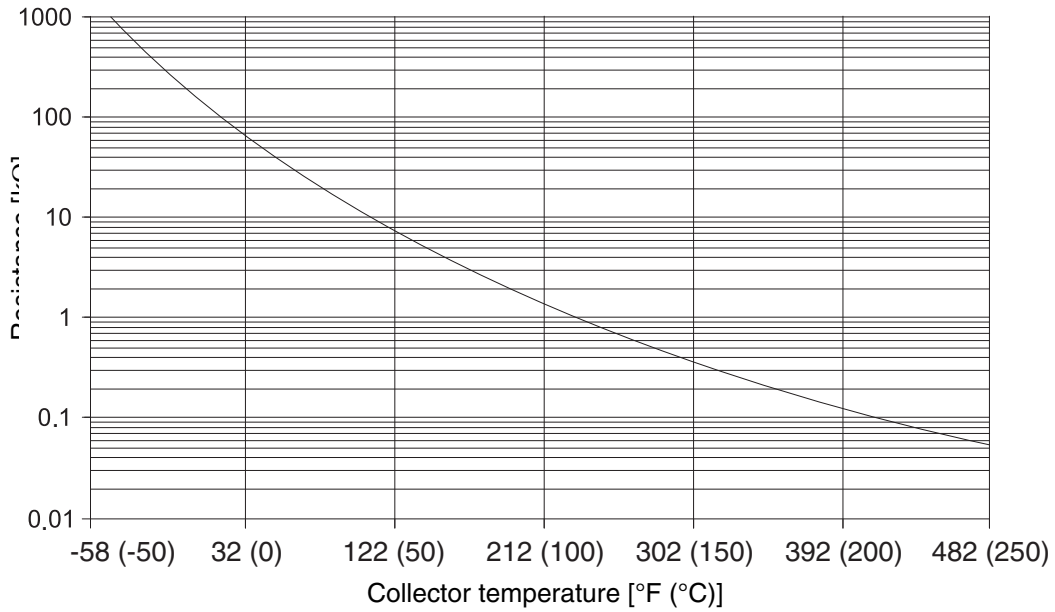

19 Operating values at the service level/setup report

	Input range	Factory setting	Setting
Language	American	American	
Building response	-4 – 50°F (-20°C – 10°C)	41°F (5°C)	
Type of construction	1, 2, 3	2	
Burner system	1-stage/2-stage/modulating	1-stage	
Modulating output	10 %–60 %	30 %	
Operating time of the burner actuator	5 s–60 s	12 s	
Pump logic	59 – 140°F (15°C – 60°C)	104°F (40°C)	
Maximum temperature	158 – 210°F (70°C – 99°C)	176°F (80°C)	
Heating circuit 01	None/PERIM HTG	PERIM HTG	
Heating circuit 02	None/PERIM HTG/FLOOR HTG	FLOOR HTG	
Reference temperature (PERIM HTG 1 or 2)	86 – 194°F (30 °C – 90°C)	167°F (75°C)	
Reference temperature (FLOOR HTG 2 only)	86 – 140°F (30°C – 60°C)	113°F (45°C)	
Remote control for heating circuit 1	OFF/ON	OFF	
Remote control for heating circuit 2	OFF/ON	OFF	
Offset circuit 1	OFF/2 – 18°F (1 – 10°C)	6°F (3°C)	
Offset circuit 2	OFF/2 – 18°F (1 – 10°C)	6°F (3°C)	
Setback type for heating circuit 1	Outdoor setback Room setback Setback Switch-off	Outdoor setback	
Setback type for heating circuit 2	Outdoor setback Room setback Setback Switch-off	Outdoor setback	

Further information on this can be found on the next page.

	Input range	Factory setting	Setting
Offset for heating circuit 1	-9 – +9°F (-5°C – +5°C)	0°F (0°C)	
Offset for heating circuit 2	-9 – +9°F (-5°C – +5°C)	0°F (0°C)	
DHW priority	ON/OFF	ON	
Maximum heating circuit temperature for heating circuit 2 (PERIM HTG)	68 – 140°F (20°C – 60°C)	PERIM HTG 194°F (90°C)	
Maximum heating circuit temperature for heating circuit 2 (FLOOR HTG)	68 – 194°F (20°C – 90°C)	FLOOR HTG 113°F (45°C)	
Solar function	ON/OFF	ON	
MAX-SL SR	140 – 194°F (60°C – 90°C)	167°F (75°C)	
MIN-SL SR	86 – 130°F (30°C – 54°C)/OFF	OFF	
DHW PROD	ON/OFF	ON	
DHW recirculation pump	OFF/1/2/3/4/5/6/ON	2	
Time	-30 seconds/day – +30 seconds/day	0 seconds/day	

20 Troubleshooting

Only one error is displayed at a time, so the following table indicates the priority of each error.

Fault	Possible cause of the fault	Effects on control characteristics	Remedy
Burner fault BURNER ERROR	Burner control	Boiler not working Central heating stays cold	Eliminate the burner fault as described in the boiler or burner documentation.
Boiler sensor error BLR SENSOR ERROR	Sensor defective. Connecting cable interrupted	The boiler is enabled with maximum output (emergency mode via thermostat is possible).	Check the sensor connection. Replace the sensor
Outdoor sensor error OA SENSOR ERROR	Sensor defective. Connecting cable interrupted	The minimum outdoor temperature is expected (outdoor temp.: 14°F (-10°C))	Check the sensor connection. Replace the sensor
DHW sensor error DHW SENSOR ERROR	Sensor defective. Connecting cable interrupted	DHW tank no longer being topped up Solar pump is switched off	Check the sensor connection. Replace the sensor
Collector sensor error SL SENSOR ERROR	Sensor defective. Connecting cable interrupted Solar module (FM 244) defective	Solar pump is switched off	Check the sensor connection. Replace the sensor Replace the module
Solar hot water sensor error DHW-SL ERROR	Sensor defective. Connecting cable interrupted Solar module (FM 244) defective	Solar pump is switched off	Check the sensor connection. Replace the sensor Replace the module
Heating error HEATING ERROR	Boiler water thermostat set too low. Manual reset high limit (STB) tripped No fuel Sensor not arranged correctly	No boiler protection Boiler stays cold	Set boiler water thermostat to "AUT" Manual reset high limit (STB) Check the fuel Check the sensor position
DHW error DHW PROD ERROR	Sensor not mounted correctly Filling pump is connected incorrectly or defective.	Constant attempts are made to top up the DHW, but with a reduced boiler supply setpoint temperature.	Check sensor and pump Manual mode
Remote control 1 error REMOTE1 ERROR	Remote control has wrong address Incorrect wiring Remote control is defective Connecting cable interrupted	There is no current room temperature measurement, so the ambient influence, switch-on and switch-off optimization and automatic adaptation do not apply.	Check the address Check the wiring Replace the remote control
Remote control 2 error REMOTE2 ERROR	Remote control has wrong address Incorrect wiring Remote control is defective Connecting cable interrupted	There is no current room temperature measurement available, so the ambient influence does not apply	Check the address Check the wiring Replace the remote control

Fault	Possible cause of the fault	Effects on control characteristics	Remedy
Supply temperature sensor 2 error MIX SENSOR ERROR	Sensor defective. Connecting cable interrupted	The mixer is no longer being controlled.	Check the sensor connection. Replace the sensor
FM 241 error (mixing card) FM 241 ERROR	Module no longer present Module defective	Module is no longer being addressed	Log the module off Plug the module in again Replace the module
FM 242 error (burner card) FM 242 ERROR	Module no longer present Module defective	Module is no longer being addressed	Log the module off Plug the module in again Replace the module
FM 244 error (solar card) FM 244 ERROR	Module no longer present Module defective	Module is no longer being addressed	Log the module off Plug the module in again Replace the module

20.1 Troubleshooting "NO HEAT" call

ZM1	Netz	Si-Geräte	Brenner	Abgasüberwachung	PH-HK1	PS	PWF
⚡ N L ⊗ ⊗ ⊗	⚡ N L ⊗ ⊗ ⊗	17 18 19 ⊗ ⊗ ⊗	⚡ 4 8 9 10 11 12 ⊗ ⊗ ⊗ ⊗ ⊗ ⊗	⚡ N 1 2 3 4 ⊗ ⊗ ⊗ ⊗ ⊗	⚡ 61 63 ⊗ ⊗ ⊗	⚡ 24 25 ⊗ ⊗ ⊗	⚡ 13 14 ⊗ ⊗ ⊗

“BRENNER” (burner) wiring block

- Terminal 4 – 120V Neutral
- Terminal 8 – 120V input clocks hours run meter (must be field wired)
- Terminal 9 – 120V input displays “BURNER ERR” message (must be field wired)
- Terminal 10 / 11 – “dry” contacts close to energize burner
- Terminal 12 – 120V power (drops out when manual reset limit is tripped)

Burner operation

The R2107 is not a cold start control. It does not reply on a call for heat from an end switch or thermostat to fire the boiler.

The boiler will maintain a range of water temperature based on outdoor temperature. The differential of this range is dynamic,

meaning that it is not fixed, and will adjust based on outdoor temperature and current system load. The starting point of the differential

is 27°F (15°C) and will adjust from there. The differential will generally be wider at milder outdoor temperatures and narrower at

colder outdoor temperatures. The differential is split above & below the current target temperature.

Example: Outdoor temperature at 32°F, based on heating curve the water temperature required is 140°F with a 26°F burner differential.

The differential (26°F) is split (13°F) above & (13°F) below the target temperature.

140°F target + 13°F = 153° high limit

140°F target - 13°F = 127° low limit

This 127°F to 153°F becomes the range of temperature that the boiler will maintain. As zones call and pull heat from the boiler, eventually the temperature in the boiler drops. Once the temperature in the boiler hits the low limit (127°F) the R2107 control closes a switch (dry contacts) between terminals 10 & 11 to fire the boiler (this is indicated by a flame symbol  displayed on the LDC screen of the R2107). When the boiler temperature reaches the high limit (153°F), the contacts open and the boiler stops firing.

Once the outdoor temperature drops below the WWSD setting, the boiler begins to maintain temperature. Above WWSD the boiler will only fire on a call for DHW.

ZM1	Netz	Si-Geräte	Brenner	Abgasüberwachung				PH-HK1	PS	PWF
⏏ N L ⊗ ⊗ ⊗	⏏ N L ⊗ ⊗ ⊗	17 18 19 ⊗ ⊗ ⊗	⏏ 4 8 9 10 11 12 ⊗ ⊗ ⊗ ⊗ ⊗ ⊗	⏏ N 1 ⊗ ⊗ ⊗	2 3 4 ⊗ ⊗ ⊗	⏏ 61 63 ⊗ ⊗ ⊗	⏏ 24 25 ⊗ ⊗ ⊗	⏏ 13 14 ⊗ ⊗ ⊗		

Oil burners – factory jumper between terminals 12 & 10, brings 120V from 12 to 10. When contacts close between terminals 10 & 11, 120V power is sent from terminal 11 to Hot on the burner (terminal 4 is the neutral).

Gas burners – remove factory installed jumper between terminals 10 & 12. The contacts between terminals 10 & 11 are now “dry” (no voltage present) and switching to the burner is now low voltage between terminals 10 & 11 on the R2107 and TT (or RW) on the boiler aquastat.

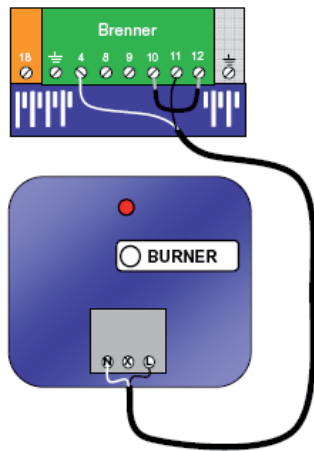

3rd Party Oil Burner

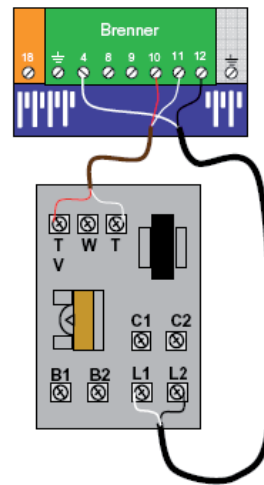

Gas Burner

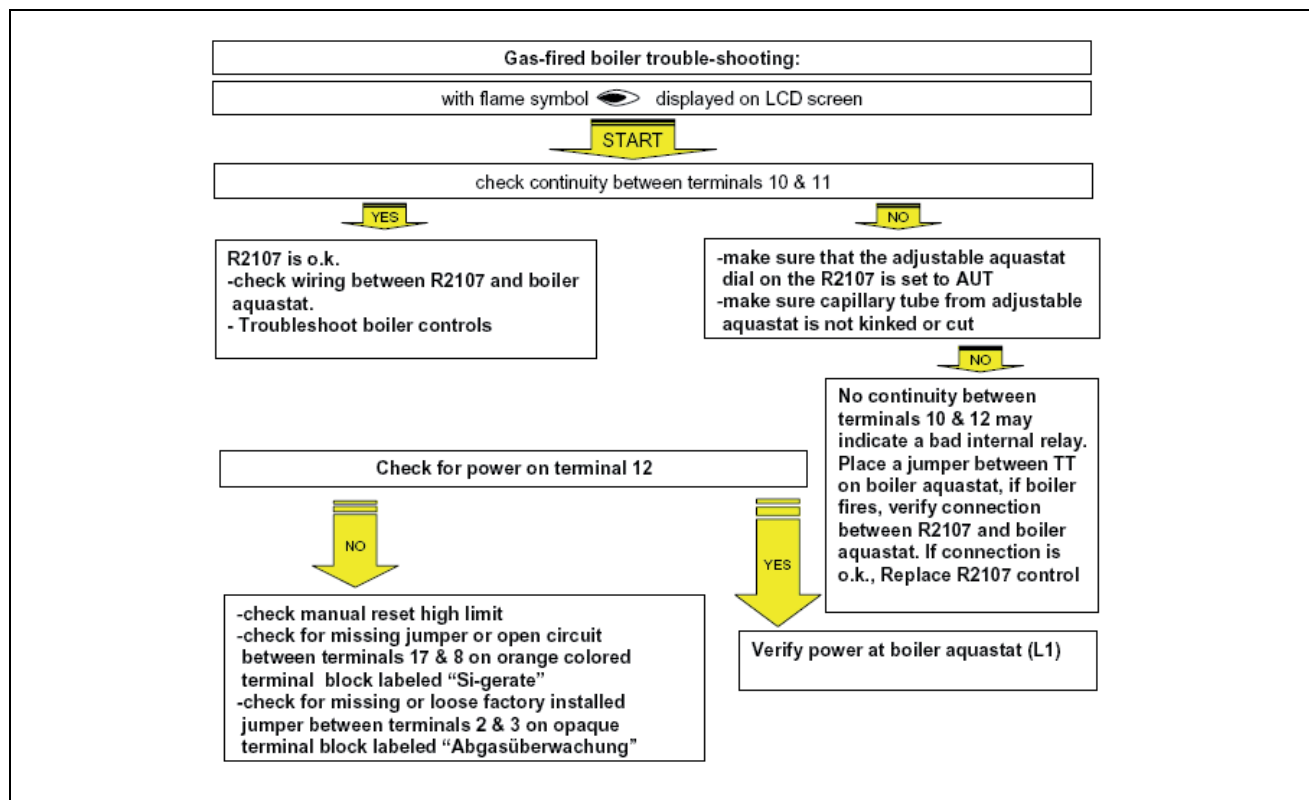
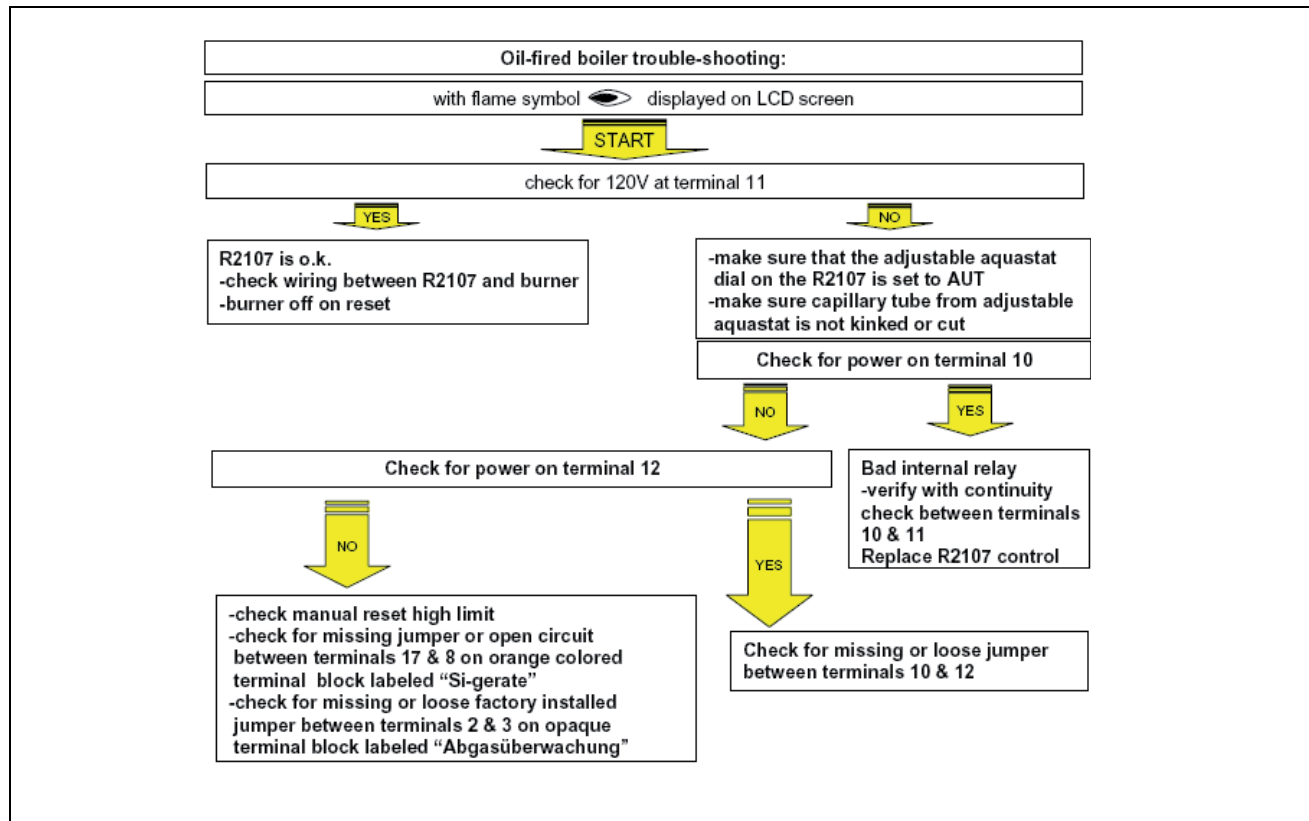

20.2 Troubleshooting „INSUFFICIENT HEAT“ call

A call for insufficient heat is generally a simple matter of adjusting the heating curve.

The water temperature required for any heating system is determined by any number of factors but the biggest influence we see is the amount of radiation in comparison to the actual heat loss. Buildings with less radiation in relation to their actual heat loss require higher water temperature than buildings that are over-radiated. Every house is unique in terms of its heat requirements. Some of the many factors include, construction, exposure to sun, elevation, surroundings (trees, other structures, etc), furnishings, internal heat gain (computers, lights, people, appliances, etc) and the expectations and comfort level of the individual.

The heating curve on a R2107 can be adjusted in several ways:

REF TEMP – the reference temperature adjusts the slope of the heating curve. The REF temperature in the R2107 references a boiler water temperature at 14°F outdoor temperature. In general, if the homeowner complains that they can never get the house up to temperature, adjust the REF temperature up. A rule of thumb would be: for every 1 degree you want to raise the room temperature, increase the REF temp by 2.5 degrees.

For example: Customer says they can't get the house above 65°F. We need to increase the room temperature by 5°F... $5 \times 2.5 = 12.5$.

You would increase the REF temperature by 12 or 13 degrees. The default setting in the R2107 is 167° REF temperature.

OFFSET – the OFFSET setting is used to raise the starting water temperature of the system. Another way to say this is, raising the OFFSET setting will give you higher water temperature at milder outdoor temperatures. Common applications for adjusting the OFFSET setting include, hydro-air, fan coils, unit heaters, etc. These types of heating units typically require some amount of minimum water temperature. Occasionally, you may have a call for insufficient heat but only in milder weather. Even with fin-tube radiation, cast-iron radiators or panel radiators. With this type of a call, you will want to increase the OFFSET setting.

USE THE QUICK REFERENCE GUIDE FOR INITIAL PROGRAMMING

20.3 Troubleshooting Domestic Hot Water

ZM1	Netz	Si-Geräte	Brenner	Abgasüberwachung	PH-HK1	PS	PWF
⊕ N L ⊗ ⊗ ⊗	⊕ N L ⊗ ⊗ ⊗	17 18 19 ⊗ ⊗ ⊗	⊕ 4 8 9 10 11 12 ⊗ ⊗ ⊗ ⊗ ⊗ ⊗	⊕ N 1 2 3 4 ⊗ ⊗ ⊗ ⊗ ⊗ ⊗	⊕ 61 63 ⊗ ⊗ ⊗	⊕ 24 25 ⊗ ⊗ ⊗	⊕ 13 14 ⊗ ⊗ ⊗

TROUBLESHOOTING A “NO DHW” CALL:

A “DHW PROD ERR” message will appear on the LCD screen of the R2107 control with regard to domestic hot water production.

DHW ERR - when the tank temperature drops to the low limit (9°F below the set point), the R2107 goes into DHW priority mode.

During DHW priority, the R2107 raises the boiler water temperature to its high limit, interrupts power to the space heating circuit {terminals 61(N) & 63 (H)} and energizes the DHW pump circuit {terminals 24 (N) & 25 (H)}. The pump circuit symbol  is displayed on the LCD screen.

In DHW priority, if the R2107 does not sense a rise in DHW temperature in 30 minutes, it will display a DHW PROD ERR message.

At this point, the control will go back to space heating mode and lock out the DHW to avoid freezing the building. This message is general in nature and the R2107 control is essentially telling you, “I tried to make domestic hot water but nothing happened”.

IN MOST CASES THE PROBLEM IS NOT WITH THE R2107 CONTROL. To rule out the R2107, turn power off to the R2107 to reset.

The R2107 will again try to make DHW. Check terminals 24 & 25 for 120V. If power is present and boiler fires the R2107 is o.k.

Check the following:

- 1 - bad circulator
- 2 - stuck flow check
- 3 - piping is air bound
- 4 - closed valve

21 Index

B

Boiler water temperature sensor58
Burner system24

C

Collector sensor58
Controls on the 210712

D

Design temperature33
DHW priority35
DHW recirculation pump48

E

Emergency shutoff switch – heating system	6
---	---

F

Frost protection	6
----------------------------	---

H

Heat storage capacity22
Heating circuit temperature36
Heating curve50
Heating system30

L

Language selection29
LCD test53

M

Manual reset high limit (STB)17
Maximum room temperature hook-up39
Menu18
Modulating output25

O

OFF temperature28
ON temperature27
Operating time of the burner actuator26
Outdoor temperature sensor57

P

Password17
Pump kick20
Pump logic27

R

Relay test51
Remote control37
Reset55
Room temperature offset43

S

Safety instructions	5
Sensor curves57
Service level17
Setting parameters19
Setup report59, 61
Solar function44
System frost protection, frost protection21

T

Type of construction22
Type of setback41

V

Version number56
--------------------------	-----

United States and Canada

Bosch Thermotechnology Corporation
50 Wentworth Avenue
Londonderry, NH 03053
U.S.A.
Tel. 603-552-1100
Fax 603-584-1681
www.buderus.net

Products manufactured by
Bosch Thermotechnik GmbH
D-35573 Wetzlar
www.buderus.de

Bosch Thermotechnology Corporation reserves the
right to make changes without notice due to continuing
engineering and technological advances.

Buderus