

Parts List



File No.

Air Conditioner

REFERENCE No.PL 706901

CONTENTS

	Model No.	Prod.Code	Volt-Phase-Hertz	Country of Origin	Page
OUTDOOR UNIT	CU-3KS19NBU	1 852 361 24	230-208-1-60	DSK	1
	CU-4KS24NBU	1 852 361 25	230-208-1-60	DSK	5
	CU-4KS31NBU	1 852 361 26	230-208-1-60	DSK	9
	CU-3KE19NBU	1 852 361 27	230-208-1-60	DSK	13
	CU-4KE24NBU	1 852 361 28	230-208-1-60	DSK	17
	CU-4KE31NBU	1 852 361 29	230-208-1-60	DSK	21
INDOOR UNIT	CS-MKS7NKU	1 852 360 94	230-208-1-60	SSA	25
	CS-MKS9NKU	1 852 360 95	230-208-1-60	SSA	28
	CS-MKS12NKU	1 852 360 96	230-208-1-60	SSA	31
	CS-MKS18NKU	1 852 360 97	230-208-1-60	SSA	34
	CS-MKS24NKU	1 852 360 98	230-208-1-60	SSA	37
	CS-MKE7NKU	1 852 360 99	230-208-1-60	SSA	40
	CS-MKE9NKU	1 852 361 00	230-208-1-60	SSA	43
	CS-MKE12NKU	1 852 361 01	230-208-1-60	SSA	46
	CS-MKE18NKU	1 852 361 02	230-208-1-60	SSA	49
	CS-MKE24NKU	1 852 361 03	230-208-1-60	SSA	52

CU-3KS19NBU
OUTDOOR UNIT

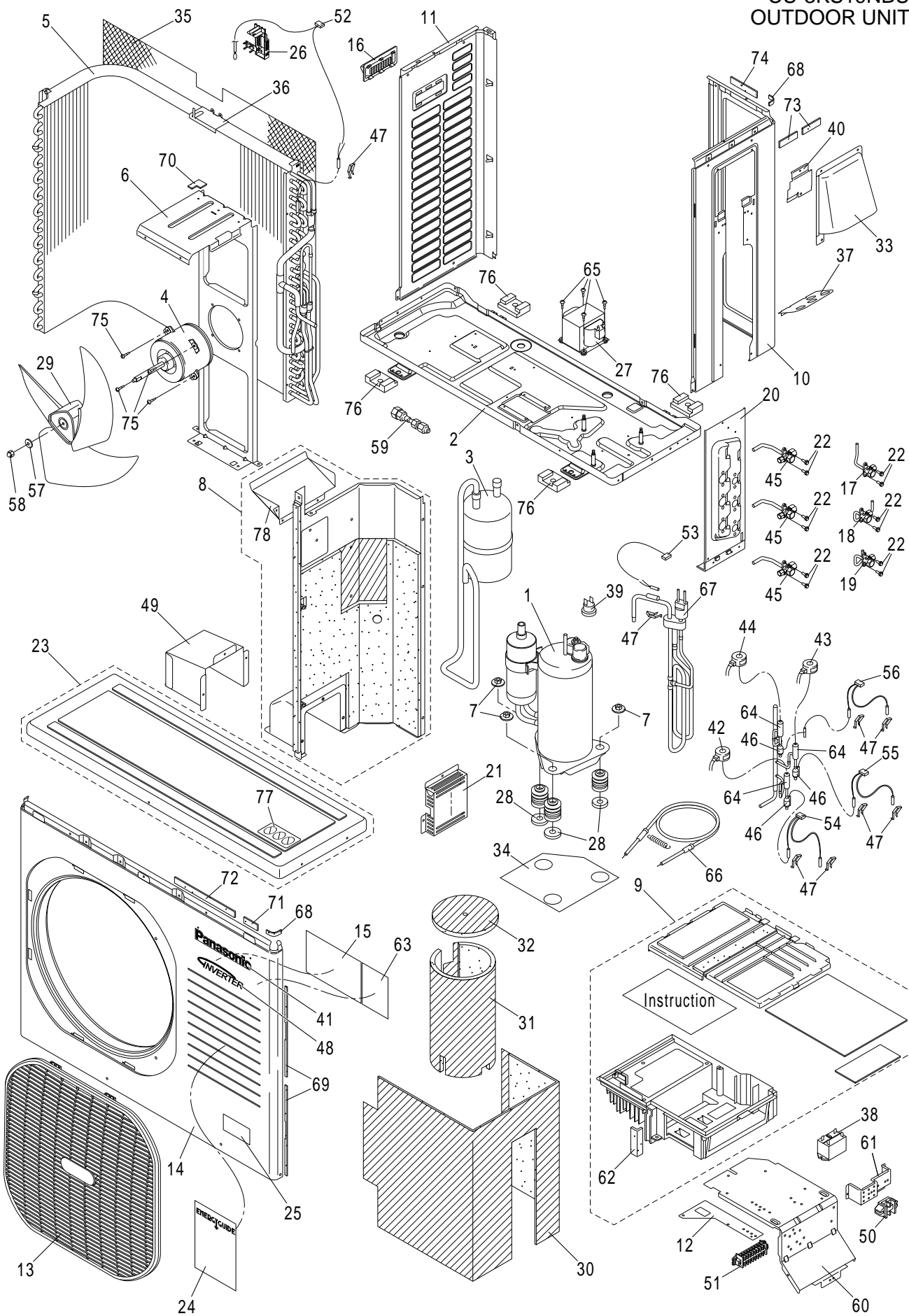

ATTENTION!

To ensure correct parts supply, please let us know the following,

Part No. when you make service parts order:

1.Part No. 2.Description 3.Q'ty 4.Volts-Hz-Ph 5.Product Mode No.

CU-3KS19NBU
OUTDOOR UNIT

KeyNo.	Part No.	Description	Model Number	Q'ty	Reference No.
* 1	CV6231924016	Comp Sub Ass'y	5KD240XAB21	1	8520452634100
2	CV6233136233	Bottom Plate Ass'y		1	8520220280002
3	CV6231924009	Accumulator Ass'y		1	8520451131400
* 4	CV6231915427	Fan Motor	SIC-71FW-D490-1	1	1FA4M4A010400
5	CV6231931830	Heat Exch Cond Ass'y		1	8520411920300
6	CV6231915403	Mounting Plate, Fan Motor		1	8522235431400
7	CV6231938068	Nut Special		3	8522222615501
8	CV6233188843	Partition Plate Ass'y		1	8520220953000
* 9	CV6233188935	Controller Assy(Including PCB)	CB-CU-3KS19NBU-SRV	1	8549953605962
10	CV6233136264	Side Panel		1	8522111442301
11	CV6233136257	Side Panel		1	8522111441302
12	CV6231947459	Mounting Plate		1	8522238518701
13	CV6231917858	Guard		1	8522132124211
14	CV6233136240	Front Panel		1	8522111824702
15	CV6233188928	Elec. Wiring Diagram		1	8FA2525111800
16	CV6231917186	Handle		1	8522230317811
17	CV6231924092	Valve Ass'y 1/4"		1	8520451544000
18	CV6231924085	Valve Ass'y 1/4"		1	8520451544100
19	CV6231924078	Valve Ass'y 1/4"		1	8520451544200
20	CV6233136288	Support Valve		1	8522222238701
21	CV6231917421	Cover Plate		1	8522531549101
22	CV6233147437	S Tite Screw		12	3920461601
23	CV6233188881	Top Plate Ass'y		1	8520110326200
24	CV6233188942	Ftc Tag		1	8526445925200
25	CV6231611497	Label		1	8542135895900
26	CV6231719278	Mounting Thermostat		1	8522530324501
* 27	CV6231917902	Reactor	R9020A-TE-COV	1	1FA4L5C013500
28	CV6231915618	Cushion Rubber		3	8522239030800
* 29	CV6233043500	Propeller Fan Ass'y		1	8520250218900
30	CV6231924115	Insulation		1	8522247669300
31	CV6231924108	Insulation		1	8522247671900
32	CV6231915632	Insulation		1	8522247672000
33	CV6233136318	Cover Ass'y		1	8520230925120
34	CV6231915526	Sheet		1	8522532850000
35	CV6231917926	Guard		1	8522132124700
36	CV6231915540	Mounting Plate		1	8522238515801
37	CV6233136301	Conduit Plate		1	8522131945121
* 38	CV6231727730	Power Relay	EL200/240A1-F(M)	1	1FA4S2A010000
* 39	CV6233106328	Thermistor Ass'y	CS-7L-2515	1	8FA0515500700
40	CV6233136295	Mounting Plate		1	8522238517802

NOTE: Metal and plastic parts will be supplied basically with necessary heat insulation pads or packing. Each key number with an asterisk (*) means the recommended service parts.

ATTENTION!

To ensure correct parts supply, please let us know the following,

Part No. when you make service parts order:

1.Part No. 2.Description 3.Q'ty 4.Volts-Hz-Ph 5.Product Mode No.

CU-3KS19NBU
OUTDOOR UNIT

KeyNo.	Part No.	Description	Model Number	Q'ty	Reference No.	
41	CV6233172071	Badge		1	8542135433401	
*	42	CV6231924184	Magnetic Coil	UKV-A014 5P A-MV	1	8FA0525115200
*	43	CV6231924177	Magnetic Coil	UKV-A006 5P B-MV	1	8FA0525115300
*	44	CV6231924160	Magnetic Coil	UKV-A007 5P C-MV	1	8FA0525115400
	45	CV6231955447	Valve Ass'y 3/8"		3	8520451827200
	46	CV6231552424	Strainer Ass'y		3	8520450619500
	47	CV6231485876	Mounting Thermostat		8	8522530322401
	48	CV6233174174	Badge		1	8542135433301
	49	CV6233188904	Cover		1	8522251535501
*	50	CV6233188898	Terminal Base	JTU30-2U-SA0588	1	1FA4J3A048800
*	51	CV6231931908	Terminal Base	KTU15N-9J	1	1FA4J3A026500
*	52	CV6231924245	Thermistor Ass'y K	TKS292B/295B	1	8FA0525916700
*	53	CV6231924238	Thermistor Ass'y K	TKS293B	1	8FA0525916900
*	54	CV6231924221	Thermistor Ass'y K	TKS292B/292B	1	8FA0525917400
*	55	CV6231924214	Thermistor Ass'y K	TKS292B/292B	1	8FA0525917500
*	56	CV6231924207	Thermistor Ass'y K	TKS292B/292B	1	8FA0525917600
	57	CV6231947404	Washer Special	SPHC	1	8522131810401
	58	CV6380126705	Funa	SUS305-WSA	1	3927506010
	59	CV6233001944	Tube Ass'y		1	8520420711800
	60	CV6231917346	Mounting Plate		1	8522238515601
	61	CV6231931915	Mounting Plate		1	8522238515701
	62	CV6231917292	Packing		1	8522238098210
	63	CV6231926119	Elec. Wiring Diagram	SELF DIAGNO	1	8FA2525768500
*	64	CV6231704267	Solenoid Control Valve	UKV-18D13	3	8542454815000
	65	CV6231638074	Screw Special		4	8522239615401
*	66	CV6231932110	Heater K	SP4407Q-09	1	8FA0525503400
*	67	CV6231958097	Pressure Switch	ACB-1UB42W	1	1FA4S1H008500
	68	CV6233136370	Packing		2	8522238093710
	69	CV6233136363	Packing		2	8522238092810
	70	CV6233136356	Packing		1	8522252817310
	71	CV6233136349	Packing		1	8522252816510
	72	CV6233136332	Packing		1	8522252819610
	73	CV6233136400	Packing		2	8522252816610
	74	CV6233136394	Packing		1	8522252816710
	75	CV6233136387	Screw Special		4	8522239622201
	76	CV6230516519	Cushion Rubber		4	8522239019200
	77	CV6233188911	Caution Label		1	8546575944300
	78	CV6233190785	Mounting Plate		1	8522238531801
		CV6233187761	Installation Instructions		1	8526419058100
		CV6233187778	Installation Instructions		1	8526419058000

NOTE: Metal and plastic parts will be supplied basically with necessary heat insulation pads or packing. Each key number with an asterisk (*) means the recommended service parts.

ATTENTION!

To ensure correct parts supply, please let us know the following,

Part No. when you make service parts order:

1.Part No. 2.Description 3.Q'ty 4.Volts-Hz-Ph 5.Product Mode No.

CU-3KS19NBU
OUTDOOR UNIT

KeyNo.	Part No.	Description	Model Number	Q'ty	Reference No.
	CV6233187754	Installation Instructions		1	8526419058200

NOTE: Metal and plastic parts will be supplied basically with necessary heat insulation pads or packing.
Each key number with an asterisk (*) means the recommended service parts.

CU-4KS24NBU
OUTDOOR UNIT

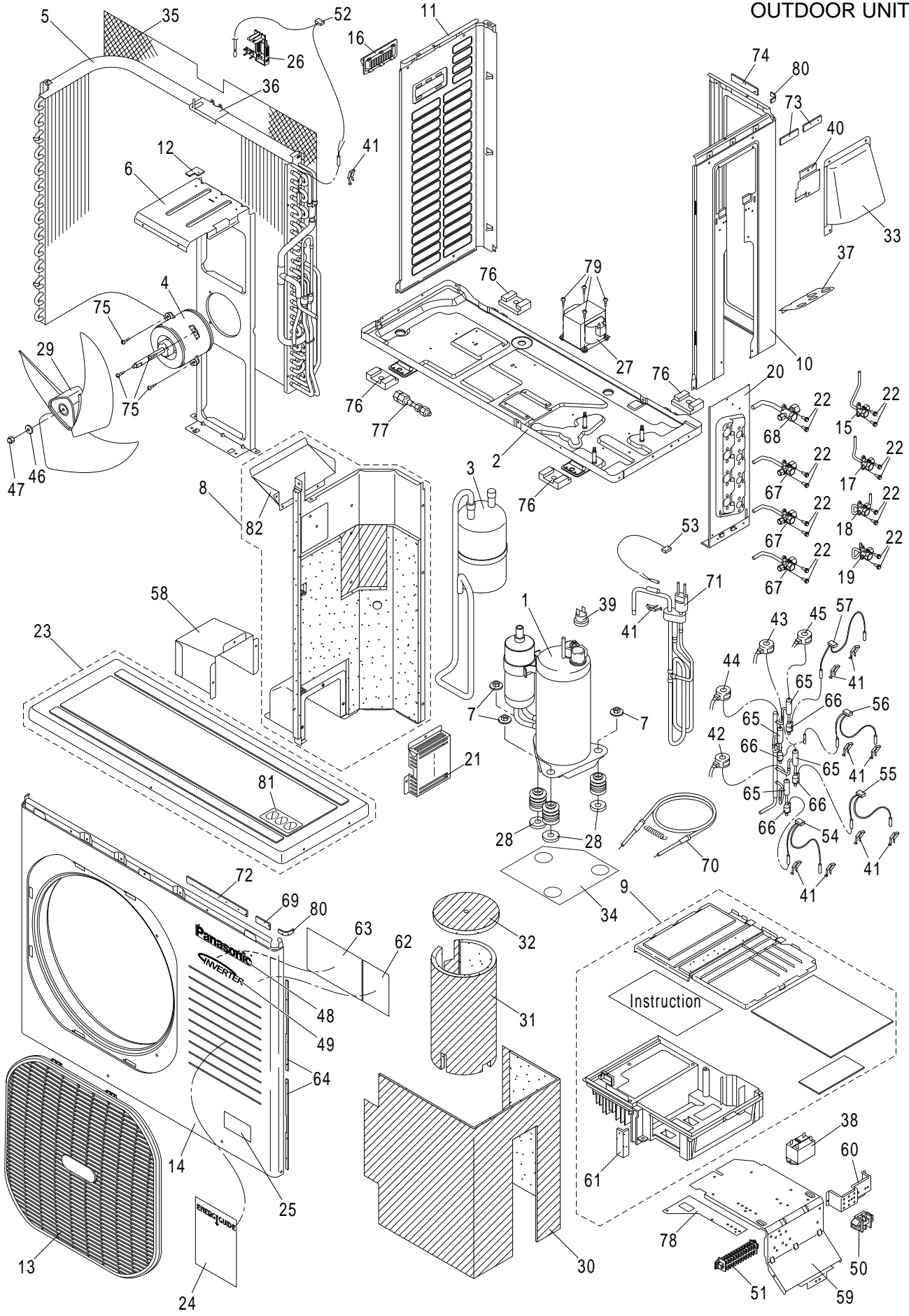

ATTENTION!

To ensure correct parts supply, please let us know the following,

Part No. when you make service parts order:

1.Part No. 2.Description 3.Q'ty 4.Volts-Hz-Ph 5.Product Mode No.

CU-4KS24NBU
OUTDOOR UNIT

KeyNo.	Part No.	Description	Model Number	Q'ty	Reference No.
* 1	CV6231924016	Comp Sub Ass'y	5KD240XAB21	1	8520452634100
2	CV6233136233	Bottom Plate Ass'y		1	8520220280002
3	CV6231924009	Accumulator Ass'y		1	8520451131400
* 4	CV6231915427	Fan Motor	SIC-71FW-D490-1	1	1FA4M4A010400
5	CV6231931830	Heat Exch Cond Ass'y		1	8520411920300
6	CV6231915403	Mounting Plate, Fan Motor		1	8522235431400
7	CV6231938068	Nut Special		3	8522222615501
8	CV6233188843	Partition Plate Ass'y		1	8520220953000
* 9	CV6233189024	Controller Assy(Including PCB)	CB-CU-4KS24NBU-SRV	1	8549953605960
10	CV6233136264	Side Panel		1	8522111442301
11	CV6233136257	Side Panel		1	8522111441302
12	CV6233136356	Packing		1	8522252817310
13	CV6231917858	Guard		1	8522132124211
14	CV6233136240	Front Panel		1	8522111824702
15	CV6231924368	Valve Ass'y 1/4"		1	8520451543900
16	CV6231917186	Handle		1	8522230317811
17	CV6231924092	Valve Ass'y 1/4"		1	8520451544000
18	CV6231924085	Valve Ass'y 1/4"		1	8520451544100
19	CV6231924078	Valve Ass'y 1/4"		1	8520451544200
20	CV6233136417	Support Valve		1	8522222238301
21	CV6231917421	Cover Plate		1	8522531549101
22	CV6233147437	S Tite Screw		16	3920461601
23	CV6233188881	Top Plate Ass'y		1	8520110326200
24	CV6233189031	Ftc Tag		1	8526445925300
25	CV6231611497	Label		1	8542135895900
26	CV6231719278	Mounting Thermostat		1	8522530324501
* 27	CV6231917902	Reactor	R9020A-TE-COV	1	1FA4L5C013500
28	CV6231915618	Cushion Rubber		3	8522239030800
* 29	CV6233043500	Propeller Fan Ass'y		1	8520250218900
30	CV6231924115	Insulation		1	8522247669300
31	CV6231924108	Insulation		1	8522247671900
32	CV6231915632	Insulation		1	8522247672000
33	CV6233136318	Cover Ass'y		1	8520230925120
34	CV6231915526	Sheet		1	8522532850000
35	CV6231917926	Guard		1	8522132124700
36	CV6231915540	Mounting Plate		1	8522238515801
37	CV6233136424	Conduit Plate		1	8522131944921
* 38	CV6231727730	Power Relay	EL200/240A1-F(M)	1	1FA4S2A010000
* 39	CV6233106328	Thermistor Ass'y	CS-7L-2515	1	8FA0515500700
40	CV6233136295	Mounting Plate		1	8522238517802

NOTE: Metal and plastic parts will be supplied basically with necessary heat insulation pads or packing. Each key number with an asterisk (*) means the recommended service parts.

ATTENTION!

To ensure correct parts supply, please let us know the following,

Part No. when you make service parts order:

1.Part No. 2.Description 3.Q'ty 4.Volts-Hz-Ph 5.Product Mode No.

CU-4KS24NBU
OUTDOOR UNIT

KeyNo.	Part No.	Description	Model Number	Q'ty	Reference No.	
41	CV6231485876	Mounting Thermostat		10	8522530322401	
*	42	CV6231924184	Magnetic Coil	UKV-A014 5P A-MV	1	8FA0525115200
*	43	CV6231924177	Magnetic Coil	UKV-A006 5P B-MV	1	8FA0525115300
*	44	CV6231924160	Magnetic Coil	UKV-A007 5P C-MV	1	8FA0525115400
*	45	CV6231924399	Magnetic Coil	UKV-A008 5P D-MV	1	8FA0525115500
	46	CV6231947404	Washer Special		1	8522131810401
	47	CV6380126705	Funa	SUS305-WSA	1	3927506010
	48	CV6233172071	Badge		1	8542135433401
	49	CV6233174174	Badge		1	8542135433301
*	50	CV6233188898	Terminal Base	JTU30-2U-SA0588	1	1FA4J3A048800
*	51	CV6231931953	Terminal Base	KTU15N-12J	1	1FA4J3A026600
*	52	CV6231924245	Thermistor Ass'y K	TKS292B/295B	1	8FA0525916700
*	53	CV6231924238	Thermistor Ass'y K	TKS293B	1	8FA0525916900
*	54	CV6231924221	Thermistor Ass'y K	TKS292B/292B	1	8FA0525917400
*	55	CV6231924214	Thermistor Ass'y K	TKS292B/292B	1	8FA0525917500
*	56	CV6231924207	Thermistor Ass'y K	TKS292B/292B	1	8FA0525917600
*	57	CV6231924412	Thermistor Ass'y K	TKS292B/292B	1	8FA0525917700
	58	CV6233188904	Cover		1	8522251535501
	59	CV6231917346	Mounting Plate		1	8522238515601
	60	CV6231931915	Mounting Plate		1	8522238515701
	61	CV6231917292	Packing		1	8522238098210
	62	CV6231926119	Elec. Wiring Diagram	SELF DIAGNO	1	8FA2525768500
	63	CV6233189048	Elec. Wiring Diagram		1	8FA2525111600
	64	CV6233136363	Packing		2	8522238092810
*	65	CV6231704267	Solenoid Control Valve	UKV-18D13	4	8542454815000
	66	CV6231552424	Strainer Ass'y		4	8520450619500
	67	CV6231955447	Valve Ass'y 3/8"		3	8520451827200
	68	CV6231955454	Valve Ass'y 1/2"		1	8520452221400
	69	CV6233136349	Packing		1	8522252816510
*	70	CV6231932110	Heator K	SP4407Q-09	1	8FA0525503400
*	71	CV6231958097	Pressure Switch	ACB-1UB42W	1	1FA4S1H008500
	72	CV6233136332	Packing		1	8522252819610
	73	CV6233136400	Packing		2	8522252816610
	74	CV6233136394	Packing		1	8522252816710
	75	CV6233136387	Screw Special		4	8522239622201
	76	CV6230516519	Cushion Rubber		4	8522239019200
	77	CV6231740593	Tube Ass'y		1	8520420718100
	78	CV6231947459	Mounting Plate		1	8522238518701
	79	CV6231638074	Screw Special		4	8522239615401
	80	CV6233136370	Packing		2	8522238093710

NOTE: Metal and plastic parts will be supplied basically with necessary heat insulation pads or packing. Each key number with an asterisk (*) means the recommended service parts.

ATTENTION!

To ensure correct parts supply, please let us know the following,

Part No. when you make service parts order:

1.Part No. 2.Description 3.Q'ty 4.Volts-Hz-Ph 5.Product Mode No.

CU-4KS24NBU
OUTDOOR UNIT

KeyNo.	Part No.	Description	Model Number	Q'ty	Reference No.
81	CV6233188911	Caution Label		1	8546575944300
82	CV6233190785	Mounting Plate		1	8522238531801
	CV6233187761	Installation Instructions		1	8526419058100
	CV6233187778	Installation Instructions		1	8526419058000
	CV6233187754	Installation Instructions		1	8526419058200

NOTE: Metal and plastic parts will be supplied basically with necessary heat insulation pads or packing. Each key number with an asterisk (*) means the recommended service parts.

CU-4KS31NBU
OUTDOOR UNIT

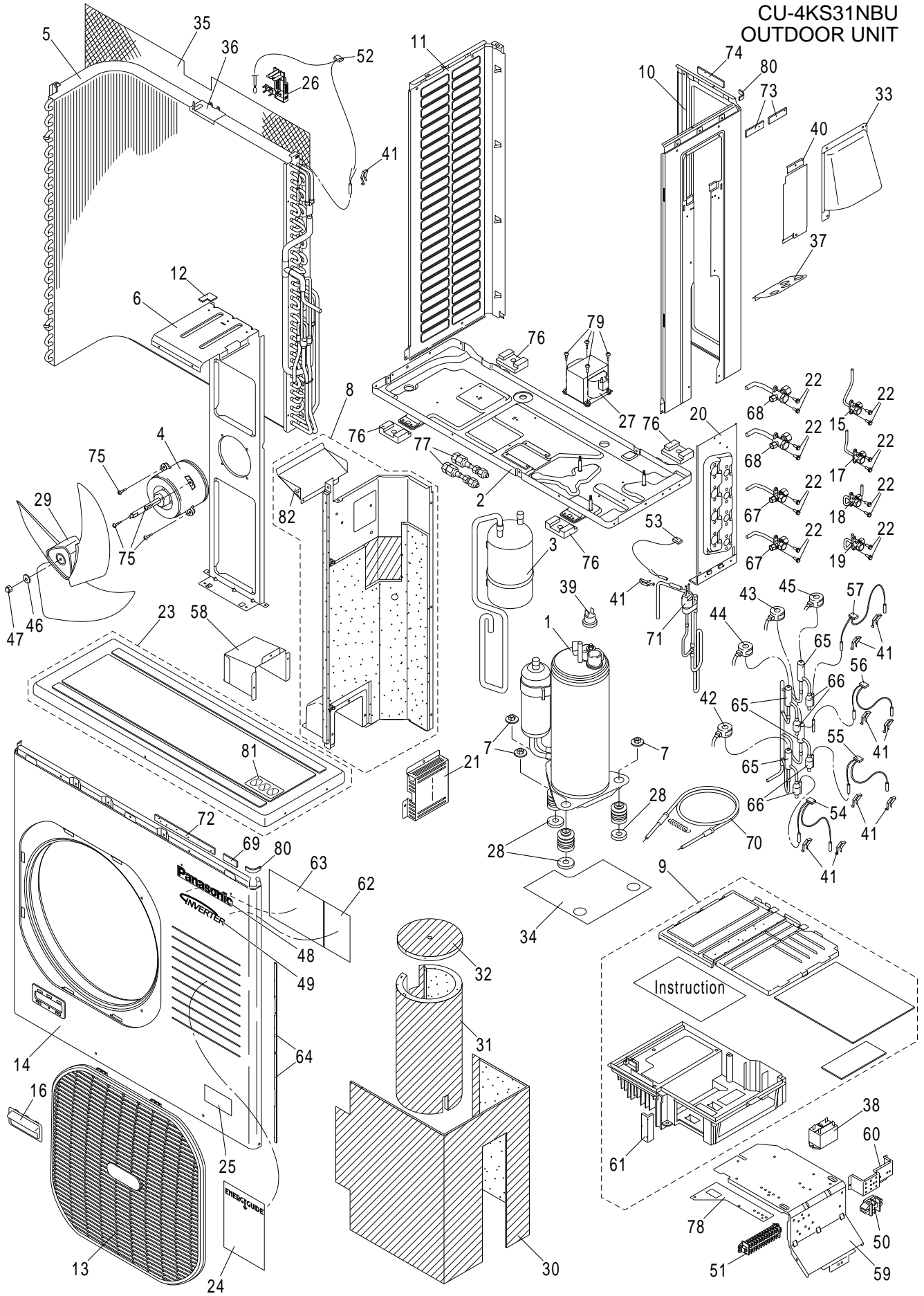

ATTENTION!

To ensure correct parts supply, please let us know the following,

Part No. when you make service parts order:

1.Part No. 2.Description 3.Q'ty 4.Volts-Hz-Ph 5.Product Mode No.

CU-4KS31NBU
OUTDOOR UNIT

KeyNo.	Part No.	Description	Model Number	Q'ty	Reference No.
* 1	CV6231924498	Comp Sub Ass'y	5JD420XAB22	1	8520452634000
2	CV6233136455	Bottom Plate Ass'y		1	8520220280602
3	CV6231924474	Accumulator Ass'y		1	8520451131200
* 4	CV6231915427	Fan Motor	SIC-71FW-D490-1	1	1FA4M4A010400
5	CV6231931991	Heat Exch Cond Ass'y		1	8520411919000
6	CV6231924450	Mounting Plate, Fan Motor		1	8522235431200
7	CV6231938068	Nut Special		3	8522222615501
8	CV6233189055	Partition Plate Ass'y		1	8520220953300
* 9	CV6233189062	Controller Assy(Including PCB)	CB-CU-4KS31NBU-SRV	1	8549953605958
10	CV6233136486	Side Panel		1	8522111441602
11	CV6233136479	Side Panel		1	8522111441002
12	CV6233136356	Packing		1	8522252817310
13	CV6231917858	Guard		1	8522132124211
14	CV6233136462	Front Panel		1	8522111824602
15	CV6231924368	Valve Ass'y 1/4"		1	8520451543900
16	CV6231917186	Handle		1	8522230317811
17	CV6231924092	Valve Ass'y 1/4"		1	8520451544000
18	CV6231924085	Valve Ass'y 1/4"		1	8520451544100
19	CV6231924078	Valve Ass'y 1/4"		1	8520451544200
20	CV6233136417	Support Valve		1	8522222238301
21	CV6231917421	Cover Plate		1	8522531549101
22	CV6233147437	S Tite Screw		16	3920461601
23	CV6233188881	Top Plate Ass'y		1	8520110326200
24	CV6233189079	Ftc Tag		1	8526445925400
25	CV6231611497	Label		1	8542135895900
26	CV6231719278	Mounting Thermostat		1	8522530324501
* 27	CV6231917902	Reactor	R9020A-TE-COV	1	1FA4L5C013500
28	CV6231915618	Cushion Rubber		3	8522239030800
* 29	CV6233043500	Propeller Fan Ass'y		1	8520250218900
30	CV6231924115	Insulation		1	8522247669300
31	CV6231924542	Insulation		1	8522247671700
32	CV6231924535	Insulation		1	8522247671800
33	CV6233136318	Cover Ass'y		1	8520230925120
34	CV6231924573	Sheet		1	8522532849800
35	CV6231932059	Guard		1	8522132124600
36	CV6231915540	Mounting Plate		1	8522238515801
37	CV6233136424	Conduit Plate		1	8522131944921
* 38	CV6231727730	Power Relay	EL200/240A1-F(M)	1	1FA4S2A010000
* 39	CV6233106328	Thermistor Ass'y	CS-7L-2515	1	8FA0515500700
40	CV6233136493	Mounting Plate		1	8522238517702

NOTE: Metal and plastic parts will be supplied basically with necessary heat insulation pads or packing. Each key number with an asterisk (*) means the recommended service parts.

ATTENTION!

To ensure correct parts supply, please let us know the following,

Part No. when you make service parts order:

1.Part No. 2.Description 3.Q'ty 4.Volts-Hz-Ph 5.Product Mode No.

CU-4KS31NBU
OUTDOOR UNIT

KeyNo.	Part No.	Description	Model Number	Q'ty	Reference No.	
41	CV6231485876	Mounting Thermostat		10	8522530322401	
*	42	CV6231924641	Magnetic Coil	UKV-A009 5P A-MV	1	8FA0525115600
*	43	CV6231924634	Magnetic Coil	UKV-A010 5P B-MV	1	8FA0525115700
*	44	CV6231924627	Magnetic Coil	UKV-A011 5P C-MV	1	8FA0525115800
*	45	CV6231924610	Magnetic Coil	UKV-A012 5P D-MV	1	8FA0525115900
	46	CV6231947404	Washer Special		1	8522131810401
	47	CV6380126705	Funa	SUS305-WSA	1	3927506010
	48	CV6233172071	Badge		1	8542135433401
	49	CV6233174174	Badge		1	8542135433301
*	50	CV6233188898	Terminal Base	JTU30-2U-SA0588	1	1FA4J3A048800
*	51	CV6231931953	Terminal Base	KTU15N-12J	1	1FA4J3A026600
*	52	CV6231924702	Thermistor Ass'y K	TKS292B/295B	1	8FA0525922600
*	53	CV6231924696	Thermistor Ass'y K	TKS293B	1	8FA0525917000
*	54	CV6231924689	Thermistor Ass'y K	TKS292B/292B	1	8FA0525917800
*	55	CV6231924672	Thermistor Ass'y K	TKS292B/292B	1	8FA0525917900
*	56	CV6231924665	Thermistor Ass'y K	TKS292B/292B	1	8FA0525918000
*	57	CV6231924726	Thermistor Ass'y K	TKS292B/292B	1	8FA0525918100
	58	CV6233188904	Cover		1	8522251535501
	59	CV6231917346	Mounting Plate		1	8522238515601
	60	CV6231931915	Mounting Plate		1	8522238515701
	61	CV6231917292	Packing		1	8522238098210
	62	CV6231926119	Elec. Wiring Diagram	SELF DIAGNO	1	8FA2525768500
	63	CV6233189086	Elec. Wiring Diagram		1	8FA2525111400
	64	CV6233136363	Packing		2	8522238092810
*	65	CV6231704267	Solenoid Control Valve	UKV-18D13	4	8542454815000
	66	CV6231552424	Strainer Ass'y		4	8520450619500
	67	CV6231951210	Valve Ass'y 3/8"		2	8520451827000
	68	CV6231951203	Valve Ass'y 1/2"		2	8520452221200
	69	CV6233136349	Packing		1	8522252816510
*	70	CV6231932196	Heater K	SP4407Q-10	1	8FA0525503500
*	71	CV6231958097	Pressure Switch	ACB-1UB42W	1	1FA4S1H008500
	72	CV6233136332	Packing		1	8522252819610
	73	CV6233136400	Packing		2	8522252816610
	74	CV6233136394	Packing		1	8522252816710
	75	CV6233136387	Screw Special		4	8522239622201
	76	CV6230516519	Cushion Rubber		4	8522239019200
	77	CV6231740593	Tube Ass'y		2	8520420718100
	78	CV6231947459	Mounting Plate		1	8522238518701
	79	CV6231638074	Screw Special		4	8522239615401
	80	CV6233136370	Packing		2	8522238093710

NOTE: Metal and plastic parts will be supplied basically with necessary heat insulation pads or packing. Each key number with an asterisk (*) means the recommended service parts.

ATTENTION!

To ensure correct parts supply, please let us know the following,

Part No. when you make service parts order:

1.Part No. 2.Description 3.Q'ty 4.Volts-Hz-Ph 5.Product Mode No.

CU-4KS31NBU
OUTDOOR UNIT

KeyNo.	Part No.	Description	Model Number	Q'ty	Reference No.
81	CV6233188911	Caution Label		1	8546575944300
82	CV6233190785	Mounting Plate		1	8522238531801
	CV6233187761	Installation Instructions		1	8526419058100
	CV6233187778	Installation Instructions		1	8526419058000
	CV6233187754	Installation Instructions		1	8526419058200

NOTE: Metal and plastic parts will be supplied basically with necessary heat insulation pads or packing. Each key number with an asterisk (*) means the recommended service parts.

CU-3KE19NBU
OUTDOOR UNIT

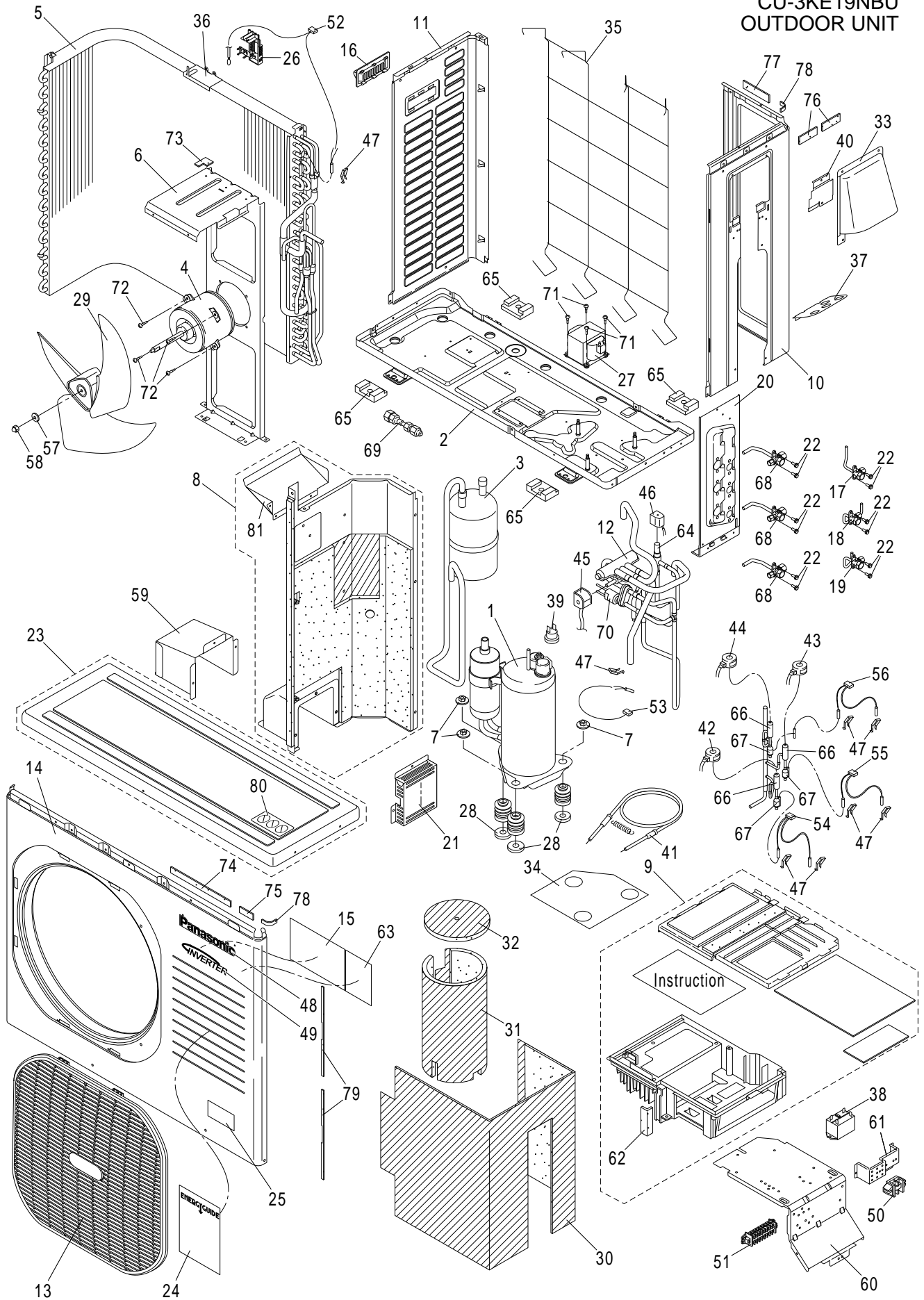

ATTENTION!

To ensure correct parts supply, please let us know the following,

Part No. when you make service parts order:

1.Part No. 2.Description 3.Q'ty 4.Volts-Hz-Ph 5.Product Mode No.

CU-3KE19NBU
OUTDOOR UNIT

KeyNo.	Part No.	Description	Model Number	Q'ty	Reference No.
* 1	CV6231924016	Comp Sub Ass'y	5KD240XAB21	1	8520452634100
2	CV6233136516	Bottom Plate Ass'y		1	8520220279402
3	CV6231924009	Accumulator Ass'y		1	8520451131400
* 4	CV6231915427	Fan Motor	SIC-71FW-D490-1	1	1FA4M4A010400
5	CV6231923996	Heat Exch Cond Ass'y		1	8520411919100
6	CV6231915403	Mounting Plate, Fan Motor		1	8522235431400
7	CV6231938068	Nut Special		3	8522222615501
8	CV6233188843	Partition Plate Ass'y		1	8520220953000
* 9	CV6233188867	Controller Assy(Including PCB)	CB-CU-3KE19NBU-SRV	1	8549953605961
10	CV6233136264	Side Panel		1	8522111442301
11	CV6233136257	Side Panel		1	8522111441302
* 12	CV6231917445	Solenoid Valve Ass'y	STF-02U2G	1	8520450922800
13	CV6231917858	Guard		1	8522132124211
14	CV6233136240	Front Panel		1	8522111824702
15	CV6233188850	Elec. Wiring Diagram		1	8FA2525111700
16	CV6231917186	Handle		1	8522230317811
17	CV6231924092	Valve Ass'y 1/4"		1	8520451544000
18	CV6231924085	Valve Ass'y 1/4"		1	8520451544100
19	CV6231924078	Valve Ass'y 1/4"		1	8520451544200
20	CV6233136288	Support Valve		1	8522222238701
21	CV6231917421	Cover Plate		1	8522531549101
22	CV6233147437	S Tite Screw		12	3920461601
23	CV6233188881	Top Plate Ass'y		1	8520110326200
24	CV6233188874	Ftc Tag		1	8526445925500
25	CV6231611497	Label		1	8542135895900
26	CV6231719278	Mounting Thermostat		1	8522530324501
* 27	CV6231917902	Reactor	R9020A-TE-COV	1	1FA4L5C013500
28	CV6231915618	Cushion Rubber		3	8522239030800
* 29	CV6233043500	Propeller Fan Ass'y		1	8520250218900
30	CV6231924115	Insulation		1	8522247669300
31	CV6231924108	Insulation		1	8522247671900
32	CV6231915632	Insulation		1	8522247672000
33	CV6233136318	Cover Ass'y		1	8520230925120
34	CV6231915526	Sheet		1	8522532850000
35	CV6231915557	Guard Ass'y		1	8520111123801
36	CV6231915540	Mounting Plate		1	8522238515801
37	CV6233136301	Conduit Plate		1	8522131945121
* 38	CV6231727730	Power Relay	EL200/240A1-F(M)	1	1FA4S2A010000
* 39	CV6233106328	Thermistor Ass'y	CS-7L-2515	1	8FA0515500700
40	CV6233136295	Mounting Plate		1	8522238517802

NOTE: Metal and plastic parts will be supplied basically with necessary heat insulation pads or packing. Each key number with an asterisk (*) means the recommended service parts.

ATTENTION!

To ensure correct parts supply, please let us know the following,

Part No. when you make service parts order:

1.Part No. 2.Description 3.Q'ty 4.Volts-Hz-Ph 5.Product Mode No.

CU-3KE19NBU
OUTDOOR UNIT

KeyNo.	Part No.	Description	Model Number	Q'ty	Reference No.
* 41	CV6231932110	Heater K	SP4407Q-09	1	8FA0525503400
* 42	CV6231924184	Magnetic Coil	UKV-A014 5P A-MV	1	8FA0525115200
* 43	CV6231924177	Magnetic Coil	UKV-A006 5P B-MV	1	8FA0525115300
* 44	CV6231924160	Magnetic Coil	UKV-A007 5P C-MV	1	8FA0525115400
* 45	CV6231918046	Magnetic Coil	STF-01AQ503UA1	1	8FA0525114600
* 46	CV6231932103	Magnetic Coil	VPV-MOAQ533UB1	1	8FA0525114700
47	CV6231485876	Mounting Thermostat		8	8522530322401
48	CV6233172071	Badge		1	8542135433401
49	CV6233174174	Badge		1	8542135433301
* 50	CV6233188898	Terminal Base	JTU30-2U-SA0588	1	1FA4J3A048800
* 51	CV6231931908	Terminal Base	KTU15N-9J	1	1FA4J3A026500
* 52	CV6231924245	Thermistor Ass'y K	TKS292B/295B	1	8FA0525916700
* 53	CV6231924238	Thermistor Ass'y K	TKS293B	1	8FA0525916900
* 54	CV6231924221	Thermistor Ass'y K	TKS292B/292B	1	8FA0525917400
* 55	CV6231924214	Thermistor Ass'y K	TKS292B/292B	1	8FA0525917500
* 56	CV6231924207	Thermistor Ass'y K	TKS292B/292B	1	8FA0525917600
57	CV6231947404	Washer Special	SPHC	1	8522131810401
58	CV6380126705	Funa 6	SUS305-WSA	1	3927506010
59	CV6233188904	Cover		1	8522251535501
60	CV6231917346	Mounting Plate		1	8522238515601
61	CV6231931915	Mounting Plate		1	8522238515701
62	CV6231917292	Packing		1	8522238098210
63	CV6231926119	Elec. Wiring Diagram	SELF DIAGNO	1	8FA2525768500
* 64	CV6231932127	Solenoid Valve Ass'y	VPV-603DU	1	8520450923000
65	CV6230516519	Cushion Rubber		4	8522239019200
* 66	CV6231704267	Solenoid Control Valve	UKV-18D13	3	8542454815000
67	CV6231552424	Strainer Ass'y		3	8520450619500
68	CV6231955447	Valve Ass'y 3/8"		3	8520451827200
69	CV6233001944	Tube Ass'y		1	8520420711800
* 70	CV6231958097	Pressure Switch	ACB-1UB42W	1	1FA4S1H008500
71	CV6231638074	Screw Special		4	8522239615401
72	CV6233136387	Screw Special		4	8522239622201
73	CV6233136356	Packing		1	8522252817310
74	CV6233136356	Packing		1	8522252817310
75	CV6233136349	Packing		1	8522252816510
76	CV6233136400	Packing		2	8522252816610
77	CV6233136394	Packing		1	8522252816710
78	CV6233136370	Packing		2	8522238093710
79	CV6233136363	Packing		2	8522238092810
80	CV6233188911	Caution Label		1	8546575944300

NOTE: Metal and plastic parts will be supplied basically with necessary heat insulation pads or packing. Each key number with an asterisk (*) means the recommended service parts.

ATTENTION!

To ensure correct parts supply, please let us know the following,

Part No. when you make service parts order:

1.Part No. 2.Description 3.Q'ty 4.Volts-Hz-Ph 5.Product Mode No.

CU-3KE19NBU
OUTDOOR UNIT

KeyNo.	Part No.	Description	Model Number	Q'ty	Reference No.
81	CV6233190785	Mounting Plate		1	8522238531801
	CV6233187853	Installation Instructions		1	8526419058400
	CV6233187860	Installation Instructions		1	8526419058300
	CV6233187846	Installation Instructions		1	8526419058500

NOTE: Metal and plastic parts will be supplied basically with necessary heat insulation pads or packing. Each key number with an asterisk (*) means the recommended service parts.

CU-4KE24NBU
OUTDOOR UNIT

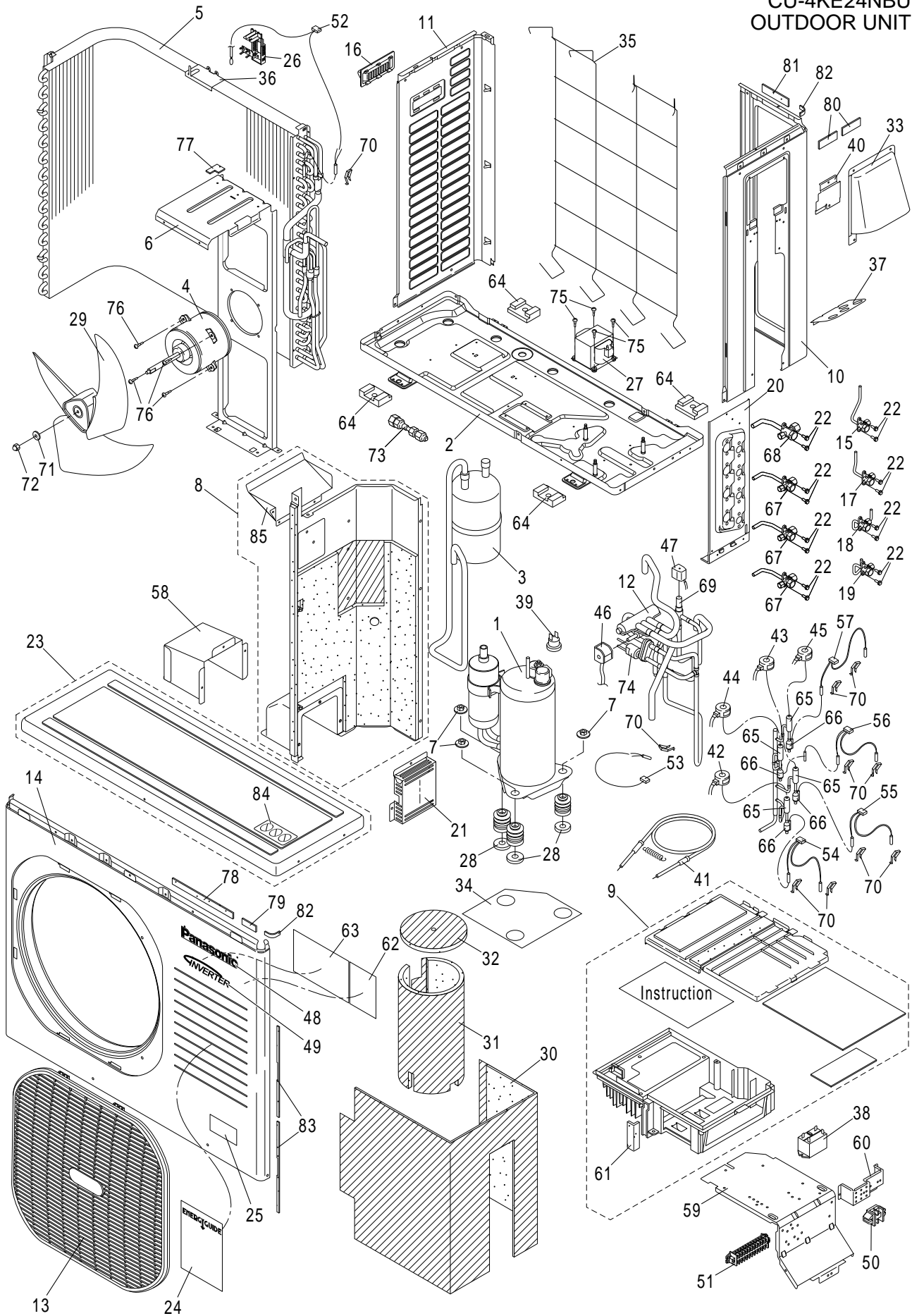

ATTENTION!

To ensure correct parts supply, please let us know the following,

Part No. when you make service parts order:

1.Part No. 2.Description 3.Q'ty 4.Volts-Hz-Ph 5.Product Mode No.

CU-4KE24NBU
OUTDOOR UNIT

KeyNo.	Part No.	Description	Model Number	Q'ty	Reference No.
* 1	CV6231924016	Comp Sub Ass'y	5KD240XAB21	1	8520452634100
2	CV6233136516	Bottom Plate Ass'y		1	8520220279402
3	CV6231924009	Accumulator Ass'y		1	8520451131400
* 4	CV6231915427	Fan Motor	SIC-71FW-D490-1	1	1FA4M4A010400
5	CV6231923996	Heat Exch Cond Ass'y		1	8520411919100
6	CV6231915403	Mounting Plate, Fan Motor		1	8522235431400
7	CV6231938068	Nut Special		3	8522222615501
8	CV6233188843	Partition Plate Ass'y		1	8520220953000
* 9	CV6233188959	Controller Assy(Including PCB)	CB-CU-4KE24NBU-SRV	1	8549953605959
10	CV6233136264	Side Panel		1	8522111442301
11	CV6233136257	Side Panel		1	8522111441302
* 12	CV6231917445	Solenoid Valve Ass'y	STF-02U2G	1	8520450922800
13	CV6231917858	Guard		1	8522132124211
14	CV6233136240	Front Panel		1	8522111824702
15	CV6231924368	Valve Ass'y 1/4"		1	8520451543900
16	CV6231917186	Handle		1	8522230317811
17	CV6231924092	Valve Ass'y 1/4"		1	8520451544000
18	CV6231924085	Valve Ass'y 1/4"		1	8520451544100
19	CV6231924078	Valve Ass'y 1/4"		1	8520451544200
20	CV6233136417	Support Valve		1	8522222238301
21	CV6231917421	Cover Plate		1	8522531549101
22	CV6233147437	S Tite Screw		16	3920461601
23	CV6233188881	Top Plate Ass'y		1	8520110326200
24	CV6233188966	Ftc Tag		1	8526445925600
25	CV6231611497	Label		1	8542135895900
26	CV6231719278	Mounting Thermostat		1	8522530324501
* 27	CV6231917902	Reactor	R9020A-TE-COV	1	1FA4L5C013500
28	CV6231915618	Cushion Rubber		3	8522239030800
* 29	CV6233043500	Propeller Fan Ass'y		1	8520250218900
30	CV6231924115	Insulation		1	8522247669300
31	CV6231924108	Insulation		1	8522247671900
32	CV6231915632	Insulation		1	8522247672000
33	CV6233136318	Cover Ass'y		1	8520230925120
34	CV6231915526	Sheet		1	8522532850000
35	CV6231915557	Guard Ass'y		1	8520111123801
36	CV6231915540	Mounting Plate		1	8522238515801
37	CV6233136424	Conduit Plate		1	8522131944921
* 38	CV6231727730	Power Relay	EL200/240A1-F(M)	1	1FA4S2A010000
* 39	CV6233106328	Thermistor Ass'y	CS-7L-2515	1	8FA0515500700
40	CV6233136295	Mounting Plate		1	8522238517802

NOTE: Metal and plastic parts will be supplied basically with necessary heat insulation pads or packing. Each key number with an asterisk (*) means the recommended service parts.

ATTENTION!

To ensure correct parts supply, please let us know the following,

Part No. when you make service parts order:

1.Part No. 2.Description 3.Q'ty 4.Volts-Hz-Ph 5.Product Mode No.

CU-4KE24NBU
OUTDOOR UNIT

KeyNo.	Part No.	Description	Model Number	Q'ty	Reference No.
* 41	CV6231932110	Heater K	SP4407Q-09	1	8FA0525503400
* 42	CV6231924184	Magnetic Coil	UKV-A014 5P A-MV	1	8FA0525115200
* 43	CV6231924177	Magnetic Coil	UKV-A006 5P B-MV	1	8FA0525115300
* 44	CV6231924160	Magnetic Coil	UKV-A007 5P C-MV	1	8FA0525115400
* 45	CV6231924399	Magnetic Coil	UKV-A008 5P D-MV	1	8FA0525115500
* 46	CV6231918046	Magnetic Coil	STF-01AQ503UA1	1	8FA0525114600
* 47	CV6231932103	Magnetic Coil	VPV-MOAQ533UB1	1	8FA0525114700
48	CV6233172071	Badge		1	8542135433401
49	CV6233174174	Badge		1	8542135433301
* 50	CV6233188898	Terminal Base	JTU30-2U-SA0588	1	1FA4J3A048800
* 51	CV6231931953	Terminal Base	KTU15N-12J	1	1FA4J3A026600
* 52	CV6231924245	Thermistor Ass'y K	TKS292B/295B	1	8FA0525916700
* 53	CV6231924238	Thermistor Ass'y K	TKS293B	1	8FA0525916900
* 54	CV6231924221	Thermistor Ass'y K	TKS292B/292B	1	8FA0525917400
* 55	CV6231924214	Thermistor Ass'y K	TKS292B/292B	1	8FA0525917500
* 56	CV6231924207	Thermistor Ass'y K	TKS292B/292B	1	8FA0525917600
* 57	CV6231924412	Thermistor Ass'y K	TKS292B/292B	1	8FA0525917700
58	CV6233188904	Cover		1	8522251535501
59	CV6231917346	Mounting Plate		1	8522238515601
60	CV6231931915	Mounting Plate		1	8522238515701
61	CV6231917292	Packing		1	8522238098210
62	CV6231926119	Elec. Wiring Diagram	SELF DIAGNO	1	8FA2525768500
63	CV6233188973	Elec. Wiring Diagram		1	8FA2525111500
64	CV6230516519	Cushion Rubber		4	8522239019200
* 65	CV6231704267	Solenoid Control Valve	UKV-18D13	4	8542454815000
66	CV6231552424	Strainer Ass'y		4	8520450619500
67	CV6231955447	Valve Ass'y 3/8"		3	8520451827200
68	CV6231955454	Valve Ass'y 1/2"		1	8520452221400
* 69	CV6231932127	Solenoid Valve Ass'y	VPV-603DU	1	8520450923000
70	CV6231485876	Mounting Thermostat		10	8522530322401
71	CV6231947404	Washer Special		1	8522131810401
72	CV6380126705	Funa 6	SUS305-WSA	1	3927506010
73	CV6231740593	Tube Ass'y		1	8520420718100
* 74	CV6231958097	Pressure Switch	ACB-1UB42W	1	1FA4S1H008500
75	CV6231638074	Screw Special		4	8522239615401
76	CV6233136387	Screw Special		4	8522239622201
77	CV6233136356	Packing		1	8522252817310
78	CV6233136332	Packing		1	8522252819610
79	CV6233136349	Packing		1	8522252816510
80	CV6233136400	Packing		2	8522252816610

NOTE: Metal and plastic parts will be supplied basically with necessary heat insulation pads or packing. Each key number with an asterisk (*) means the recommended service parts.

ATTENTION!

To ensure correct parts supply, please let us know the following,

Part No. when you make service parts order:

1.Part No. 2.Description 3.Q'ty 4.Volts-Hz-Ph 5.Product Mode No.

CU-4KE24NBU
OUTDOOR UNIT

KeyNo.	Part No.	Description	Model Number	Q'ty	Reference No.
81	CV6233136394	Packing		1	8522252816710
82	CV6233136370	Packing		2	8522238093710
83	CV6233136363	Packing		2	8522238092810
84	CV6233188911	Caution Label		1	8546575944300
85	CV6233190785	Mounting Plate		1	8522238531801
	CV6233187860	Installation Instructions		1	8526419058300
	CV6233187846	Installation Instructions		1	8526419058500
	CV6233187853	Installation Instructions		1	8526419058400

NOTE: Metal and plastic parts will be supplied basically with necessary heat insulation pads or packing. Each key number with an asterisk (*) means the recommended service parts.

CU-4KE31NBU
OUTDOOR UNIT

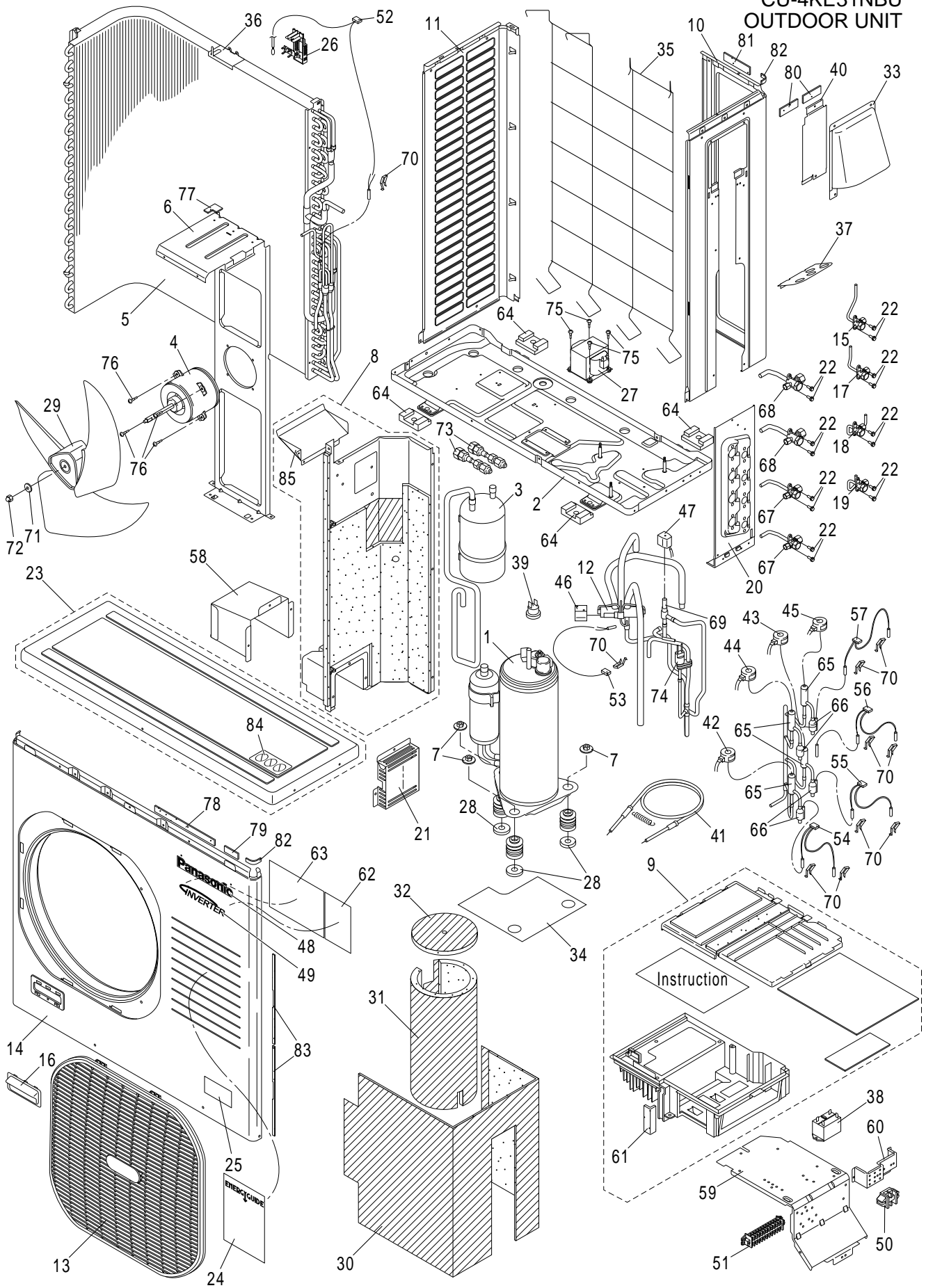

ATTENTION!

To ensure correct parts supply, please let us know the following,

Part No. when you make service parts order:

1.Part No. 2.Description 3.Q'ty 4.Volts-Hz-Ph 5.Product Mode No.

CU-4KE31NBU
OUTDOOR UNIT

KeyNo.	Part No.	Description	Model Number	Q'ty	Reference No.
* 1	CV6231924498	Comp Sub Ass'y	5JD420XAB22	1	8520452634000
2	CV6233136547	Bottom Plate Ass'y		1	8520220279302
3	CV6231924474	Accumulator Ass'y		1	8520451131200
* 4	CV6231915427	Fan Motor	SIC-71FW-D490-1	1	1FA4M4A010400
5	CV6231924467	Heat Exch Cond Ass'y		1	8520411918900
6	CV6231924450	Mounting Plate, Fan Motor		1	8522235431200
7	CV6231938068	Nut Special		3	8522222615501
8	CV6233188980	Partition Plate Ass'y		1	8520220953100
9	CV6233188997	Controller Assy(Including PCB)	CB-CU-4KE31NBU-SRV	1	8549953605957
10	CV6233136486	Side Panel		1	8522111441602
11	CV6233136479	Side Panel		1	8522111441002
* 12	CV6231932165	Solenoid Valve Ass'y	STF-03U1G	1	8520450922900
13	CV6231917858	Guard		1	8522132124211
14	CV6233136462	Front Panel		1	8522111824602
15	CV6231924368	Valve Ass'y 1/4"		1	8520451543900
16	CV6231917186	Handle		1	8522230317811
17	CV6231924092	Valve Ass'y 1/4"		1	8520451544000
18	CV6231924085	Valve Ass'y 1/4"		1	8520451544100
19	CV6231924078	Valve Ass'y 1/4"		1	8520451544200
20	CV6233136417	Support Valve		1	8522222238301
21	CV6231917421	Cover Plate		1	8522531549101
22	CV6233147437	S Tite Screw		16	3920461601
23	CV6233188881	Top Plate Ass'y		1	8520110326200
24	CV6233189000	Ftc Tag		1	8526445925700
25	CV6231611497	Label		1	8542135895900
26	CV6231719278	Mounting Thermostat		1	8522530324501
* 27	CV6231917902	Reactor	R9020A-TE-COV	1	1FA4L5C013500
28	CV6231915618	Cushion Rubber		3	8522239030800
* 29	CV6233043500	Propeller Fan Ass'y		1	8520250218900
30	CV6231924115	Insulation		1	8522247669300
31	CV6231924542	Insulation		1	8522247671700
32	CV6231924535	Insulation		1	8522247671800
33	CV6233136318	Cover Ass'y		1	8520230925120
34	CV6231924573	Sheet		1	8522532849800
35	CV6231924566	Guard Ass'y		1	8520111123501
36	CV6231915540	Mounting Plate		1	8522238515801
37	CV6233136424	Conduit Plate		1	8522131944921
* 38	CV6231727730	Power Relay	EL200/240A1-F(M)	1	1FA4S2A010000
* 39	CV6233106328	Thermistor Ass'y	CS-7L-2515	1	8FA0515500700
40	CV6233136493	Mounting Plate		1	8522238517702

NOTE: Metal and plastic parts will be supplied basically with necessary heat insulation pads or packing. Each key number with an asterisk (*) means the recommended service parts.

ATTENTION!

To ensure correct parts supply, please let us know the following,

Part No. when you make service parts order:

1.Part No. 2.Description 3.Q'ty 4.Volts-Hz-Ph 5.Product Mode No.

CU-4KE31NBU
OUTDOOR UNIT

KeyNo.	Part No.	Description	Model Number	Q'ty	Reference No.
* 41	CV6231932196	Heater K	SP4407Q-10	1	8FA0525503500
* 42	CV6231924641	Magnetic Coil	UKV-A009 5P A-MV	1	8FA0525115600
* 43	CV6231924634	Magnetic Coil	UKV-A010 5P B-MV	1	8FA0525115700
* 44	CV6231924627	Magnetic Coil	UKV-A011 5P C-MV	1	8FA0525115800
* 45	CV6231924610	Magnetic Coil	UKV-A012 5P D-MV	1	8FA0525115900
* 46	CV6231932189	Magnetic Coil	STF-01AQ503UA1	1	8FA0525114800
* 47	CV6231932103	Magnetic Coil	VPV-MOAQ533UB1	1	8FA0525114700
48	CV6233172071	Badge		1	8542135433401
49	CV6233174174	Badge		1	8542135433301
* 50	CV6233188898	Terminal Base	JTU30-2U-SA0588	1	1FA4J3A048800
* 51	CV6231931953	Terminal Base	KTU15N-12J	1	1FA4J3A026600
* 52	CV6231924702	Thermistor Ass'y K	TKS292B/295B	1	8FA0525922600
* 53	CV6231924696	Thermistor Ass'y K	TKS293B	1	8FA0525917000
* 54	CV6231924689	Thermistor Ass'y K	TKS292B/292B	1	8FA0525917800
* 55	CV6231924672	Thermistor Ass'y K	TKS292B/292B	1	8FA0525917900
* 56	CV6231924665	Thermistor Ass'y K	TKS292B/292B	1	8FA0525918000
* 57	CV6231924726	Thermistor Ass'y K	TKS292B/292B	1	8FA0525918100
58	CV6233188904	Cover		1	8522251535501
59	CV6231917346	Mounting Plate		1	8522238515601
60	CV6231931915	Mounting Plate		1	8522238515701
61	CV6231917292	Packing		1	8522238098210
62	CV6231926119	Elec. Wiring Diagram	SELF DIAGNO	1	8FA2525768500
63	CV6233189017	Elec. Wiring Diagram		1	8FA2525111300
64	CV6230516519	Cushion Rubber		4	8522239019200
* 65	CV6231704267	Solenoid Control Valve	UKV-18D13	4	8542454815000
66	CV6231552424	Strainer Ass'y		4	8520450619500
67	CV6231951210	Valve Ass'y 3/8"		2	8520451827000
68	CV6231951203	Valve Ass'y 1/2"		2	8520452221200
* 69	CV6231932127	Solenoid Valve Ass'y	VPV-603DU	1	8520450923000
70	CV6231485876	Mounting Thermostat		10	8522530322401
71	CV6231947404	Washer Special		1	8522131810401
72	CV6380126705	Funa 6	SUS305-WSA	1	3927506010
73	CV6231740593	Tube Ass'y		2	8520420718100
* 74	CV6231958097	Pressure Switch	ACB-1UB42W	1	1FA4S1H008500
75	CV6231638074	Screw Special		4	8522239615401
76	CV6233136387	Screw Special		4	8522239622201
77	CV6233136356	Packing		1	8522252817310
78	CV6233136332	Packing		1	8522252819610
79	CV6233136349	Packing		1	8522252816510
80	CV6233136400	Packing		2	8522252816610

NOTE: Metal and plastic parts will be supplied basically with necessary heat insulation pads or packing. Each key number with an asterisk (*) means the recommended service parts.

ATTENTION!

To ensure correct parts supply, please let us know the following,

Part No. when you make service parts order:

1.Part No. 2.Description 3.Q'ty 4.Volts-Hz-Ph 5.Product Mode No.

CU-4KE31NBU
OUTDOOR UNIT

KeyNo.	Part No.	Description	Model Number	Q'ty	Reference No.
81	CV6233136394	Packing		1	8522252816710
82	CV6233136370	Packing		2	8522238093710
83	CV6233136363	Packing		2	8522238092810
84	CV6233188911	Caution Label		1	8546575944300
85	CV6233190785	Mounting Plate		1	8522238531801
	CV6233187853	Installation Instructions		1	8526419058400
	CV6233187860	Installation Instructions		1	8526419058300
	CV6233187846	Installation Instructions		1	8526419058500

NOTE: Metal and plastic parts will be supplied basically with necessary heat insulation pads or packing. Each key number with an asterisk (*) means the recommended service parts.

CS-MKS7NKU
INDOOR UNIT

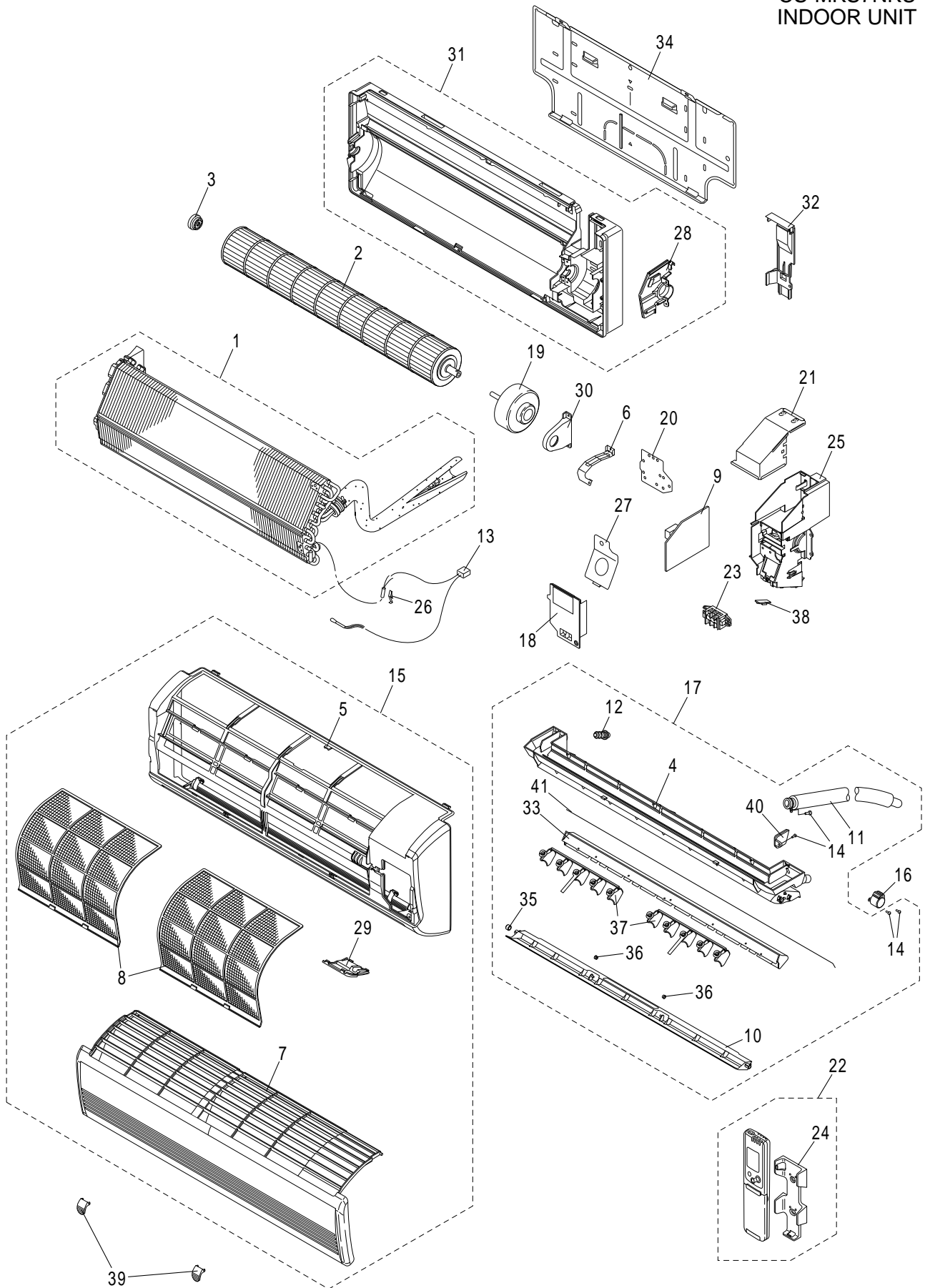

ATTENTION!

To ensure correct parts supply, please let us know the following,

Part No. when you make service parts order:

1.Part No. 2.Description 3.Q'ty 4.Volts-Hz-Ph 5.Product Mode No.

CS-MKS7NKU
INDOOR UNIT

KeyNo.	Part No.	Description	Model Number	Q'ty	Reference No.	
1	CV6231908320	Evaporator Ass'y		1	8520411692800	
*	2	CV6231847018	Cross-Flow Fan Ass'y	1	8520250929300	
*	3	CV6231718318	Bearing Housing Ass'y	1	8520251013200	
4	CV6231908313	Air Outlet Frame		1	8522153120711	
5	CV6233189475	Grille		1	8522150151011	
6	CV6231772150	Mounting Plate		1	8522230997501	
7	CV6233189468	Ornamental Plate		1	8522151638052	
8	CV6233189451	Air Filter Ass'y		2	8520230739301	
*	9	CV6233189512	Circuit Board Ass'y	CB-CS-MKS7NKU	1	8FA0518189200
10	CV6231908344	Flap		1	8522152329211	
11	CV6231772235	Drain Hose Ass'y		1	8520130329400	
12	CV6231718363	Cap, Drain Pan		1	8522234812401	
*	13	CV6233189505	Thermistor Ass'y	PTM-D51H-S4-1	1	8FA0525962900
14	CV6231510646	Screw Special	SWCH18A	4	8522239615101	
15	CV6233189499	Grille Ass'y		1	8520150194100	
*	16	CV6233189482	Step Motor K		1	8FA0526701100
17	CV6233189536	Air Outlet Ass'y		1	8520153141600	
18	CV6231932301	Terminal Cover Ass'y		1	8520530907800	
*	19	CV6233189529	Fan Motor	SIC-41CVJ-D847-4	1	1FA4M5B011700
20	CV6231908375	Mounting Plate		1	8522238514701	
21	CV6231842969	Plate, Elec. Component Box		1	8522530940901	
*	22	CV6233187037	Remote Control Switch	PRCS-3VPSS4E-T	1	8FA0005458900
23	CV6230032996	Terminal Base	KTU15N-3J	1	4237956159	
24	CV6233003573	Holder		1	8512537707701	
25	CV6231908467	Elec. Component Box		1	8522530770001	
26	CV6231485876	Mounting Thermostat		1	8522530322401	
27	CV6231908474	Angle Terminal		1	8522530636101	
28	CV6231908450	Mounting Plate		1	8522230978511	
29	CV6233189543	Sash ORN Ass'y		1	8520130136600	
30	CV6231932318	Mounting Plate, Fan Motor		1	8522235430211	
31	CV6231908429	Frame Ass'y		1	8520220143500	
32	CV6231908412	Mounting, Tube		1	8522236229812	
33	CV6231908511	Guide Air Defl		1	8522236019411	
34	CV6231772433	Rear Panel		1	8522223022501	
35	CV6231469104	Mounting		1	8522151452001	
36	CV6380037209	Mounting		2	8522151444002	
37	CV6231908504	Blade		2	8522151934911	
*	38	CV6231908306	P.C.B. Ass'y	IND-KHS1271	1	8FA0517855900
39	CV6231908481	Cap		2	8522235023811	
40	CV6233189413	Mounting		1	8522151470911	

NOTE: Metal and plastic parts will be supplied basically with necessary heat insulation pads or packing. Each key number with an asterisk (*) means the recommended service parts.

ATTENTION!

To ensure correct parts supply, please let us know the following,

Part No. when you make service parts order:

CS-MKS7NKU
INDOOR UNIT

1.Part No. 2.Description 3.Q'ty 4.Volts-Hz-Ph 5.Product Mode No.

KeyNo.	Part No.	Description	Model Number	Q'ty	Reference No.
41	CV6231932325	Wire	SWP-A	1	8522131536001
	CV6233187648	Operation Manual		1	8526418121400

NOTE: Metal and plastic parts will be supplied basically with necessary heat insulation pads or packing. Each key number with an asterisk (*) means the recommended service parts.

CS-MKS9NKU
INDOOR UNIT

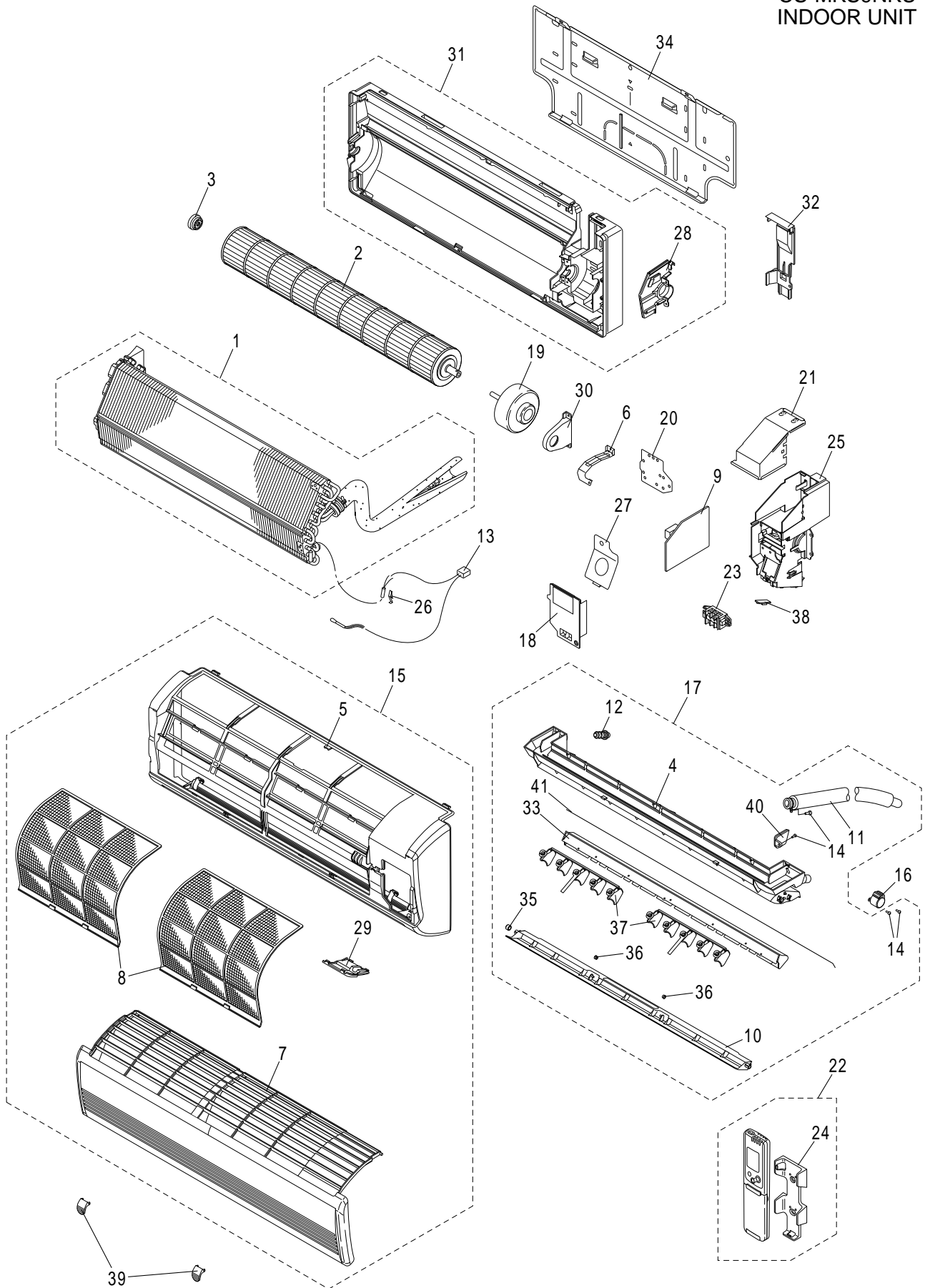

ATTENTION!

To ensure correct parts supply, please let us know the following,

Part No. when you make service parts order:

1.Part No. 2.Description 3.Q'ty 4.Volts-Hz-Ph 5.Product Mode No.

CS-MKS9NKU
INDOOR UNIT

KeyNo.	Part No.	Description	Model Number	Q'ty	Reference No.	
1	CV6231908320	Evaporator Ass'y		1	8520411692800	
*	2	CV6231847018	Cross-Flow Fan Ass'y	1	8520250929300	
*	3	CV6231718318	Bearing Housing Ass'y	1	8520251013200	
4	CV6231908313	Air Outlet Frame		1	8522153120711	
5	CV6233189475	Grille		1	8522150151011	
6	CV6231772150	Mounting Plate		1	8522230997501	
7	CV6233189468	Ornamental Plate		1	8522151638052	
8	CV6233189451	Air Filter Ass'y		2	8520230739301	
*	9	CV6233189550	Circuit Board Ass'y	CB-CS-MKS9NKU	1	8FA0518189300
10	CV6231908344	Flap		1	8522152329211	
11	CV6231772235	Drain Hose Ass'y		1	8520130329400	
12	CV6231718363	Cap, Drain Pan		1	8522234812401	
*	13	CV6233189505	Thermistor Ass'y	PTM-D51H-S4-1	1	8FA0525962900
14	CV6231510646	Screw Special	SWCH18A	4	8522239615101	
15	CV6233189499	Grille Ass'y		1	8520150194100	
*	16	CV6233189482	Step Motor K		1	8FA0526701100
17	CV6233189536	Air Outlet Ass'y		1	8520153141600	
18	CV6231932301	Terminal Cover Ass'y		1	8520530907800	
*	19	CV6233189529	Fan Motor	SIC-41CVJ-D847-4	1	1FA4M5B011700
20	CV6231908375	Mounting Plate		1	8522238514701	
21	CV6231842969	Plate,Elec.Component Box		1	8522530940901	
*	22	CV6233187037	Remote Control Switch	PRCS-3VPSS4E-T	1	8FA0005458900
23	CV6230032996	Terminal Base	KTU15N-3J	1	4237956159	
24	CV6233003573	Holder		1	8512537707701	
25	CV6231908467	Elec. Component Box		1	8522530770001	
26	CV6231485876	Mounting Thermostat		1	8522530322401	
27	CV6231908474	Angle Terminal		1	8522530636101	
28	CV6231908450	Mounting Plate		1	8522230978511	
29	CV6233189543	Sash ORN Ass'y		1	8520130136600	
30	CV6231932318	Mounting Plate, Fan Motor		1	8522235430211	
31	CV6231908429	Frame Ass'y		1	8520220143500	
32	CV6231908412	Mounting, Tube		1	8522236229812	
33	CV6231908511	Guide Air Defl		1	8522236019411	
34	CV6231772433	Rear Panel		1	852223022501	
35	CV6231469104	Mounting		1	8522151452001	
36	CV6380037209	Mounting		2	8522151444002	
37	CV6231908504	Blade		2	8522151934911	
*	38	CV6231908306	P.C.B. Ass'y	IND-KHS1271	1	8FA0517855900
39	CV6231908481	Cap		2	8522235023811	
40	CV6233189413	Mounting		1	8522151470911	

NOTE: Metal and plastic parts will be supplied basically with necessary heat insulation pads or packing. Each key number with an asterisk (*) means the recommended service parts.

ATTENTION!

To ensure correct parts supply, please let us know the following,

Part No. when you make service parts order:

1.Part No. 2.Description 3.Q'ty 4.Volts-Hz-Ph 5.Product Mode No.

CS-MKS9NKU
INDOOR UNIT

KeyNo.	Part No.	Description	Model Number	Q'ty	Reference No.
41	CV6231932325	Wire	SWP-A	1	8522131536001
	CV6233187648	Operation Manual		1	8526418121400

NOTE: Metal and plastic parts will be supplied basically with necessary heat insulation pads or packing.
Each key number with an asterisk (*) means the recommended service parts.

CS-MKS12NKU
INDOOR UNIT

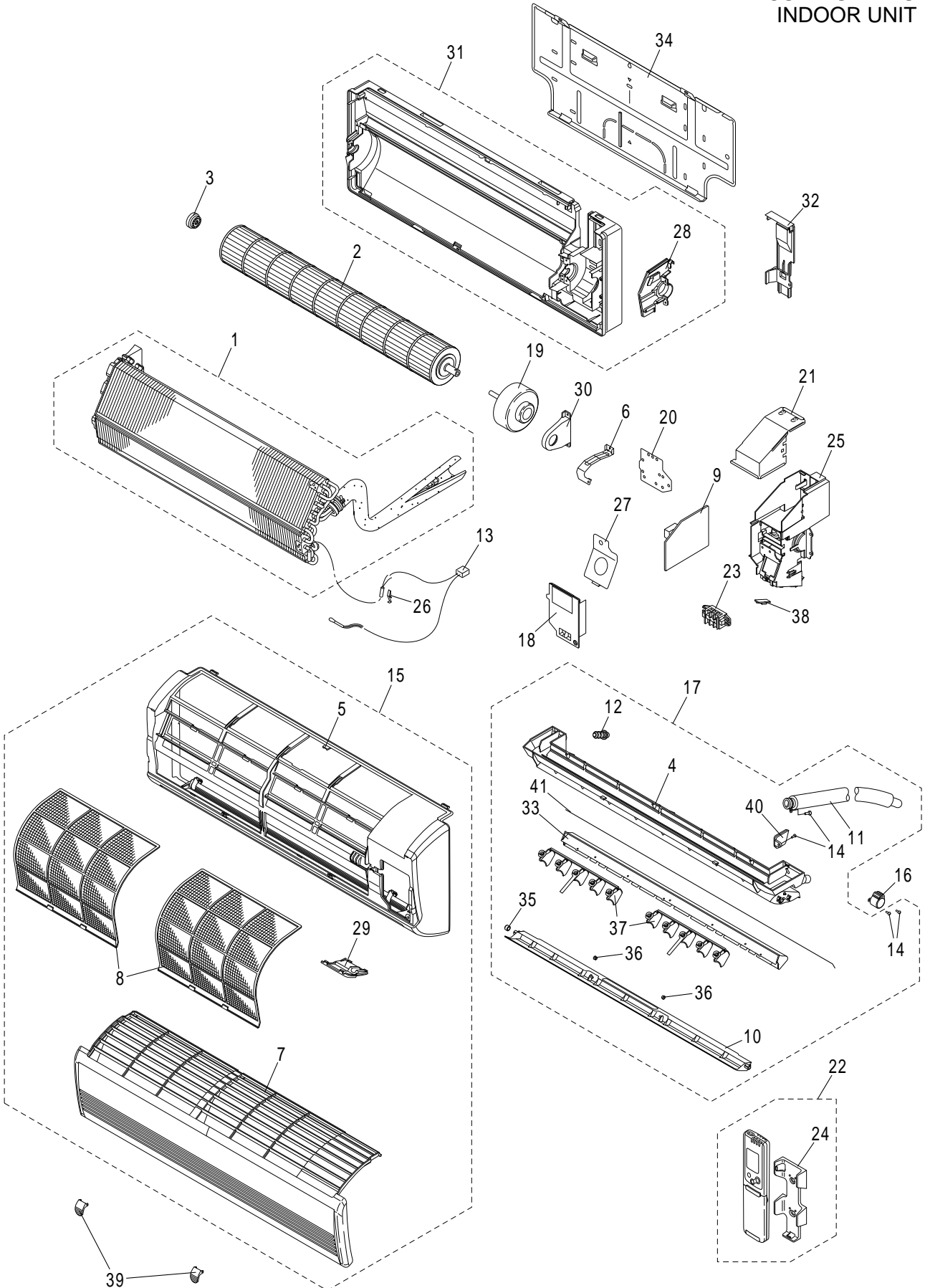

ATTENTION!

To ensure correct parts supply, please let us know the following,

Part No. when you make service parts order:

1.Part No. 2.Description 3.Q'ty 4.Volts-Hz-Ph 5.Product Mode No.

CS-MKS12NKU
INDOOR UNIT

KeyNo.	Part No.	Description	Model Number	Q'ty	Reference No.	
1	CV6231908320	Evaporator Ass'y		1	8520411692800	
*	2	CV6231847018	Cross-Flow Fan Ass'y	1	8520250929300	
*	3	CV6231718318	Bearing Housing Ass'y	1	8520251013200	
4	CV6231908313	Air Outlet Frame		1	8522153120711	
5	CV6233189475	Grille		1	8522150151011	
6	CV6231772150	Mounting Plate		1	8522230997501	
7	CV6233189468	Ornamental Plate		1	8522151638052	
8	CV6233189451	Air Filter Ass'y		2	8520230739301	
*	9	CV6233189567	Circuit Board Ass'y	CB-CS-MKS12NKU	1	8FA0518189400
10	CV6231908344	Flap		1	8522152329211	
11	CV6231772235	Drain Hose Ass'y		1	8520130329400	
12	CV6231718363	Cap, Drain Pan		1	8522234812401	
*	13	CV6233189505	Thermistor Ass'y	PTM-D51H-S4-1	1	8FA0525962900
14	CV6231510646	Screw Special	SWCH18A	4	8522239615101	
15	CV6233189499	Grille Ass'y		1	8520150194100	
*	16	CV6233189482	Step Motor K		1	8FA0526701100
17	CV6233189536	Air Outlet Ass'y		1	8520153141600	
18	CV6231932301	Terminal Cover Ass'y		1	8520530907800	
*	19	CV6233189529	Fan Motor	SIC-41CVJ-D847-4	1	1FA4M5B011700
20	CV6231908375	Mounting Plate		1	8522238514701	
21	CV6231842969	Plate, Elec. Component Box		1	8522530940901	
*	22	CV6233187037	Remote Control Switch	PRCS-3VPSS4E-T	1	8FA0005458900
23	CV6230032996	Terminal Base	KTU15N-3J	1	4237956159	
24	CV6233003573	Holder		1	8512537707701	
25	CV6231908467	Elec. Component Box		1	8522530770001	
26	CV6231485876	Mounting Thermostat		1	8522530322401	
27	CV6231908474	Angle Terminal		1	8522530636101	
28	CV6231908450	Mounting Plate		1	8522230978511	
29	CV6233189543	Sash ORN Ass'y		1	8520130136600	
30	CV6231932318	Mounting Plate, Fan Motor		1	8522235430211	
31	CV6231908429	Frame Ass'y		1	8520220143500	
32	CV6231908412	Mounting, Tube		1	8522236229812	
33	CV6231908511	Guide Air Defl		1	8522236019411	
34	CV6231772433	Rear Panel		1	8522223022501	
35	CV6231469104	Mounting		1	8522151452001	
36	CV6380037209	Mounting		2	8522151444002	
37	CV6231908504	Blade		2	8522151934911	
*	38	CV6231908306	P.C.B. Ass'y	IND-KHS1271	1	8FA0517855900
39	CV6231908481	Cap		2	8522235023811	
40	CV6233189413	Mounting		1	8522151470911	

NOTE: Metal and plastic parts will be supplied basically with necessary heat insulation pads or packing. Each key number with an asterisk (*) means the recommended service parts.

ATTENTION!

To ensure correct parts supply, please let us know the following,

Part No. when you make service parts order:

CS-MKS12NKU
INDOOR UNIT

1.Part No. 2.Description 3.Q'ty 4.Volts-Hz-Ph 5.Product Mode No.

KeyNo.	Part No.	Description	Model Number	Q'ty	Reference No.
41	CV6231932325	Wire	SWP-A	1	8522131536001
	CV6233187648	Operation Manual		1	8526418121400

NOTE: Metal and plastic parts will be supplied basically with necessary heat insulation pads or packing. Each key number with an asterisk (*) means the recommended service parts.

CS-MKS18NKU
INDOOR UNIT

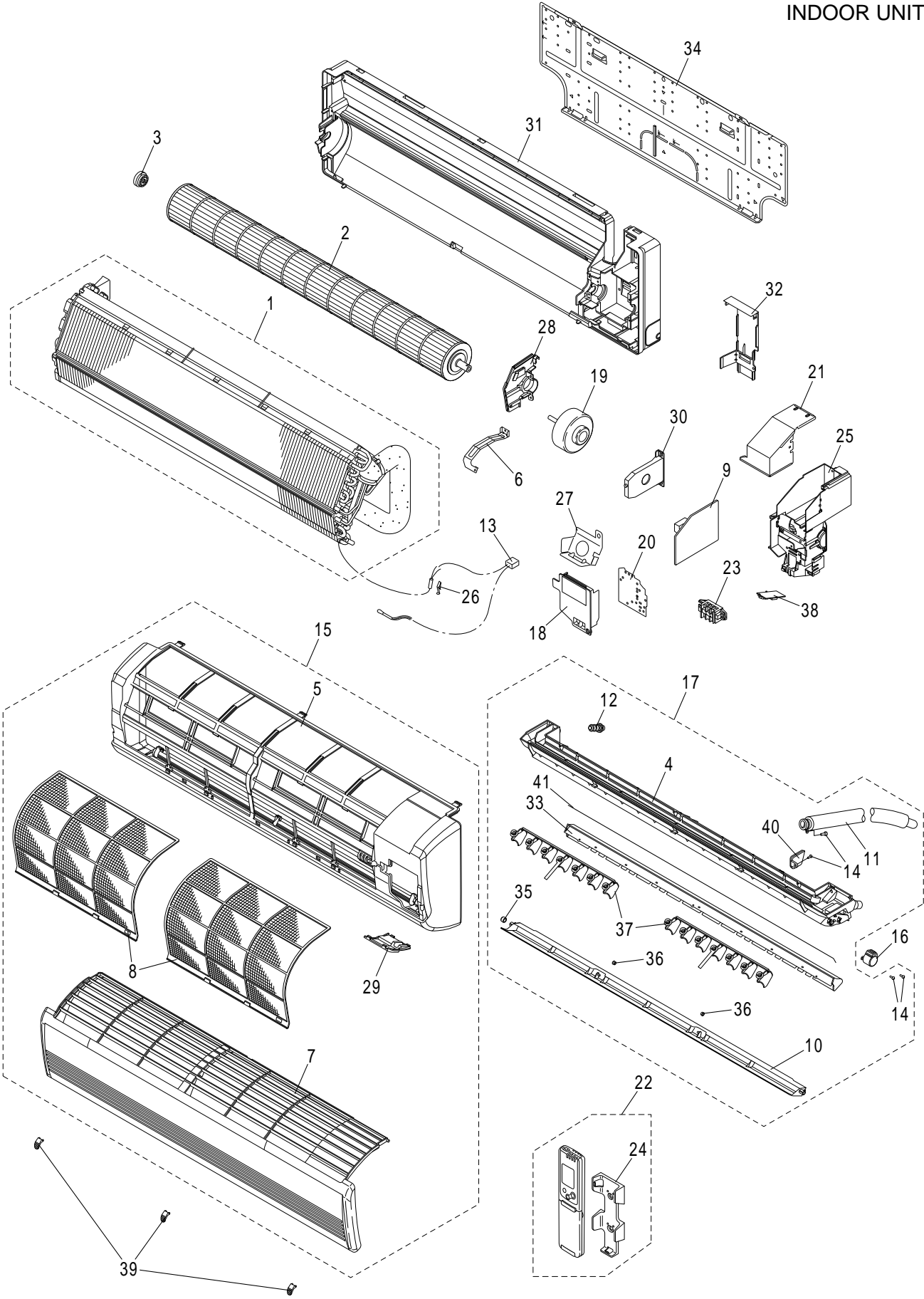

ATTENTION!

To ensure correct parts supply, please let us know the following,

Part No. when you make service parts order:

1.Part No. 2.Description 3.Q'ty 4.Volts-Hz-Ph 5.Product Mode No.

CS-MKS18NKU
INDOOR UNIT

KeyNo.	Part No.	Description	Model Number	Q'ty	Reference No.	
1	CV6231917537	Evaporator Ass'y		1	8520411693000	
*	2	CV6231845397	Cross-Flow Fan Ass'y	1	8520250929200	
*	3	CV6231718318	Bearing Housing Ass'y	1	8520251013200	
4	CV6231917520	Air Outlet Frame		1	8522153121011	
5	CV6231917513	Grille		1	8522150152211	
6	CV6231845366	Mounting Plate		1	8522238512801	
7	CV6233189345	Ornamental Plate		1	8522151638712	
8	CV6233189338	Air Filter Ass'y		2	8520230739201	
*	9	CV6233189574	Circuit Board Ass'y	CB-CS-MKS18NKU	1	8FA0518189500
10	CV6231917551	Flap		1	8522152330011	
11	CV6231772235	Drain Hose Ass'y		1	8520130329400	
12	CV6231718363	Cap, Drain Pan		1	8522234812401	
*	13	CV6233189369	Thermistor Ass'y	PTM-D51H-S4-2	1	8FA0525962800
14	CV6231510646	Screw Special	SWCH18A	4	8522239615101	
15	CV6233189352	Grille Ass'y		1	8520150194000	
*	16	CV6231772204	Step Motor	MP24Z3-12V	1	1FA4M3A000900
17	CV6233189390	Air Outlet Ass'y		1	8520153141700	
18	CV6231932363	Terminal Cover Ass'y		1	8520530907900	
*	19	CV6233189383	Fan Motor	SIC-41CVJ-D847-3	1	1FA4M5B011600
20	CV6231845489	Mounting Plate		1	8522238513001	
21	CV6231845472	Cover Plate		1	8522530941401	
*	22	CV6233187037	Remote Control Switch	PRCS-3VPSS4E-T	1	8FA0005458900
23	CV6230032996	Terminal Base	KTU15N-3J	1	4237956159	
24	CV6233003573	Holder		1	8512537707701	
25	CV6231917667	Elec. Component Box		1	8522530770911	
26	CV6231485876	Mounting Thermostat		1	8522530322401	
27	CV6231917650	Angle Terminal		1	8522530636301	
28	CV6231917643	Mounting Plate Ass'y		1	8520221718200	
29	CV6233189406	Sash ORN Ass'y		1	8520130136700	
30	CV6231917629	Mounting Plate, Fan Motor		1	8522235430711	
31	CV6231917612	Frame Ass'y		1	8520220143600	
32	CV6231917605	Mounting, Tube		1	8522236230212	
33	CV6231917698	Guide Air Defl		1	8522236019711	
34	CV6231845625	Rear Panel		1	8522223022901	
35	CV6231469104	Mounting		1	8522151452001	
36	CV6380037209	Mounting		2	8522151444002	
37	CV6231917681	Blade		2	8522151935411	
*	38	CV6231907750	P.C.B. Ass'y	IND-KRV184EH	1	8FA0517862700
39	CV6231917674	Cap		3	8522235024211	
40	CV6233189413	Mounting		1	8522151470911	

NOTE: Metal and plastic parts will be supplied basically with necessary heat insulation pads or packing. Each key number with an asterisk (*) means the recommended service parts.

ATTENTION!

To ensure correct parts supply, please let us know the following,

Part No. when you make service parts order:

CS-MKS18NKU
INDOOR UNIT

1.Part No. 2.Description 3.Q'ty 4.Volts-Hz-Ph 5.Product Mode No.

KeyNo.	Part No.	Description	Model Number	Q'ty	Reference No.
41	CV6231920513	Wire		1	8522131536101
	CV6233187631	Operation Manual		1	8526418121500

NOTE: Metal and plastic parts will be supplied basically with necessary heat insulation pads or packing. Each key number with an asterisk (*) means the recommended service parts.

CS-MKS24NKU
INDOOR UNIT

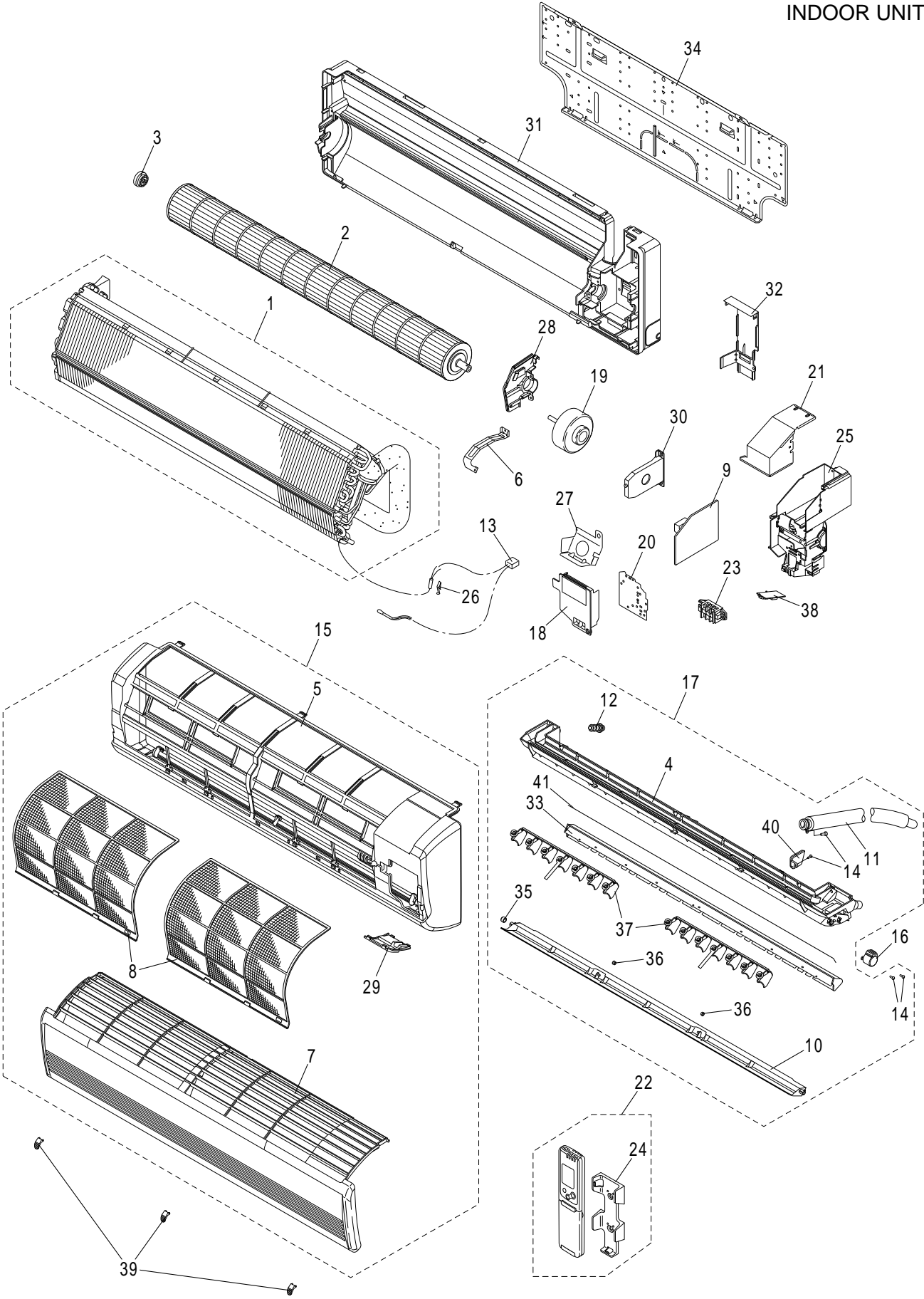

ATTENTION!

To ensure correct parts supply, please let us know the following,

Part No. when you make service parts order:

1.Part No. 2.Description 3.Q'ty 4.Volts-Hz-Ph 5.Product Mode No.

CS-MKS24NKU
INDOOR UNIT

KeyNo.	Part No.	Description	Model Number	Q'ty	Reference No.	
1	CV6231917704	Evaporator Ass'y		1	8520411693200	
*	2	CV6231845397	Cross-Flow Fan Ass'y	1	8520250929200	
*	3	CV6231718318	Bearing Housing Ass'y	1	8520251013200	
4	CV6231917520	Air Outlet Frame		1	8522153121011	
5	CV6231917513	Grille		1	8522150152211	
6	CV6231845366	Mounting Plate		1	8522238512801	
7	CV6233189345	Ornamental Plate		1	8522151638712	
8	CV6233189338	Air Filter Ass'y		2	8520230739201	
*	9	CV6233189581	Circuit Board Ass'y	CB-CS-MKS24NKU	1	8FA0518189600
10	CV6231917551	Flap		1	8522152330011	
11	CV6231772235	Drain Hose Ass'y		1	8520130329400	
12	CV6231718363	Cap, Drain Pan		1	8522234812401	
*	13	CV6233189369	Thermistor Ass'y	PTM-D51H-S4-2	1	8FA0525962800
14	CV6231510646	Screw Special	SWCH18A	4	8522239615101	
15	CV6233189352	Grille Ass'y		1	8520150194000	
*	16	CV6231772204	Step Motor	MP24Z3-12V	1	1FA4M3A000900
17	CV6233189390	Air Outlet Ass'y		1	8520153141700	
18	CV6231932363	Terminal Cover Ass'y		1	8520530907900	
*	19	CV6233189383	Fan Motor	SIC-41CVJ-D847-3	1	1FA4M5B011600
20	CV6231845489	Mounting Plate		1	8522238513001	
21	CV6231845472	Cover Plate		1	8522530941401	
*	22	CV6233187037	Remote Control Switch	PRCS-3VPSS4E-T	1	8FA0005458900
23	CV6230032996	Terminal Base	KTU15N-3J	1	4237956159	
24	CV6233003573	Holder		1	8512537707701	
25	CV6231917667	Elec. Component Box		1	8522530770911	
26	CV6231485876	Mounting Thermostat		1	8522530322401	
27	CV6231917650	Angle Terminal		1	8522530636301	
28	CV6231917643	Mounting Plate Ass'y		1	8520221718200	
29	CV6233189406	Sash ORN Ass'y		1	8520130136700	
30	CV6231917629	Mounting Plate, Fan Motor		1	8522235430711	
31	CV6231917612	Frame Ass'y		1	8520220143600	
32	CV6231917605	Mounting, Tube		1	8522236230212	
33	CV6231917698	Guide Air Defl		1	8522236019711	
34	CV6231845625	Rear Panel		1	8522223022901	
35	CV6231469104	Mounting		1	8522151452001	
36	CV6380037209	Mounting		2	8522151444002	
37	CV6231917681	Blade		2	8522151935411	
*	38	CV6231907750	P.C.B. Ass'y	IND-KRV184EH	1	8FA0517862700
39	CV6231917674	Cap		3	8522235024211	
40	CV6233189413	Mounting		1	8522151470911	

NOTE: Metal and plastic parts will be supplied basically with necessary heat insulation pads or packing. Each key number with an asterisk (*) means the recommended service parts.

ATTENTION!

To ensure correct parts supply, please let us know the following,

Part No. when you make service parts order:

CS-MKS24NKU
INDOOR UNIT

1.Part No. 2.Description 3.Q'ty 4.Volts-Hz-Ph 5.Product Mode No.

KeyNo.	Part No.	Description	Model Number	Q'ty	Reference No.
41	CV6231920513	Wire		1	8522131536101
	CV6233187631	Operation Manual		1	8526418121500

NOTE: Metal and plastic parts will be supplied basically with necessary heat insulation pads or packing. Each key number with an asterisk (*) means the recommended service parts.

CS-MKE7NKU
INDOOR UNIT

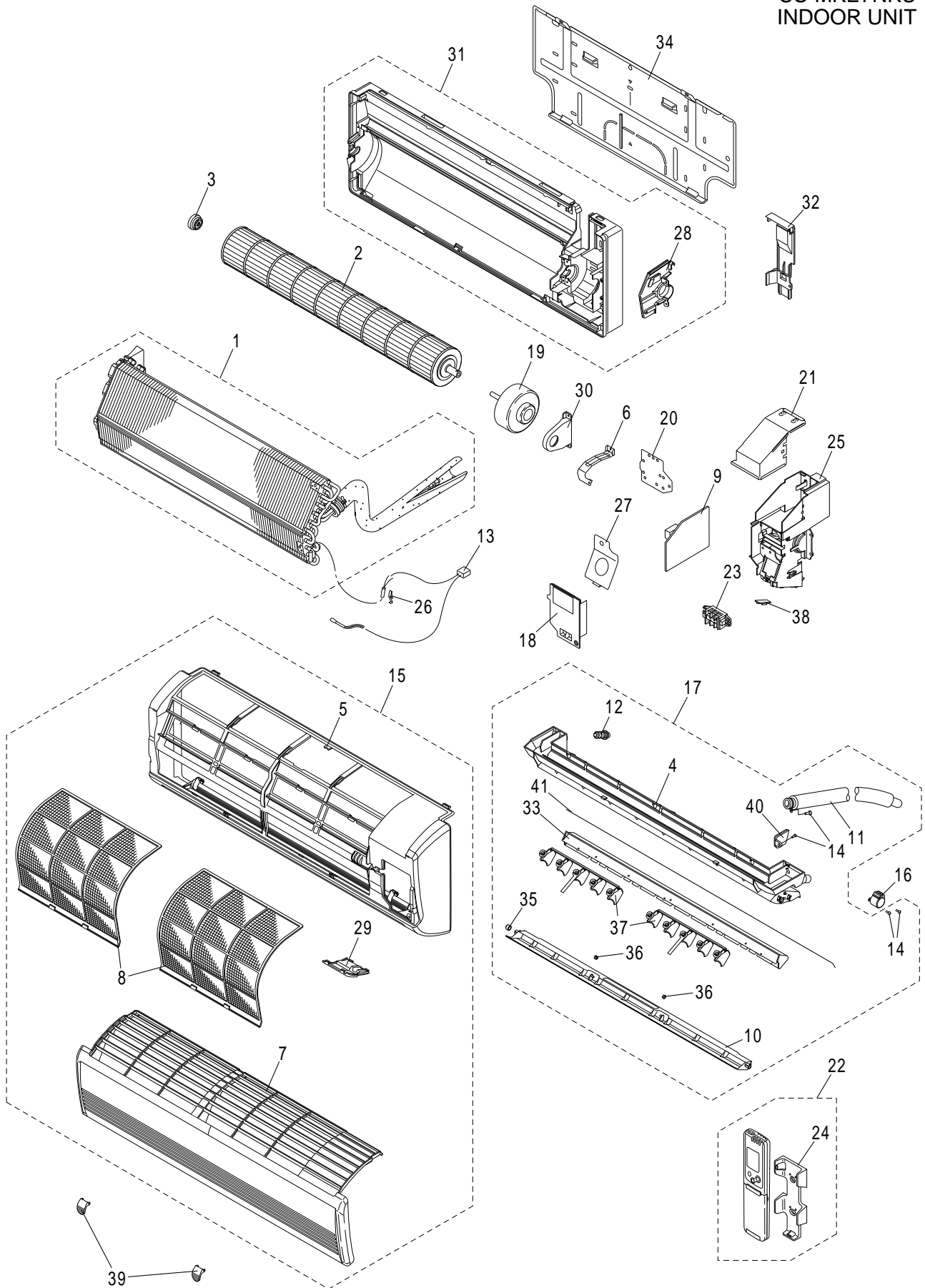

ATTENTION!

To ensure correct parts supply, please let us know the following,

Part No. when you make service parts order:

1.Part No. 2.Description 3.Q'ty 4.Volts-Hz-Ph 5.Product Mode No.

CS-MKE7NKU
INDOOR UNIT

KeyNo.	Part No.	Description	Model Number	Q'ty	Reference No.	
1	CV6231908320	Evaporator Ass'y		1	8520411692800	
*	2	CV6231847018	Cross-Flow Fan Ass'y	1	8520250929300	
*	3	CV6231718318	Bearing Housing Ass'y	1	8520251013200	
4	CV6231908313	Air Outlet Frame		1	8522153120711	
5	CV6233189475	Grille		1	8522150151011	
6	CV6231772150	Mounting Plate		1	8522230997501	
7	CV6233189468	Ornamental Plate		1	8522151638052	
8	CV6233189451	Air Filter Ass'y		2	8520230739301	
*	9	CV6233189598	Circuit Board Ass'y	CB-CS-MKE7NKU	1	8FA0518189700
10	CV6231908344	Flap		1	8522152329211	
11	CV6231772235	Drain Hose Ass'y		1	8520130329400	
12	CV6231718363	Cap, Drain Pan		1	8522234812401	
*	13	CV6233189505	Thermistor Ass'y	PTM-D51H-S4-1	1	8FA0525962900
14	CV6231510646	Screw Special	SWCH18A	4	8522239615101	
15	CV6233189499	Grille Ass'y		1	8520150194100	
*	16	CV6233189482	Step Motor K		1	8FA0526701100
17	CV6233189536	Air Outlet Ass'y		1	8520153141600	
18	CV6231932301	Terminal Cover Ass'y		1	8520530907800	
*	19	CV6233189529	Fan Motor	SIC-41CVJ-D847-4	1	1FA4M5B011700
20	CV6231908375	Mounting Plate		1	8522238514701	
21	CV6231842969	Plate, Elec. Component Box		1	8522530940901	
*	22	CV6233187020	Remote Control Switch	PRCS-3HVPSS4EE-T	1	8FA0005458800
23	CV6230032996	Terminal Base	KTU15N-3J	1	4237956159	
24	CV6233003573	Holder		1	8512537707701	
25	CV6231908467	Elec. Component Box		1	8522530770001	
26	CV6231485876	Mounting Thermostat		1	8522530322401	
27	CV6231908474	Angle Terminal		1	8522530636101	
28	CV6231908450	Mounting Plate		1	8522230978511	
29	CV6233189543	Sash ORN Ass'y		1	8520130136600	
30	CV6231932318	Mounting Plate, Fan Motor		1	8522235430211	
31	CV6231908429	Frame Ass'y		1	8520220143500	
32	CV6231908412	Mounting, Tube		1	8522236229812	
33	CV6231908511	Guide Air Defl		1	8522236019411	
34	CV6231772433	Rear Panel		1	8522223022501	
35	CV6231469104	Mounting		1	8522151452001	
36	CV6380037209	Mounting		2	8522151444002	
37	CV6231908504	Blade		2	8522151934911	
*	38	CV6231908306	P.C.B. Ass'y	IND-KHS1271	1	8FA0517855900
39	CV6231908481	Cap		2	8522235023811	
40	CV6233189413	Mounting		1	8522151470911	

NOTE: Metal and plastic parts will be supplied basically with necessary heat insulation pads or packing. Each key number with an asterisk (*) means the recommended service parts.

ATTENTION!

To ensure correct parts supply, please let us know the following,

Part No. when you make service parts order:

CS-MKE7NKU
INDOOR UNIT

1.Part No. 2.Description 3.Q'ty 4.Volts-Hz-Ph 5.Product Mode No.

KeyNo.	Part No.	Description	Model Number	Q'ty	Reference No.
41	CV6231932325	Wire	SWP-A	1	8522131536001
	CV6233187617	Operation Manual		1	8526418121700

NOTE: Metal and plastic parts will be supplied basically with necessary heat insulation pads or packing. Each key number with an asterisk (*) means the recommended service parts.

CS-MKE9NKU
INDOOR UNIT

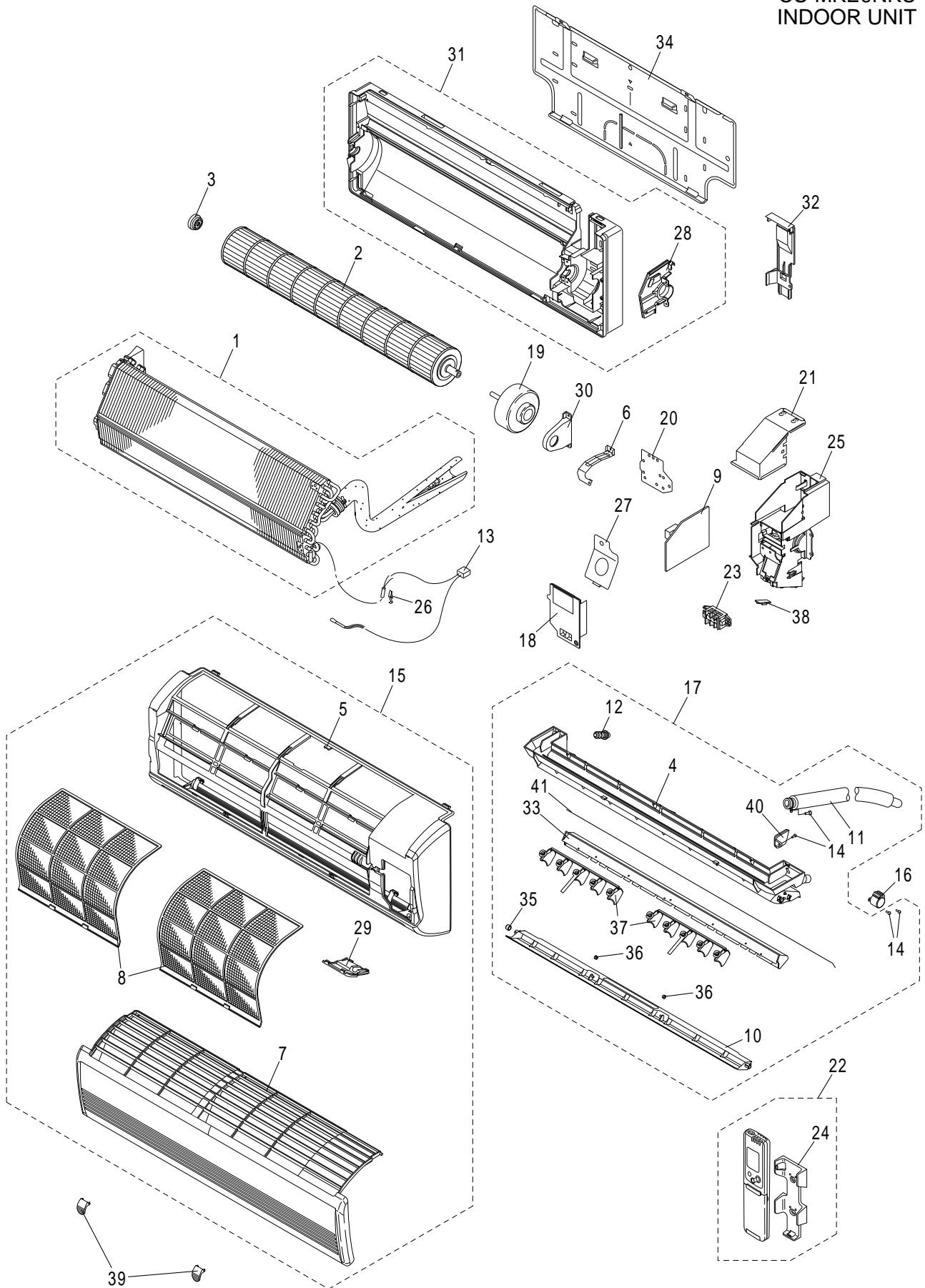

ATTENTION!

To ensure correct parts supply, please let us know the following,

Part No. when you make service parts order:

1.Part No. 2.Description 3.Q'ty 4.Volts-Hz-Ph 5.Product Mode No.

CS-MKE9NKU
INDOOR UNIT

KeyNo.	Part No.	Description	Model Number	Q'ty	Reference No.	
1	CV6231908320	Evaporator Ass'y		1	8520411692800	
*	2	CV6231847018	Cross-Flow Fan Ass'y	1	8520250929300	
*	3	CV6231718318	Bearing Housing Ass'y	1	8520251013200	
4	CV6231908313	Air Outlet Frame		1	8522153120711	
5	CV6233189475	Grille		1	8522150151011	
6	CV6231772150	Mounting Plate		1	8522230997501	
7	CV6233189468	Ornamental Plate		1	8522151638052	
8	CV6233189451	Air Filter Ass'y		2	8520230739301	
*	9	CV6233189604	Circuit Board Ass'y	CB-CS-MKE9NKU	1	8FA0518189800
10	CV6231908344	Flap		1	8522152329211	
11	CV6231772235	Drain Hose Ass'y		1	8520130329400	
12	CV6231718363	Cap, Drain Pan		1	8522234812401	
*	13	CV6233189505	Thermistor Ass'y	PTM-D51H-S4-1	1	8FA0525962900
14	CV6231510646	Screw Special	SWCH18A	4	8522239615101	
15	CV6233189499	Grille Ass'y		1	8520150194100	
*	16	CV6233189482	Step Motor K		1	8FA0526701100
17	CV6233189536	Air Outlet Ass'y		1	8520153141600	
18	CV6231932301	Terminal Cover Ass'y		1	8520530907800	
*	19	CV6233189529	Fan Motor	SIC-41CVJ-D847-4	1	1FA4M5B011700
20	CV6231908375	Mounting Plate		1	8522238514701	
21	CV6231842969	Plate, Elec. Component Box		1	8522530940901	
*	22	CV6233187020	Remote Control Switch	PRCS-3HVPSS4EE-T	1	8FA0005458800
23	CV6230032996	Terminal Base	KTU15N-3J	1	4237956159	
24	CV6233003573	Holder		1	8512537707701	
25	CV6231908467	Elec. Component Box		1	8522530770001	
26	CV6231485876	Mounting Thermostat		1	8522530322401	
27	CV6231908474	Angle Terminal		1	8522530636101	
28	CV6231908450	Mounting Plate		1	8522230978511	
29	CV6233189543	Sash ORN Ass'y		1	8520130136600	
30	CV6231932318	Mounting Plate, Fan Motor		1	8522235430211	
31	CV6231908429	Frame Ass'y		1	8520220143500	
32	CV6231908412	Mounting, Tube		1	8522236229812	
33	CV6231908511	Guide Air Defl		1	8522236019411	
34	CV6231772433	Rear Panel		1	8522223022501	
35	CV6231469104	Mounting		1	8522151452001	
36	CV6380037209	Mounting		2	8522151444002	
37	CV6231908504	Blade		2	8522151934911	
*	38	CV6231908306	P.C.B. Ass'y	IND-KHS1271	1	8FA0517855900
39	CV6231908481	Cap		2	8522235023811	
40	CV6233189413	Mounting		1	8522151470911	

NOTE: Metal and plastic parts will be supplied basically with necessary heat insulation pads or packing. Each key number with an asterisk (*) means the recommended service parts.

ATTENTION!

To ensure correct parts supply, please let us know the following,

Part No. when you make service parts order:

CS-MKE9NKU
INDOOR UNIT

1.Part No. 2.Description 3.Q'ty 4.Volts-Hz-Ph 5.Product Mode No.

KeyNo.	Part No.	Description	Model Number	Q'ty	Reference No.
41	CV6231932325	Wire	SWP-A	1	8522131536001
	CV6233187617	Operation Manual		1	8526418121700

NOTE: Metal and plastic parts will be supplied basically with necessary heat insulation pads or packing. Each key number with an asterisk (*) means the recommended service parts.

CS-MKE12NKU
INDOOR UNIT

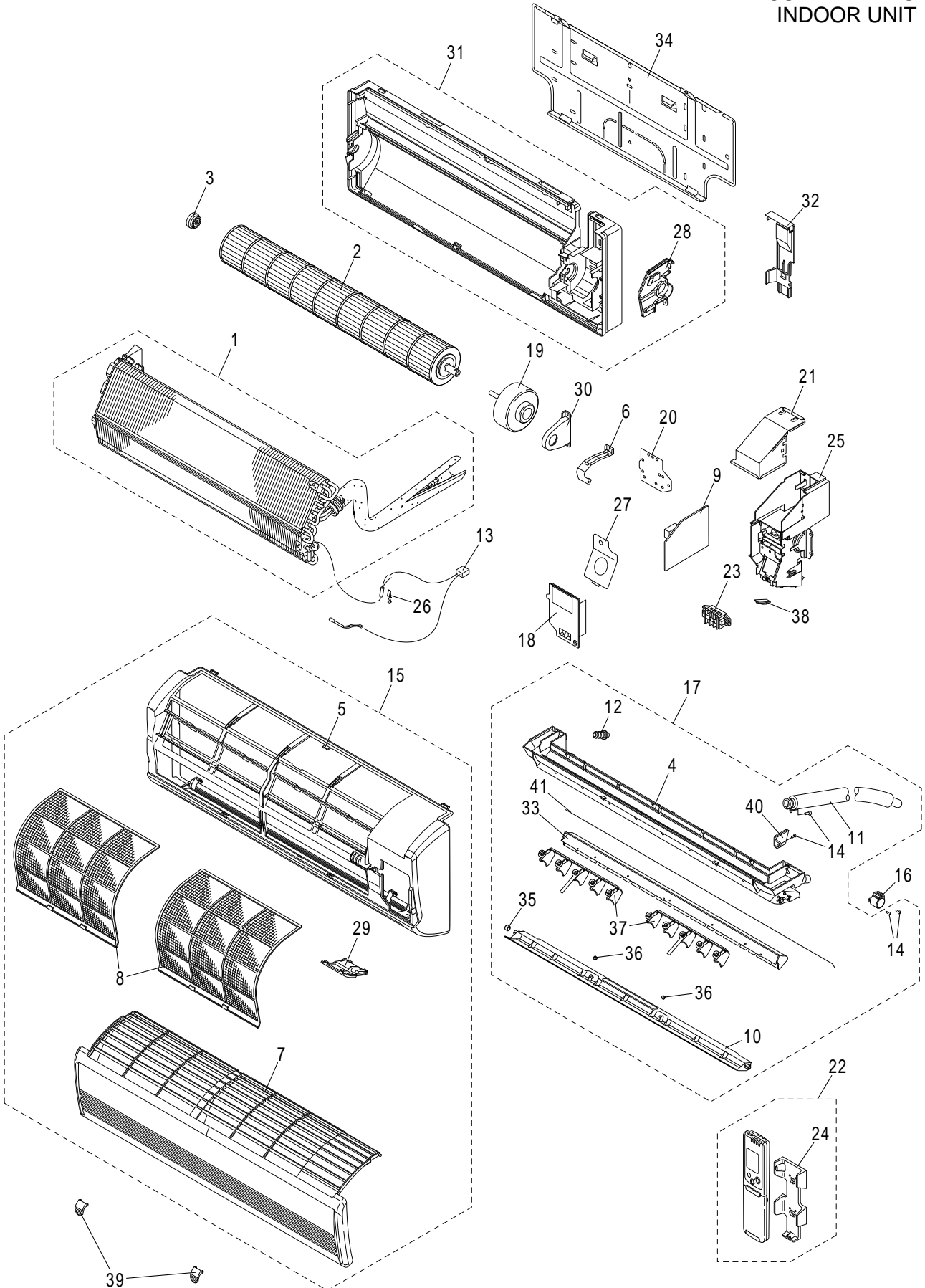

ATTENTION!

To ensure correct parts supply, please let us know the following,

Part No. when you make service parts order:

1.Part No. 2.Description 3.Q'ty 4.Volts-Hz-Ph 5.Product Mode No.

CS-MKE12NKU
INDOOR UNIT

KeyNo.	Part No.	Description	Model Number	Q'ty	Reference No.	
1	CV6231908320	Evaporator Ass'y		1	8520411692800	
*	2	CV6231847018	Cross-Flow Fan Ass'y	1	8520250929300	
*	3	CV6231718318	Bearing Housing Ass'y	1	8520251013200	
4	CV6231908313	Air Outlet Frame		1	8522153120711	
5	CV6233189475	Grille		1	8522150151011	
6	CV6231772150	Mounting Plate		1	8522230997501	
7	CV6233189468	Ornamental Plate		1	8522151638052	
8	CV6233189451	Air Filter Ass'y		2	8520230739301	
*	9	CV6233189611	Circuit Board Ass'y	CB-CS-MKE12NKU	1	8FA0518189900
10	CV6231908344	Flap		1	8522152329211	
11	CV6231772235	Drain Hose Ass'y		1	8520130329400	
12	CV6231718363	Cap, Drain Pan		1	8522234812401	
*	13	CV6233189505	Thermistor Ass'y	PTM-D51H-S4-1	1	8FA0525962900
14	CV6231510646	Screw Special	SWCH18A	4	8522239615101	
15	CV6233189499	Grille Ass'y		1	8520150194100	
*	16	CV6233189482	Step Motor K		1	8FA0526701100
17	CV6233189536	Air Outlet Ass'y		1	8520153141600	
18	CV6231932301	Terminal Cover Ass'y		1	8520530907800	
*	19	CV6233189529	Fan Motor	SIC-41CVJ-D847-4	1	1FA4M5B011700
20	CV6231908375	Mounting Plate		1	8522238514701	
21	CV6231842969	Plate, Elec. Component Box		1	8522530940901	
*	22	CV6233187020	Remote Control Switch	PRCS-3HVPSS4EE-T	1	8FA0005458800
23	CV6230032996	Terminal Base	KTU15N-3J	1	4237956159	
24	CV6233003573	Holder		1	8512537707701	
25	CV6231908467	Elec. Component Box		1	8522530770001	
26	CV6231485876	Mounting Thermostat		1	8522530322401	
27	CV6231908474	Angle Terminal		1	8522530636101	
28	CV6231908450	Mounting Plate		1	8522230978511	
29	CV6233189543	Sash ORN Ass'y		1	8520130136600	
30	CV6231932318	Mounting Plate, Fan Motor		1	8522235430211	
31	CV6231908429	Frame Ass'y		1	8520220143500	
32	CV6231908412	Mounting, Tube		1	8522236229812	
33	CV6231908511	Guide Air Defl		1	8522236019411	
34	CV6231772433	Rear Panel		1	8522223022501	
35	CV6231469104	Mounting		1	8522151452001	
36	CV6380037209	Mounting		2	8522151444002	
37	CV6231908504	Blade		2	8522151934911	
*	38	CV6231908306	P.C.B. Ass'y	IND-KHS1271	1	8FA0517855900
39	CV6231908481	Cap		2	8522235023811	
40	CV6233189413	Mounting		1	8522151470911	

NOTE: Metal and plastic parts will be supplied basically with necessary heat insulation pads or packing. Each key number with an asterisk (*) means the recommended service parts.

ATTENTION!

To ensure correct parts supply, please let us know the following,

Part No. when you make service parts order:

CS-MKE12NKU
INDOOR UNIT

1.Part No. 2.Description 3.Q'ty 4.Volts-Hz-Ph 5.Product Mode No.

KeyNo.	Part No.	Description	Model Number	Q'ty	Reference No.
41	CV6231932325	Wire	SWP-A	1	8522131536001
	CV6233187617	Operation Manual		1	8526418121700

NOTE: Metal and plastic parts will be supplied basically with necessary heat insulation pads or packing. Each key number with an asterisk (*) means the recommended service parts.

CS-MKE18NKU
INDOOR UNIT

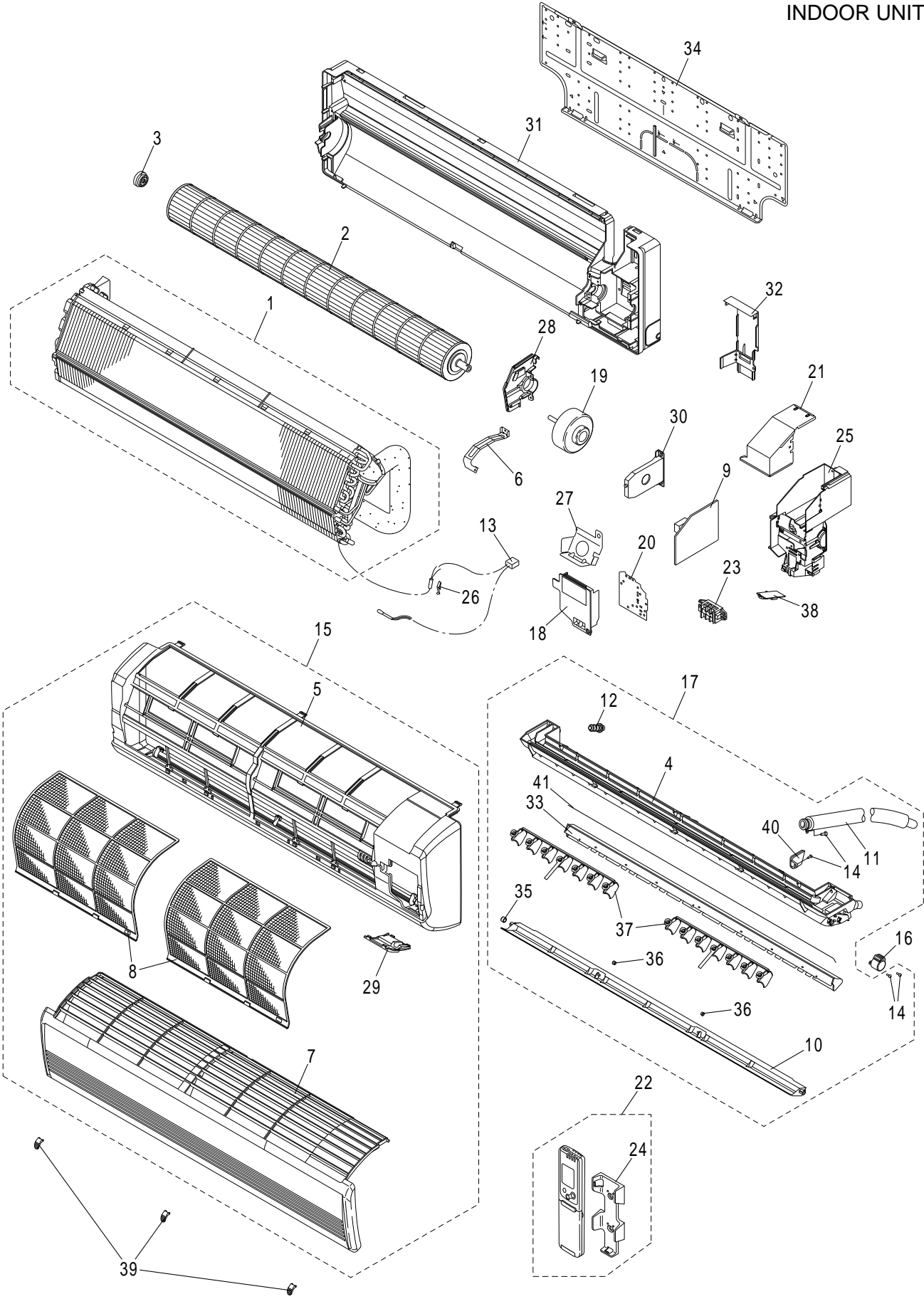

ATTENTION!

To ensure correct parts supply, please let us know the following,

Part No. when you make service parts order:

1.Part No. 2.Description 3.Q'ty 4.Volts-Hz-Ph 5.Product Mode No.

CS-MKE18NKU
INDOOR UNIT

KeyNo.	Part No.	Description	Model Number	Q'ty	Reference No.	
1	CV6231917537	Evaporator Ass'y		1	8520411693000	
*	2	CV6231845397	Cross-Flow Fan Ass'y	1	8520250929200	
*	3	CV6231718318	Bearing Housing Ass'y	1	8520251013200	
4	CV6231917520	Air Outlet Frame		1	8522153121011	
5	CV6231917513	Grille		1	8522150152211	
6	CV6231845366	Mounting Plate		1	8522238512801	
7	CV6233189345	Ornamental Plate		1	8522151638712	
8	CV6233189338	Air Filter Ass'y		2	8520230739201	
*	9	CV6233189628	Circuit Board Ass'y	CB-CS-MKE18NKU	1	8FA0518190000
10	CV6231917551	Flap		1	8522152330011	
11	CV6231772235	Drain Hose Ass'y		1	8520130329400	
12	CV6231718363	Cap, Drain Pan		1	8522234812401	
*	13	CV6233189369	Thermistor Ass'y	PTM-D51H-S4-2	1	8FA0525962800
14	CV6231510646	Screw Special	SWCH18A	4	8522239615101	
15	CV6233189352	Grille Ass'y		1	8520150194000	
*	16	CV6231772204	Step Motor	MP24Z3-12V	1	1FA4M3A000900
17	CV6233189390	Air Outlet Ass'y		1	8520153141700	
18	CV6231932363	Terminal Cover Ass'y		1	8520530907900	
*	19	CV6233189383	Fan Motor	SIC-41CVJ-D847-3	1	1FA4M5B011600
20	CV6231845489	Mounting Plate		1	8522238513001	
21	CV6231845472	Cover Plate		1	8522530941401	
*	22	CV6233187020	Remote Control Switch	PRCS-3HVPSS4EE-T	1	8FA0005458800
23	CV6230032996	Terminal Base	KTU15N-3J	1	4237956159	
24	CV6233003573	Holder		1	8512537707701	
25	CV6231917667	Elec. Component Box		1	8522530770911	
26	CV6231485876	Mounting Thermostat		1	8522530322401	
27	CV6231917650	Angle Terminal		1	8522530636301	
28	CV6231917643	Mounting Plate Ass'y		1	8520221718200	
29	CV6233189406	Sash ORN Ass'y		1	8520130136700	
30	CV6231917629	Mounting Plate, Fan Motor		1	8522235430711	
31	CV6231917612	Frame Ass'y		1	8520220143600	
32	CV6231917605	Mounting, Tube		1	8522236230212	
33	CV6231917698	Guide Air Defl		1	8522236019711	
34	CV6231845625	Rear Panel		1	8522223022901	
35	CV6231469104	Mounting		1	8522151452001	
36	CV6380037209	Mounting		2	8522151444002	
37	CV6231917681	Blade		2	8522151935411	
*	38	CV6231907750	P.C.B. Ass'y	IND-KRV184EH	1	8FA0517862700
39	CV6231917674	Cap		3	8522235024211	
40	CV6233189413	Mounting		1	8522151470911	

NOTE: Metal and plastic parts will be supplied basically with necessary heat insulation pads or packing. Each key number with an asterisk (*) means the recommended service parts.

ATTENTION!

To ensure correct parts supply, please let us know the following,

Part No. when you make service parts order:

CS-MKE18NKU
INDOOR UNIT

1.Part No. 2.Description 3.Q'ty 4.Volts-Hz-Ph 5.Product Mode No.

KeyNo.	Part No.	Description	Model Number	Q'ty	Reference No.
41	CV6231920513	Wire		1	8522131536101
	CV6233187600	Operation Manual		1	8526418121800

NOTE: Metal and plastic parts will be supplied basically with necessary heat insulation pads or packing. Each key number with an asterisk (*) means the recommended service parts.

CS-MKE24NKU
INDOOR UNIT

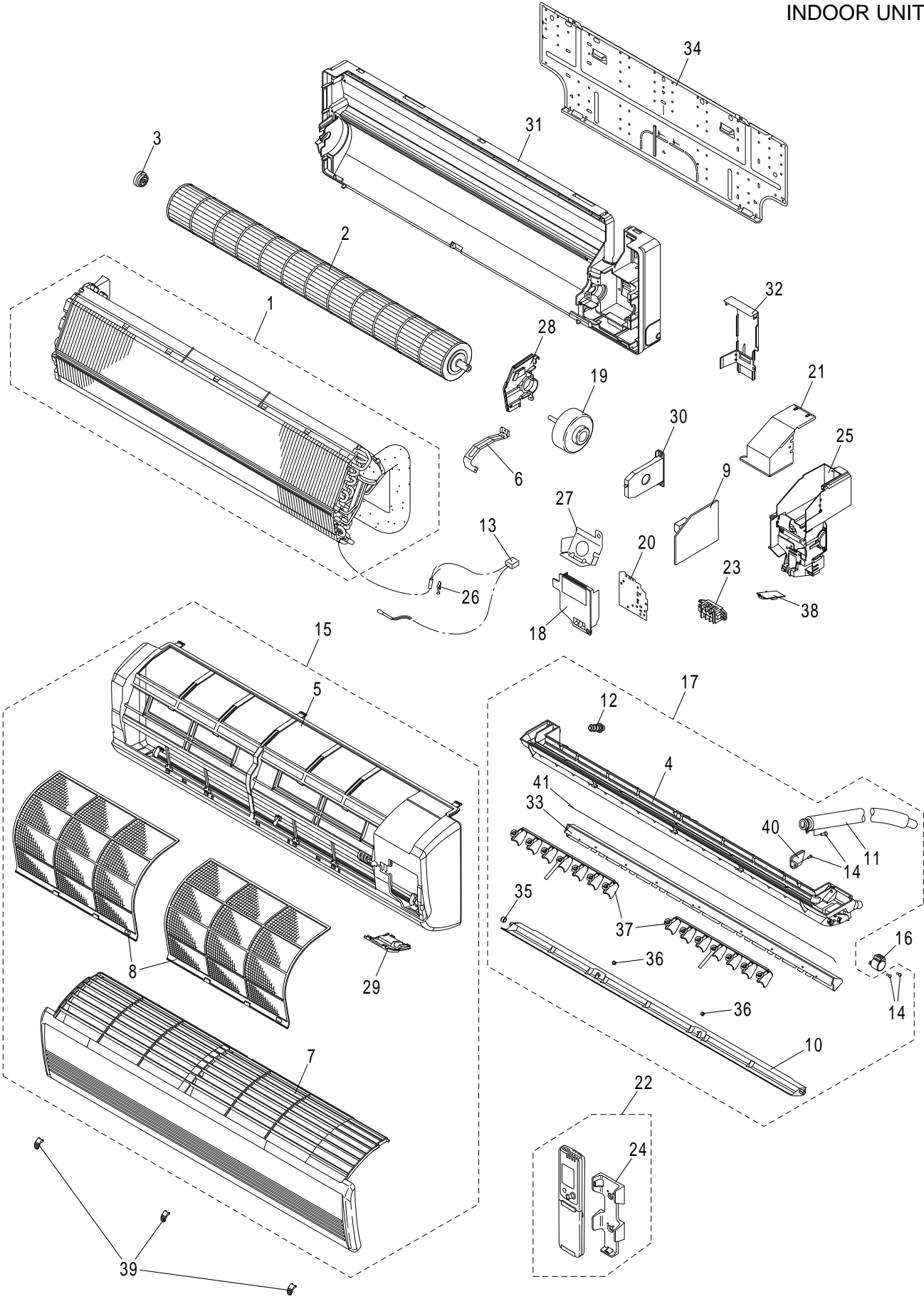

ATTENTION!

To ensure correct parts supply, please let us know the following,

Part No. when you make service parts order:

1.Part No. 2.Description 3.Q'ty 4.Volts-Hz-Ph 5.Product Mode No.

CS-MKE24NKU
INDOOR UNIT

KeyNo.	Part No.	Description	Model Number	Q'ty	Reference No.	
1	CV6231917704	Evaporator Ass'y		1	8520411693200	
*	2	CV6231845397	Cross-Flow Fan Ass'y	1	8520250929200	
*	3	CV6231718318	Bearing Housing Ass'y	1	8520251013200	
4	CV6231917520	Air Outlet Frame		1	8522153121011	
5	CV6231917513	Grille		1	8522150152211	
6	CV6231845366	Mounting Plate		1	8522238512801	
7	CV6233189345	Ornamental Plate		1	8522151638712	
8	CV6233189338	Air Filter Ass'y		2	8520230739201	
*	9	CV6233189635	Circuit Board Ass'y	CB-CS-MKE24NKU	1	8FA0518190100
10	CV6231917551	Flap		1	8522152330011	
11	CV6231772235	Drain Hose Ass'y		1	8520130329400	
12	CV6231718363	Cap, Drain Pan		1	8522234812401	
*	13	CV6233189369	Thermistor Ass'y	PTM-D51H-S4-2	1	8FA0525962800
14	CV6231510646	Screw Special	SWCH18A	4	8522239615101	
15	CV6233189352	Grille Ass'y		1	8520150194000	
*	16	CV6231772204	Step Motor	MP24Z3-12V	1	1FA4M3A000900
17	CV6233189390	Air Outlet Ass'y		1	8520153141700	
18	CV6231932363	Terminal Cover Ass'y		1	8520530907900	
*	19	CV6233189383	Fan Motor	SIC-41CVJ-D847-3	1	1FA4M5B011600
20	CV6231845489	Mounting Plate		1	8522238513001	
21	CV6231845472	Cover Plate		1	8522530941401	
*	22	CV6233187020	Remote Control Switch	PRCS-3HVPSS4EE-T	1	8FA0005458800
23	CV6230032996	Terminal Base	KTU15N-3J	1	4237956159	
24	CV6233003573	Holder		1	8512537707701	
25	CV6231917667	Elec. Component Box		1	8522530770911	
26	CV6231485876	Mounting Thermostat		1	8522530322401	
27	CV6231917650	Angle Terminal		1	8522530636301	
28	CV6231917643	Mounting Plate Ass'y		1	8520221718200	
29	CV6233189406	Sash ORN Ass'y		1	8520130136700	
30	CV6231917629	Mounting Plate, Fan Motor		1	8522235430711	
31	CV6231917612	Frame Ass'y		1	8520220143600	
32	CV6231917605	Mounting, Tube		1	8522236230212	
33	CV6231917698	Guide Air Defl		1	8522236019711	
34	CV6231845625	Rear Panel		1	8522223022901	
35	CV6231469104	Mounting		1	8522151452001	
36	CV6380037209	Mounting		2	8522151444002	
37	CV6231917681	Blade		2	8522151935411	
*	38	CV6231907750	P.C.B. Ass'y	IND-KRV184EH	1	8FA0517862700
39	CV6231917674	Cap		3	8522235024211	
40	CV6233189413	Mounting		1	8522151470911	

NOTE: Metal and plastic parts will be supplied basically with necessary heat insulation pads or packing. Each key number with an asterisk (*) means the recommended service parts.

ATTENTION!

To ensure correct parts supply, please let us know the following,

Part No. when you make service parts order:

CS-MKE24NKU
INDOOR UNIT

1.Part No. 2.Description 3.Q'ty 4.Volts-Hz-Ph 5.Product Mode No.

KeyNo.	Part No.	Description	Model Number	Q'ty	Reference No.
41	CV6231920513	Wire		1	8522131536101
	CV6233187600	Operation Manual		1	8526418121800

NOTE: Metal and plastic parts will be supplied basically with necessary heat insulation pads or packing. Each key number with an asterisk (*) means the recommended service parts.