

FasNSeal® & FasNSeal® W2

**Single-wall and double-wall
special gas vent systems.**

UL 1738 and ULC S636.

FasNSeal® Flex

**Flexible chimney liner for
special gas vent system.**

UL 1738 and UL 1777.



Specifications

Applications

FasNSeal and FasNSeal Flex is for use with natural gas or propane Categories II, III and IV appliances or Canada's Type BH Gas Vent Systems, having a maximum rated operating temperature of 480°F and a maximum positive pressure of 15" (FasNSeal Flex 6") water column. FasNSeal can be used on a wide range of applications, including: high efficiency gas boilers, furnaces, booster heaters, pool heaters, water heaters, unit heaters, or tankless water heaters.

FasNSeal W2 is ideal for use on commercial applications such as: office buildings, medical facilities, condos, or multiple unit apartment complexes where there is the need for low clearances to combustibles. In residential applications, FasNSeal W2 is the perfect solution for running between floor joists or in walls.

Materials and Construction

FasNSeal

3"-7": AL29-4C .016"
8"-12": AL29-4C .019"
14"-24": AL29-4C .024"

FasNSeal Flex

Single strip double layer super-ferritic stainless steel (totalling .010").

FasNSeal W2

3"-6": AL29-4C stainless steel .016" inner wall, 304 or 430 .016" outer wall.
7": AL29-4C stainless steel .016" inner wall, 304 or 430 .024" outer wall.
8"-12": AL29-4C stainless steel .019" inner wall, 304 or 430 .024" outer wall.
14"-24": AL29-4C stainless steel .024" inner wall, 304 or 430 .024" outer wall.

Diameters

FasNSeal (single- and double-wall)

3"-24"

FasNSeal Flex 3"-12"

Listings

FasNSeal (single- and double-wall)

UL Listed to UL 1738 and ULC S636.

FasNSeal Flex UL Listed to UL 1738 and UL 1777 and ULC S636.

UL 1738 and ULC S636 Systems

FasNSeal & FasNSeal W2

All FasNSeal (single-wall) and FasNSeal W2 (double-wall) vent lengths and components feature patented built-in mechanical locking band and triple-lipped directional gaskets. All pipes and components are engineered with smooth clean welds located 90° from mechanical locking bands. This construction feature allows for ease of installation. The ½" air space between the inner and outer wall on FasNSeal W2 helps to reduce the clearance to combustibles in addition to creating a heat shield for additional safety.

All FasNSeal components which come in contact with exhaust gases and condensates are now silicone free. This important design and manufacturing feature greatly reduces the chances of system breakdown and failure. The main problems with silicone are there are too many adhesion factors which are very difficult to control and the process of binding similar materials with an epoxy, which can weaken the bond over time. Welded seams ensure a leak-free product that is meant to last.

FasNSeal Flex

Made from super-ferritic stainless steel. Corrosion resistant.

Manufactured with a sure-seal locking seam for superior strength and flexibility. The smooth inner-wall provides for no output reduction, allowing for full appliance efficiency, ease of cleaning and regular maintenance. The smooth inner wall optimizes gas flow, minimizes back pressure, and facilitates condensate management. Only flexible chimney liner listed to UL 1738 standard.



Typical Installations

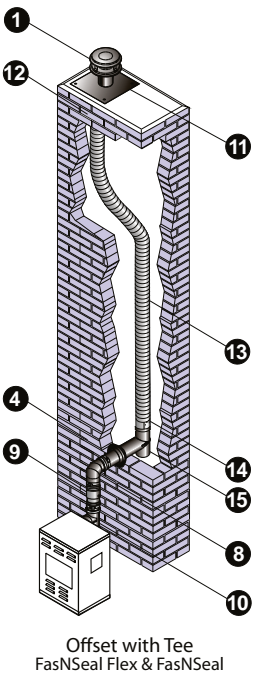
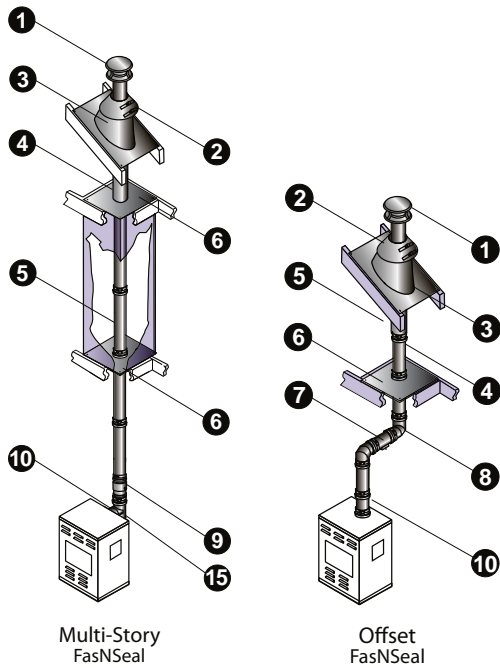

Installation Key			
1	Rain Cap	9	Universal Condensate Drain
2	Storm Collar	10	Appliance Adapter
3	Variable Pitch Roof Flashing	11	Top Plate*
4	Vent Length	12	Male Flex Adapter
5	Adjustable Vent Length	13	FasNSeal Flex
6	Firestop/Flat Flashing	14	Female Flex Adapter
7	Horizontal Drip Tee	15	Standard Tee
8	Elbow		

Refer to our Typical Venting Installation drawings to select the appropriate component parts for your installation.

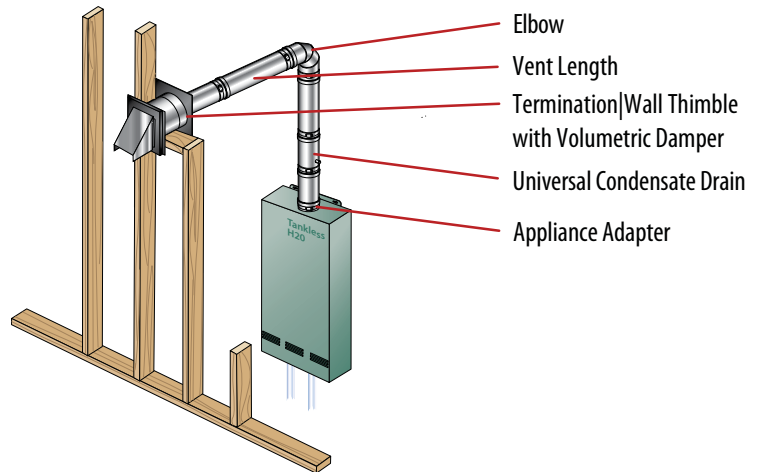

Commercial Applications

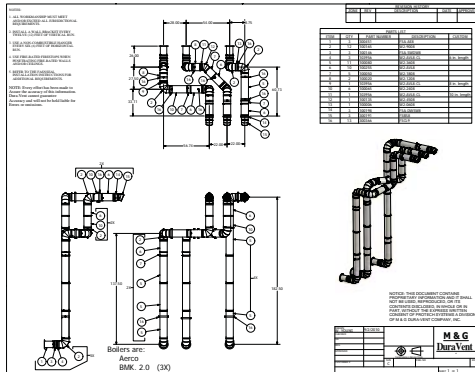

Commercial projects may require custom parts and unique system designs. DuraVent offers complete project assistance:

- **Engineering Services:** Personalized system design services offer comprehensive CAD submittal drawing and complete bills of materials.
- **Custom Parts:** If your project requires innovative solutions, contact DuraVent for custom parts that meet your specific project needs.
- **FasNSeal W2:** FasNSeal W2 is the ideal choice for commercial applications where there is a need for low clearances to combustibles.
- **Up to 24" Vent Diameters:** Many commercial applications require large diameter systems due to the units size and output. Large diameters are available in single and double wall, featuring FasNSeal's triple lipped directional gaskets and built-in locking band which provides a safe and convenient installation.

Clearances Chart

FasNSeal					
Rated Operating Temperatures		Enclosed		Unenclosed	
		Horizontal	Vertical	Horizontal	Vertical
3" - 4"	300°F 149°C	Sides: 8"/203.2mm Top: 12"/304.8mm Bottom: 4"/101.6mm	4" 101.6mm	1" 25.4mm	
	480°F 249°C			3" 76.2mm	1" 25.4mm
5" - 24"	300°F 149°C	Noncombustible Enclosure		3" 76.2mm	3" 76.2mm
	480°F 249°C			3" 76.2mm	3" 76.2mm
FasNSeal W2					
Rated Operating Temperatures		Enclosed		Unenclosed	
		Horizontal	Vertical	Horizontal	Vertical
3" - 4"	300°F	3"	1"	1"	1"
	400°F	6"	1"	3"	1"
	480°F	6"	4"	3"	1"
5" - 16"	300°F	3"	1"	1"	1"
	400°F	6"	1"	3"	1"
	480°F	6"	6"	3"	3"
Rated Operating Temperature of 300°F = Max Flue Gas Temperature of 375°F					
Rated Operating Temperature of 480°F = Max Flue Gas Temperature of 550°F					

FasNSeal® - Single-Wall

Vent Length

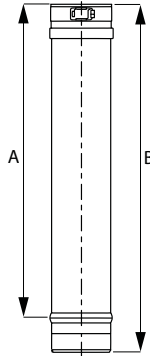

Use to vent category II, III and IV appliances.

SIZE	ORDER #	STOCK #	A	B	SIZE	ORDER #	STOCK #	A	B
3"	FSVL603	810003091	4"	6"	10"	FSVL2410	810003429	22"	24"
3"	FSVL1203	810003092	10"	12"	10"	FSVL3610	810003430	34"	36"
3"	FSVL1803	810003093	16"	18"	12"	FSVL612	810003467	4"	6"
3"	FSVL2403	810003094	22"	24"	12"	FSVL1212	810003468	10"	12"
3"	FSVL3603	810003095	34"	36"	12"	FSVL1812	810003469	16"	18"
4"	FSVL604	810003142	4"	6"	12"	FSVL2412	810003470	22"	24"
4"	FSVL1204	810003143	10"	12"	12"	FSVL3612	810003471	34"	36"
4"	FSVL1804	810003144	16"	18"	14"	FSVL614	810003508	4"	6"
4"	FSVL2404	810003145	22"	24"	14"	FSVL1214	810003509	10"	12"
4"	FSVL3604	810003146	34"	36"	14"	FSVL1814	810003510	16"	18"
5"	FSVL605	810003200	4"	6"	14"	FSVL2414	810003511	22"	24"
5"	FSVL1205	810003201	10"	12"	14"	FSVL3614	810003512	34"	36"
5"	FSVL1805	810003202	16"	18"	16"	FSVL616	810003543	4"	6"
5"	FSVL2405	810003203	22"	24"	16"	FSVL1216	810003544	10"	12"
5"	FSVL3605	810003204	34"	36"	16"	FSVL1816	810003545	16"	18"
6"	FSVL606	810003255	4"	6"	16"	FSVL2416	810003546	22"	24"
6"	FSVL1206	810003256	10"	12"	16"	FSVL3616	810003547	34"	36"
6"	FSVL1806	810003257	16"	18"	18"	FSVL618	810003577	4"	6"
6"	FSVL2406	810003258	22"	24"	18"	FSVL1218	810003578	10"	12"
6"	FSVL3606	810003259	34"	36"	18"	FSVL1818	810003579	16"	18"
7"	FSVL607	810003301	4"	6"	18"	FSVL2418	810003580	22"	24"
7"	FSVL1207	810003302	10"	12"	18"	FSVL3618	810003581	34"	36"
7"	FSVL1807	810003303	16"	18"	20"	FSVL620	810003597	4"	6"
7"	FSVL2407	810003304	22"	24"	20"	FSVL1220	810003598	10"	12"
7"	FSVL3607	810003305	34"	36"	20"	FSVL1820	810003599	16"	18"
8"	FSVL608	810003343	4"	6"	20"	FSVL2420	810003600	22"	24"
8"	FSVL1208	810003344	10"	12"	20"	FSVL3620	810003601	34"	36"
8"	FSVL1808	810003345	16"	18"	22"	FSVL622	810003617	4"	6"
8"	FSVL2408	810003346	22"	24"	22"	FSVL1222	810003618	10"	12"
8"	FSVL3608	810003347	34"	36"	22"	FSVL1822	810003619	16"	18"
9"	FSVL609	810003388	4"	6"	22"	FSVL2422	810003620	22"	24"
9"	FSVL1209	810003389	10"	12"	22"	FSVL3622	810003621	34"	36"
9"	FSVL1809	810003390	16"	18"	24"	FSVL624	810003636	4"	6"
9"	FSVL2409	810003391	22"	24"	24"	FSVL1224	810003637	10"	12"
9"	FSVL3609	810003392	34"	36"	24"	FSVL1824	810003638	16"	18"
10"	FSVL610	810003426	4"	6"	24"	FSVL2424	810003639	22"	24"
10"	FSVL1210	810003427	10"	12"	24"	FSVL3624	810003640	34"	36"
10"	FSVL1810	810003428	16"	18"					

Adjustable Vent Length

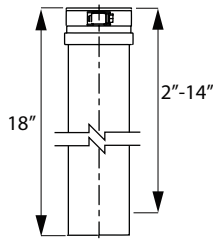

Use to add length to straight length of FasNSeal pipe. Adds 2"-14" of length. Requires at least 4" overlap for a secure connection.
Available in Custom Lengths.

SIZE	ORDER #	STOCK #	SIZE	ORDER #	STOCK #
3"	FSAVL3	810003097	12"	FSAVL12	810003472
4"	FSAVL4	810003148	14"	FSAVL14	810003513
5"	FSAVL5	810003205	16"	FSAVL16	810003548
6"	FSAVL6	810003260	18"	FSAVL18	810003582
7"	FSAVL7	810003306	20"	FSAVL20	810003602
8"	FSAVL8	810003348	22"	FSAVL22	810003622
9"	FSAVL9	810003393	24"	FSAVL24	810003641
10"	FSAVL10	810003431			

2° Adjustable Vent Length

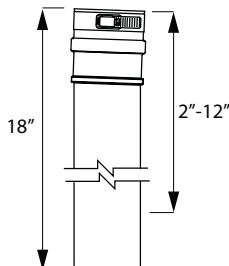

Use to facilitate for the 2° pitched required in horizontal runs.
Available in Custom Lengths.

SIZE	ORDER #	STOCK #	SIZE	ORDER #	STOCK #
3"	FSAVL03-2	810003099	9"	FSAVL09-2	810003395
4"	FSAVL04-2	810003150	10"	FSAVL10-2	810003433
5"	FSAVL05-2	810003207	12"	FSAVL12-2	810003474
6"	FSAVL06-2	810003262	14"	FSAVL14-2	810003515
7"	FSAVL07-2	810003308	16"	FSAVL16-2	810003550
8"	FSAVL08-2	810003350			

FasNSeal Flex



Use to vent Category II, III and IV gas burning appliances. Listed to UL 1738. Can only be used in vertical or near vertical runs.

Custom lengths are available for 3"-12" diameters. Minimum length of 10' for custom orders. Maximum length of 50' for 9" diameter custom orders and 25' for 10" and 12" diameter custom orders. Use with FasNSeal components only.

SIZE	20'		25'		30'		35'	
	Order #	Stock #	Order #	Stock #	Order #	Stock #	Order #	Stock #
3"	3FSFLEX-20	810003100	3FSFLEX-25	810003101	3FSFLEX-30	810003102	3FSFLEX-35	810003103
4"	4FSFLEX-20	810003151	4FSFLEX-25	810003152	4FSFLEX-30	810003153	4FSFLEX-35	810003154
5"	5FSFLEX-20	810003208	5FSFLEX-25	810003209	5FSFLEX-30	810003210	5FSFLEX-35	810003211
6"	6FSFLEX-20	810003263	6FSFLEX-25	810003264	6FSFLEX-30	810003265	6FSFLEX-35	810003266
7"	7FSFLEX-20	810003309	7FSFLEX-25	810003310	7FSFLEX-30	810003311	7FSFLEX-35	810003312
8"	8FSFLEX-20	810003351	8FSFLEX-25	810003352	8FSFLEX-30	810003353	8FSFLEX-35	810003354
SIZE	50'		100'		125'		200'	
	Order #	Stock #	Order #	Stock #	Order #	Stock #	Order #	Stock #
3"	--	--	--	--	--	--	3FSFLEX-200	810003104
4"	--	--	--	--	--	--	4FSFLEX-200	810003155
5"	--	--	--	--	5FSFLEX-125	810003212	--	--
6"	--	--	6FSFLEX-100	810003267	--	--	--	--
8"	8FSFLEX-50	810003355	--	--	--	--	--	--
SIZE	CUSTOM		SIZE	CUSTOM				
	ORDER #	STOCK #		ORDER #	STOCK #			
3"	3FSFLEX-XX	810003105	8"	8FSFLEX-XX	810003356			
4"	4FSFLEX-XX	810003156	9"	9FSFLEX-XX	810003396			
5"	5FSFLEX-XX	810003213	10"	10FSFLEX-XX	810003434			
6"	6FSFLEX-XX	810003268	12"	12FSFLEX-XX	810003475			
7"	7FSFLEX-XX	810003314						

Male Flex Adapter

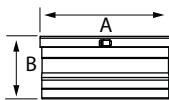

Use to connect FasNSeal rigid Vent Pipe to FasNSeal Flex at base of masonry chimney or bottom termination.

SIZE	ORDER #	STOCK #	A	B	SIZE	ORDER #	STOCK #	A	B
3"	FSASMM-3	810003140	2 4/8"	3 1/8"	8"	FSASMM-8	810003386	7 4/8"	8 1/8"
4"	FSASMM-4	810003198	3 4/8"	4 1/8"	9"	FSASMM-9	810003424	8 4/8"	9 1/8"
5"	FSASMM-5	810003247	4 4/8"	5 1/8"	10"	FSASMM-10	810003465	9 4/8"	10 1/8"
6"	FSASMM-6	810003299	5 4/8"	6 1/8"	12"	FSASMM-12	810003506	11 4/8"	12 1/8"
7"	FSASMM-7	810003341	6 4/8"	7 1/8"					

Female Flex Adapter

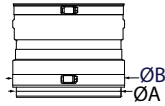

Use to connect FasNSeal Flex to FasNSeal rigid Vent Pipe at the top of the system.

SIZE	ORDER #	STOCK #	A	B	SIZE	ORDER #	STOCK #	A	B
3"	FSASMF-3	810003141	2 4/5"	3 1/5"	8"	FSASMF-8	810003387	7 4/5"	8 1/5"
4"	FSASMF-4	810003199	3 1/5"	4 1/5"	9"	FSASMF-9	810003425	8 4/5"	9 1/5"
5"	FSASMF-5	810003248	4 4/5"	5 1/5"	10"	FSASMF-10	810003466	9 4/5"	10 1/5"
6"	FSASMF-6	810003300	5 4/5"	6 1/5"	12"	FSASMF-12	810003507	11 4/5"	12 1/5"
7"	FSASMF-7	810003342	6 4/5"	7 1/5"					

Test Port

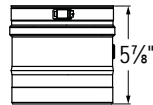

Use to test for proper appliance operation without penetrating the vent wall. Easy access to perform flue gas analysis. More options available, see Universal Adapter w/Test Port in FasNSeal Appliance Adapter section.

SIZE	ORDER #	STOCK #	SIZE	ORDER #	STOCK #
3"	FSTP3	810003135	9"	FSTP9	810003422
4"	FSTP4	810003196	10"	FSTP10	810003463
5"	FSTP5	810003245	12"	FSTP12	810003504
6"	FSTP6	810003297	14"	FSTP14	810003541
7"	FSTP7	810003339	16"	FSTP16	810003575
8"	FSTP8	810003384			

90° Elbow

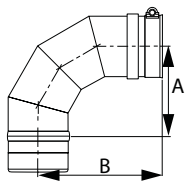

Use to go from horizontal to vertical runs or vertical to horizontal runs. Use to turn vent 90°.

SIZE	ORDER #	STOCK #	A	B	SIZE	ORDER #	STOCK #	A	B
3"	FSELB9003	810003106	4"	6"	12"	FSELB9012	810003476	8 1/2"	10 1/4"
4"	FSELB9004	810003157	4 1/2"	6 1/4"	14"	FSELB9014	810003516	9 1/2"	11 3/8"
5"	FSELB9005	810003214	5"	6 3/4"	16"	FSELB9016	810003551	11"	12 1/2"
6"	FSELB9006	810003269	5 1/2"	7 1/2"	18"	FSELB9018	810003583	11 1/2"	13 3/8"
7"	FSELB9007	810003315	6 1/8"	7 7/8"	20"	FSELB9020	810003603	12 1/2"	14 1/2"
8"	FSELB9008	810003357	6 1/2"	8 1/4"	22"	FSELB9022	810003623	13 3/8"	15"
9"	FSELB9009	810003397	7"	9"	24"	FSELB9024	810003642	14 1/2"	16 1/8"
10"	FSELB9010	810003435	7 1/2"	9 3/8"					

88° Elbow

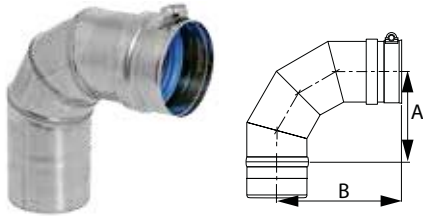

Use to transition from a vertical to a horizontal run. Stabilizes a 2° pitch towards the condensate drain for good condensate management.

SIZE	ORDER #	STOCK #	A	B	SIZE	ORDER #	STOCK #	A	B
3"	FSELB8803	810003107	4"	6"	9"	FSELB8809	810003398	7"	9"
4"	FSELB8804	810003158	4 1/2"	6 1/4"	10"	FSELB8810	810003436	7 1/2"	9 3/8"
5"	FSELB8805	810003215	5"	6 3/4"	12"	FSELB8812	810003477	8 1/2"	10 1/4"
6"	FSELB8806	810003270	5 1/2"	7 1/2"	14"	FSELB8814	810003517	9 1/2"	11 3/8"
7"	FSELB8807	810003316	6 1/8"	7 7/8"	16"	FSELB8816	810003552	11"	12 1/2"
8"	FSELB8808	810003358	6 1/2"	8 1/4"					

45° Elbow

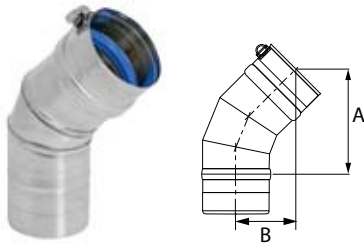

Offsets obstructions as needed. Allows for better condensate management and less back pressure.

SIZE	ORDER #	STOCK #	A	B	SIZE	ORDER #	STOCK #	A	B
3"	FSELB4503	810003108	5 3/8"	3"	12"	FSELB4512	810003478	8 1/2"	4 1/4"
4"	FSELB4504	810003159	5 5/8"	3 1/8"	14"	FSELB4514	810003518	9 1/4"	4 5/8"
5"	FSELB4505	810003216	6"	3 1/4"	16"	FSELB4516	810003553	10"	4 7/8"
6"	FSELB4506	810003271	6 3/8"	3 3/8"	18"	FSELB4518	810003585	10 1/8"	5"
7"	FSELB4507	810003317	6 3/4"	3 1/2"	20"	FSELB4520	810003605	10 7/8"	5 1/4"
8"	FSELB4508	810003359	7 1/8"	3 5/8"	22"	FSELB4522	810003625	11 5/8"	5 5/8"
9"	FSELB4509	810003399	7 1/2"	3 7/8"	24"	FSELB4524	810003644	12 3/8"	5 7/8"
10"	FSELB4510	810003437	7 7/8"	4"					

30° Elbow

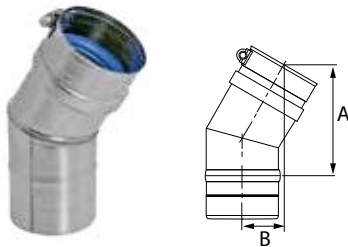

Offsets obstructions as needed. Allows for better condensate management and less back pressure.

SIZE	ORDER #	STOCK #	A	B	SIZE	ORDER #	STOCK #	A	B
3"	FSELB3003	810003109	4 7/8"	1 7/8"	9"	FSELB3009	810003400	7"	2 1/2"
4"	FSELB3004	810003160	5 1/8"	1 7/8"	10"	FSELB3010	810003438	6 1/2"	2 1/4"
5"	FSELB3005	810003217	5 1/4"	2"	12"	FSELB3012	810003479	7"	2 1/2"
6"	FSELB3006	810003272	5 1/2"	2"	14"	FSELB3014	810003519	7 1/2"	2 1/2"
7"	FSELB3007	810003318	5 7/8"	2"	16"	FSELB3016	810003554	8 1/8"	2 3/4"
8"	FSELB3008	810003360	6 1/8"	2 1/8"					

15° Elbow

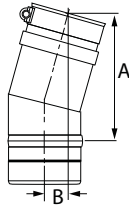

Offsets obstructions as needed. Allows for better condensate management and less back pressure.

SIZE	ORDER #	STOCK #	A	B	SIZE	ORDER #	STOCK #	A	B
3"	FSELB1503	810003110	4 3/8"	7/8"	9"	FSELB1509	810003401	5 1/4"	1"
4"	FSELB1504	810003161	4 1/2"	1"	10"	FSELB1510	810003439	5 1/4"	1"
5"	FSELB1505	810003218	4 5/8"	7/8"	12"	FSELB1512	810003480	5 1/2"	1"
6"	FSELB1506	810003273	4 3/4"	7/8"	14"	FSELB1514	810003520	5 3/4"	1"
7"	FSELB1507	810003319	4 7/8"	1"	16"	FSELB1516	810003555	6 1/8"	1"
8"	FSELB1508	810003361	5 1/8"	1"					

Wide Mouth Boot Tee

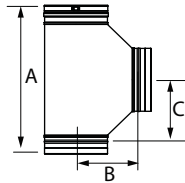

Use to transition from horizontal to vertical. Provides improved flue gas flow with angled gradual transitions. Can also be used as a manifold connection to gang boilers into a common vent.

SIZE	ORDER #	STOCK #	A	B	C
4"	FSWBT4	810003164	15 3/4"	7"	6 9/10"
5"	FSWBT5	810003220	16 3/4"	7 1/2"	7 3/10"
6"	FSWBT6	810003275	17 3/4"	8"	7 9/10"
7"	FSWBT7	810003321	18 3/4"	8 1/2"	8 3/10"
8"	FSWBT8	810003363	19 3/4"	9"	8 9/10"
9"	FSWBT9	810003403	20 3/4"	9 1/2"	9 3/10"
10"	FSWBT10	810003441	21 3/4"	10"	9 9/10"
12"	FSWBT12	810003482	23 3/4"	11"	10 9/10"
14"	FSWBT14	810003522	25 3/4"	12"	11 9/10"
16"	FSWBT16	810003557	27 3/4"	13"	12 9/10"
18"	FSWBT18	810003587	29 3/4"	14"	13 9/10"
20"	FSWBT20	810003607	31 3/4"	15"	14 9/10"
22"	FSWBT22	810003627	33 3/4"	16"	15 9/10"
24"	FSWBT24	810003646	35 3/4"	17"	16 9/10"

Standard Tee

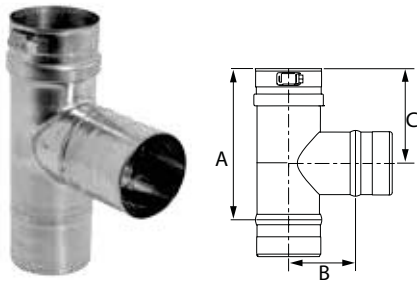

Use for a 90° offset, or to combine connections from two or more appliances into a common vent. Can also use as a condensate management point when used in conjunction with drain fitting. All Standard Tees are completely welded.

SIZE	ORDER #	STOCK #	A	B	C	SIZE	ORDER #	STOCK #	A	B	C
3"	FST3	810003111	7"	3"	4 1/2"	12"	FST12	810003481	16"	7"	9"
4"	FST4	810003162	8"	3 1/2"	5"	14"	FST14	810003521	20"	8 1/2"	11"
5"	FST5	810003219	10"	4"	6"	16"	FST16	810003556	22"	9 1/2"	12"
6"	FST6	810003274	10"	4 1/2"	6"	18"	FST18	810003586	22 7/8"	11"	12 1/2"
7"	FST7	810003320	12"	5"	7"	20"	FST20	810003606	24 7/8"	12"	13 1/2"
8"	FST8	810003362	14"	5 1/2"	8"	22"	FST22	810003626	26 7/8"	13"	14 1/2"
9"	FST9	810003402	14"	6"	8"	24"	FST24	810003645	28 7/8"	14"	15 1/2"
10"	FST10	810003440	14"	6 1/2"	8"						

Branch Tee

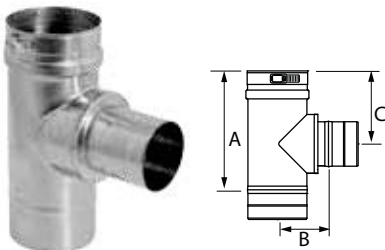

Use as a Tee increaser or as a manifold connection to gang boilers into a common vent. Available in custom size combinations.

SIZE	ORDER #	STOCK #	A	B	C
4" x 4" x 3"	FST04B03	810003112	8 1/10"	3 1/2"	5"
5" x 5" x 3"	FST05B03	810003113	8 1/10"	4"	5 3/5"
6" x 6" x 5"	FST06B05	810003222	10 1/5"	4 1/2"	5 3/4"

Boot Tee

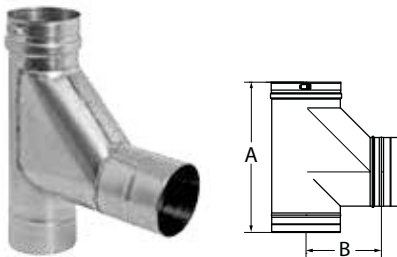

Use to transition from horizontal to vertical with improved flue gas flow.

SIZE	ORDER #	STOCK #	A	B	SIZE	ORDER #	STOCK #	A	B
4"	FSBT4	810003164	11 1/2"	7 1/2"	9"	FSBT9	810003404	16 1/2"	10"
5"	FSBT5	810003221	12 1/2"	8"	10"	FSBT10	810003442	17 1/2"	10 1/2"
6"	FSBT6	810003276	13 1/2"	8 1/2"	12"	FSBT12	810003483	19 1/2"	11 1/2"
7"	FSBT7	810003322	14 1/2"	9"	14"	FSBT14	810003523	21 1/2"	12 1/2"
8"	FSBT8	810003364	15 1/2"	9 1/2"	16"	FSBT16	810003558	23 1/2"	13 1/2"

Single-Wall Wye

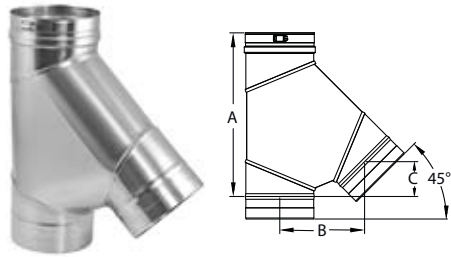

Use in place of any M&G DuraVent tee for a 45° angle instead of 90°; can be used as a manifold connection to gang multiple boilers into a common vent.

SIZE	ORDER #	STOCK #	A	B	C
6"	FSWYE06	810005506	14 1/2"	7 1/2"	3 1/10"
7"	FSWYE07	810007017	16 1/3"	8 3/5"	3 1/2"
8"	FSWYE08	810005507	18"	9 7/10"	4"
9"	FSWYE09	810005508	19 7/10"	10 7/10"	4 2/5"
10"	FSWYE10	810005509	21 2/5"	11 4/5"	4 9/10"
12"	FSWYE12	810005510	24 9/10"	14"	5 4/5"
14"	FSWYE14	810007018	28 3/10"	16 1/10"	6 3/5"

Tee Cap

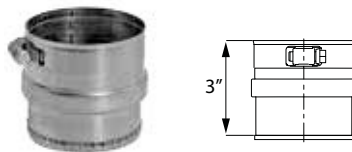

Use to cap Standard Tee, Branch Tee or Boot Tee. Remove Tee Cap to inspect the system; clean out debris or collected condensate.

SIZE	ORDER #	STOCK #	SIZE	ORDER #	STOCK #
3"	FSTC3	810003114	12"	FSTC12	810003484
4"	FSTC4	810003168	14"	FSTC14	810003524
5"	FSTC5	810003224	16"	FSTC16	810003559
6"	FSTC6	810003277	18"	FSTC18	810003588
7"	FSTC7	810003323	20"	FSTC20	810003608
8"	FSTC8	810003365	22"	FSTC22	810003628
9"	FSTC9	810003405	24"	FSTC24	810003647
10"	FSTC10	810003443			

Universal Condensate Drain



Use to properly manage corrosive condensates common with high efficiency gas appliances. For best results, install close to the appliance. Can be used horizontally, vertically, or any angle in between. The top photo shows the 3"-5" diameters with 5/8" straight tube; the bottom photo shows 6"-16" diameters with a 1" IPS Fitting.

SIZE	ORDER #	STOCK #	A	B
3"	FSUCD3	810003115	6 2/5"	5/8"
4"	FSUCD4	810003169	6 2/5"	5/8"
5"	FSUCD5	810003225	6 2/5"	5/8"
6"	FSUCD6	810003278	6 2/5"	1 1/4"
7"	FSUCD7	810003324	6 2/5"	1 1/4"
8"	FSUCD8	810003366	6 2/5"	1 1/4"
9"	FSUCD9	810003406	6 2/5"	1 1/4"
10"	FSUCD10	810003444	6 2/5"	1 1/4"
12"	FSUCD12	810003485	6 2/5"	1 1/4"
14"	FSUCD14	810003525	6 2/5"	1 1/4"
16"	FSUCD16	810003560	6 2/5"	1 1/4"

Drain Fitting

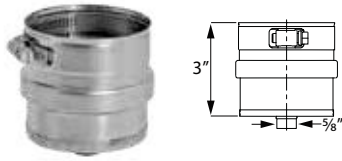

Use instead of Tee Cap to manage condensates at the bottom of a vertical run. For vent systems larger than 5", use an IPS Drain Fitting.

SIZE	ORDER #	STOCK #
3"	FSDF3	810003116
4"	FSDF4	810003170
5"	FSDF5	810003226

IPS Drain Fitting



Use to connect iron drain pipe to flow acidic condensates to a neutralization tank before disposal. Uses 1" NPT thread.

SIZE	ORDER #	STOCK #	SIZE	ORDER #	STOCK #
3"	FSIPSDF03	810003117	12"	FSIPSDF12	810003486
4"	FSIPSDF04	810003171	14"	FSIPSDF14	810003526
5"	FSIPSDF05	810003227	16"	FSIPSDF16	810003561
6"	FSIPSDF06	810003279	18"	FSIPSDF18	810003589
7"	FSIPSDF07	810003325	20"	FSIPSDF20	810003609
8"	FSIPSDF08	810003367	22"	FSIPSDF22	810003629
9"	FSIPSDF09	810003407	24"	FSIPSDF24	810003648
10"	FSIPSDF10	810003445			

Horizontal Drain Fitting



Use to manage condensates in horizontal runs. Optimal when ganging multiple appliances into a common vent. The top photo shows the 3"-5" diameters with 5/8" straight tube; the bottom photo shows 6"-16" diameters with a 1" IPS Fitting.

SIZE	ORDER #	STOCK #	A	B
3"	FSHDF03	810003118	3 1/2"	5/8"
4"	FSHDF04	810003172	3 1/2"	5/8"
5"	FSHDF05	810003228	3 1/2"	5/8"
6"	FSHDF06	810003280	4 3/8"	1 1/4"
7"	FSHDF07	810003326	4 3/8"	1 1/4"
8"	FSHDF08	810003368	4 3/8"	1 1/4"
9"	FSHDF09	810003408	4 3/8"	1 1/4"
10"	FSHDF10	810003446	4 3/8"	1 1/4"
12"	FSHDF12	810003487	4 3/8"	1 1/4"
14"	FSHDF14	810003527	4 3/8"	1 1/4"
16"	FSHDF16	810003562	4 3/8"	1 1/4"

Horizontal Drip Tee

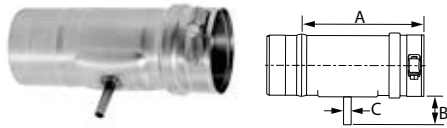

Use to manage condensate in horizontal runs.

SIZE	ORDER #	STOCK #	A	B	C
3"	FSHDT3	810003119	6"	1 1/2"	3/8"
4"	FSHDT4	810003173	6"	1 1/2"	3/8"

Bird Screen



Use for 3" and 4" standard through-the-wall terminations. Check installation instructions for restrictions on horizontal terminations, such as minimum distance from windows and doors.

SIZE	ORDER #	STOCK #	A
3"	FSBS3	810003120	2"
4"	FSBS4	810003174	2"

23° Bird Screen

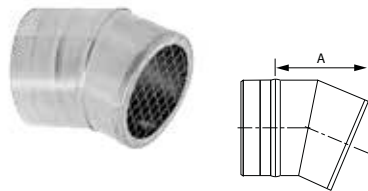

Use for 5" to 16" through-the-wall termination. Deters rain and other elements from entering the vent system. Check installation instructions for restrictions on horizontal terminations, such as minimum distance from windows and doors.

SIZE	ORDER #	STOCK #	A
5"	FSBS5	810003229	4 1/8"
6"	FSBS6	810003281	5 3/8"
7"	FSBS7	810003327	6 2/5"
8"	FSBS8	810003369	7 1/10"
9"	FSBS9	810003409	7 9/10"
10"	FSBS10	810003447	8 7/10"
12"	FSBS12	810003488	10 1/2"
14"	FSBS14	810003528	11 7/10"
16"	FSBS16	810003563	13 1/2"

Termination Tee



Use for standard and high-wind through-the-wall terminations. Check installation instructions for restrictions on horizontal terminations, such as minimum distance from windows and doors.

SIZE	ORDER #	STOCK #	A	B
3"	FSTT3	810003121	3"	6"
4"	FSTT4	810003175	3 1/2"	7"
5"	FSTT5	810003230	4"	8"
6"	FSTT6	810003282	4 1/2"	9"

Termination Box

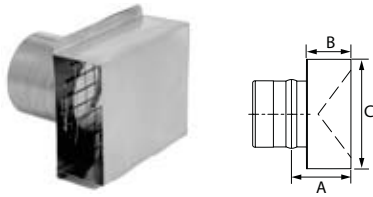

Use for horizontal through-the-wall terminations. Check installation instructions for restrictions on horizontal terminations, such as minimum distance from windows and doors. Larger sizes available, contact customer service.

SIZE	ORDER #	STOCK #	A	B	C
3"	FSTB3	810003122	2 3/16"	2"	5"
4"	FSTB4	810003176	2 3/16"	2"	6"

Wall Thimble w/ Termination Damper

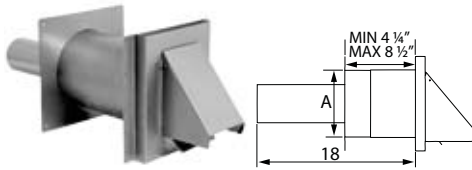

Use for horizontal through-the-wall terminations. Check installation instructions for restrictions on horizontal cap terminations, such as minimum distance from windows and doors. Accommodates wall thickness of 4 1/4" to 8 1/2". Damper prevents backdraft of cold air to appliance. Not a UL Listed component.

SIZE	ORDER #	STOCK #	A
3"	FSWTT3	810003123	6"
4"	FSWTT4	810003177	7"
5"	FSWTT5	810005425	8"

Wall Thimble w/AVL

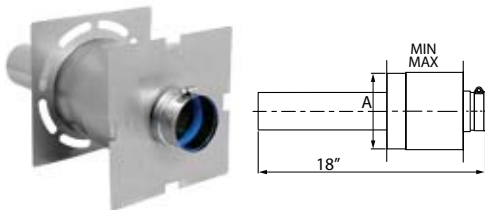

Use for through-the-wall termination. Fits between standard wall studs. 3"-5" diameters accommodates wall thickness of 4 1/4" to 8 1/2". 6"-16" diameters accommodate wall thickness of 5 3/4" to 11 1/2". AVL pipe allows for adjustability in length variance.

SIZE	ORDER #	STOCK #	A
3"	FSWT3	810003124	5"
4"	FSWT4	810003178	6"
5"	FSWT5	810003231	7"
6"	FSWT6	810003284	8"
7"	FSWT7	810003328	9"
8"	FSWT8	810003371	10"
9"	FSWT9	810003410	11"
10"	FSWT10	810003448	12"
12"	FSWT12	810003489	13"
14"	FSWT14	810003529	14"
16"	FSWT16	810003564	15"

Wall Pass Through

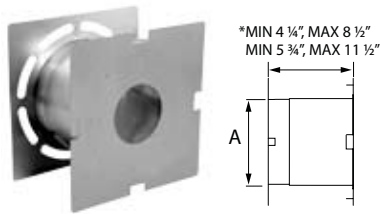

Use for through-the-wall termination. Fits between standard wall studs. 3"-5" diameters accommodates wall thickness of 4 1/4" to 8 1/2". 6"-16" diameters accommodate wall thickness of 5 3/4" to 11 1/2".

SIZE	ORDER #	STOCK #	A	SIZE	ORDER #	STOCK #	A
3"	FSWPT3	810003125	6"	9"	FSWPT9	810003530	12"
4"	FSWPT4	810003179	7"	10"	FSWPT10	810003449	13"
5"	FSWPT5	810003232	8"	12"	FSWPT12	810003490	15"
6"	FSWPT6	810003285	9"	14"	FSWPT14	810003530	17"
7"	FSWPT7	810003329	10"	16"	FSWPT16	810003565	19"
8"	FSWPT8	810003372	11"				

Wall Thimble Sleeve Extension

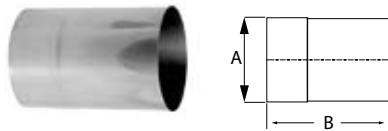

Use to add 6" of length to Wall Pass Through and Wall Thimble for thicker walls.

SIZE	ORDER #	STOCK #	A
3"	FSWTE3	810003126	6"
4"	FSWTE4	810003180	7"
5"	FSWTE5	810003233	8"
6"	FSWTE6	810003286	9"
7"	FSWTE7	810003330	10"
8"	FSWTE8	810003373	11"
9"	FSWTE9	810003412	12"
10"	FSWTE10	810003450	13"
12"	FSWTE12	810003491	15"
14"	FSWTE14	810003531	17"
16"	FSWTE16	810003566	19"

Firestop/Flat Flashing

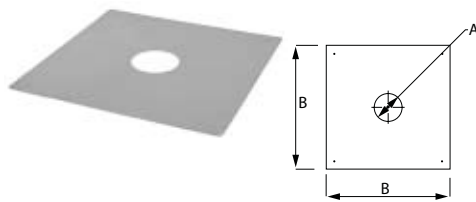

Use when penetrating floor levels.

SIZE	ORDER #	STOCK #	A	B	SIZE	ORDER #	STOCK #	A	B
3"	FSFS3	810003127	3 3/5"	15"	12"	FSFS12	810003492	12 3/5"	24"
4"	FSFS4	810003181	4 3/5"	15"	14"	FSFS14	810003532	14 3/5"	26"
5"	FSFS5	810003234	5 3/5"	17"	16"	FSFS16	810003567	16 3/5"	28"
6"	FSFS6	810003287	6 3/5"	17"	18"	FSFS18	810003591	18 3/5"	30"
7"	FSFS7	810003331	7 3/5"	19"	20"	FSFS20	810003611	20 3/5"	32"
8"	FSFS8	810003374	8 3/5"	19"	22"	FSFS22	810003631	22 3/5"	34"
9"	FSFS9	810003413	9 3/5"	22"	24"	FSFS24	810003650	24 3/5"	36"
10"	FSFS10	810003451	10 3/5"	22"					

Support Clamp



Use to support vertical and horizontal runs using threaded rod. Recommended every 10' on vertical runs and every 6' in horizontals. Use additional Support Clamps as needed.

SIZE	ORDER #	STOCK #	A	SIZE	ORDER #	STOCK #	A
3"	FSCL3	810003128	1 1/2"	12"	FSCL12	810003493	1 1/2"
4"	FSCL4	810003182	1 1/2"	14"	FSCL14	810003533	1 1/2"
5"	FSCL5	810003288	1 1/2"	16"	FSCL16	810003568	1 1/2"
6"	FSCL6	810003288	1 1/2"	18"	FSCL18	810003592	1 1/2"
7"	FSCL7	810003332	1 1/2"	20"	FSCL20	810003612	1 1/2"
8"	FSCL8	810003375	1 1/2"	22"	FSCL22	810003632	1 1/2"
9"	FSCL9	810003414	1 1/2"	24"	FSCL24	810003651	1 1/2"
10"	FSCL10	810003452	1 1/2"				

Wall Bracket

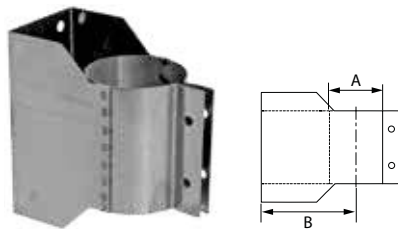

Use to support vent pipe or tee sections. Provides proper clearance to combustibles.

SIZE	ORDER #	STOCK #	A	B	SIZE	ORDER #	STOCK #	A	B
3"	FSWB3	810003129	3"	3 1/2"	9"	FSWB9	810003415	9"	6 1/2"
4"	FSWB4	810003183	4"	4"	10"	FSWB10	810003453	10"	7"
5"	FSWB5	810003236	5"	4 1/2"	12"	FSWB12	810003494	12"	8"
6"	FSWB6	810003289	6"	5"	14"	FSWB14	810003534	14"	9"
7"	FSWB7	810003333	7"	5 1/2"	16"	FSWB16	810003569	16"	10"
8"	FSWB8	810003376	8"	6"					

Adjustable Wall Bracket

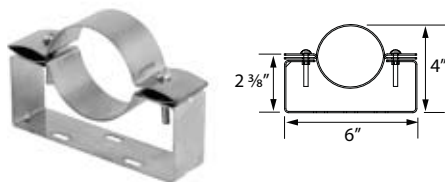

Use to support vent pipe in lateral and horizontal runs. Assist in achieving proper pitch for condensate management. Adjusts up to 3".

SIZE	ORDER #	STOCK #
3"	FSAWB03	810003130
4"	FSAWB04	810003184

Rain Cap

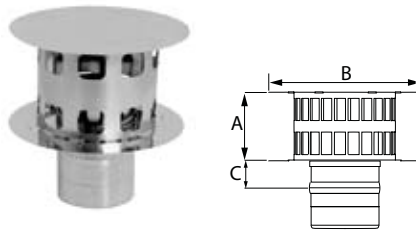

Use to terminate above the roof line. When terminating above 12" vent diameter use a Termination Cone.

SIZE	ORDER #	STOCK #	A	B	C
3"	FSRC3	810003131	3 1/2"	6 4/5"	1"
4"	FSRC4	810003185	4 1/2"	8 9/10"	1"
5"	FSRC5	810003237	5 4/5"	11 3/10"	1"
6"	FSRC6	810003292	6 4/5"	13 1/2"	1"
7"	FSRC7	810003334	7 4/5"	15 4/5"	1"
8"	FSRC8	810003377	8 4/5"	18"	1"
9"	FSRC9	810003416	10"	20 3/10"	1"
10"	FSRC10	810003454	11"	22 1/2"	1"
12"	FSRC12	810003495	13"	27"	1"

Severe Weather Rain Cap

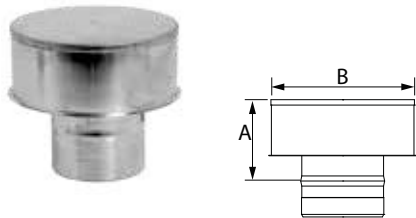

Use where high winds and horizontal rain are present. For vertical termination only.

SIZE	ORDER #	STOCK #	A	B
4"	FSSWRC04	810003186	6"	7 1/10"

Termination Cone

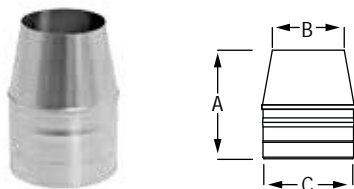

Use for vertical termination. Creates static back pressure to adjust harmonics. Venturi effect increases velocity of flue gases. Reduced opening provides for a smaller cross section to deter rain from entering the system. **Available in custom size combinations.**

SIZE	ORDER #	STOCK #	A	B	C
5" x 4"	FSCN0504	810003244	6 3/5"	4"	5"
12" x 10"	FSCN1210	810003496	6 3/5"	10"	12"
14" x 12"	FSCN1412	810003535	6 3/5"	12"	14"
16" x 14"	FSCN1614	810003570	6 3/5"	14"	16"
18" x 16"	FSCN1816	810003590	6 3/5"	16"	18"
20" x 18"	FSCN2018	810003610	6 3/5"	18"	20"
22" x 20"	FSCN2220	810003630	6 3/5"	20"	22"
24" x 22"	FSCN2422	810003649	6 3/5"	22"	24"

Storm Collar

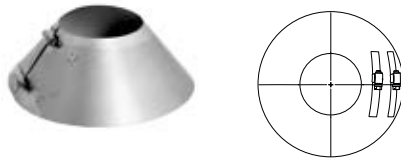

Use to create a weather tight seal between the pipe and flashing.

SIZE	ORDER #	STOCK #	SIZE	ORDER #	STOCK #
3"	FSC3	810003132	12"	FSC12	810003501
4"	FSC4	810003188	14"	FSC14	810003538
5"	FSC5	810003239	16"	FSC16	810003572
6"	FSC6	810003293	18"	FSC18	810003594
7"	FSC7	810003336	20"	FSC20	810003614
8"	FSC8	810003381	22"	FSC22	810003634
9"	FSC9	810003419	24"	FSC24	810003653
10"	FSC10	810003460			

Roof Jack



Use as a heat shield within the flashing. Maintains center-line and clearance to combustibles.

SIZE	ORDER #	STOCK #	A	SIZE	ORDER #	STOCK #	A
3"	FSVRJ3	810003133	4"	12"	FSVRJ12	810003502	13"
4"	FSVRJ4	810003189	5"	14"	FSVRJ14	810003539	15"
5"	FSVRJ5	810003240	6"	16"	FSVRJ16	810003573	17"
6"	FSVRJ6	810003294	7"	18"	FSVRJ18	810003595	19"
7"	FSVRJ7	810003337	8"	20"	FSVRJ20	810003615	21"
8"	FSVRJ8	810003382	9"	22"	FSVRJ22	810005454	23"
9"	FSVRJ9	810003420	10"	24"	FSVRJ24	810003654	25"
10"	FSVRJ10	810003461	11"				

Variable Pitch Roof Flashing

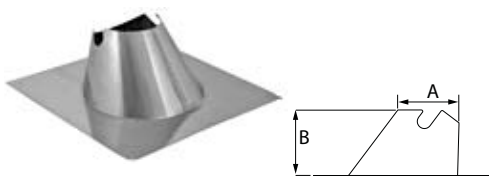

Use to create a weather-tight penetration where the vent pipe passes through the roof. Roof Jack and Storm Collar required. 3"-24"Ø accommodates flat to 9/12 roof pitch.

SIZE	ORDER #	STOCK #	A	B	SIZE	ORDER #	STOCK #	A	B
3"	FSVPF3	810003134	5"	7"	12"	FSVPF12	810003503	14"	7"
4"	FSVPF4	810003190	6"	7"	14"	FSVPF14	810003540	16"	7"
5"	FSVPF5	810003241	7"	7"	16"	FSVPF16	810003574	18"	7"
6"	FSVPF6	810003295	8"	7"	18"	FSVPF18	810003596	20"	28 1/2"
7"	FSVPF7	810003338	9"	7"	20"	FSVPF20	810003616	22"	29 1/2"
8"	FSVPF8	810003383	10"	7"	22"	FSVPF22	810003635	24"	30 1/2"
9"	FSVPF9	810003421	11"	7"	24"	FSVPF24	810003655	26"	31 1/2"
10"	FSVPF10	810003462	12"	7"					

Tall Cone Roof Jack

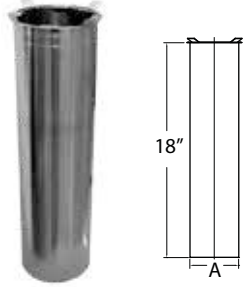

Use as a heat shield within the flashing. Maintains center-line and clearance to combustibles. Use with Tall Cone Flashings.

SIZE	ORDER #	STOCK #	A	SIZE	ORDER #	STOCK #	A
3"	FSRJ3	810005286	4"	9"	FSRJ9	810005290	10"
4"	FSRJ4	810005287	5"	10"	FSRJ10	810005291	11"
5"	FSRJ5	810005288	6"	12"	FSRJ12	810005292	13"
6"	FSRJ6	810005289	7"	14"	FSRJ14	810005293	15"
7"	FSRJ7	810007023	8"	16"	FSRJ16	810005294	17"
8"	FSRJ8	810005434	9"				

Tall Cone Flashing

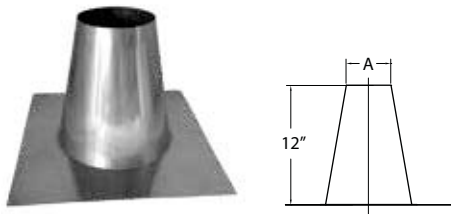

Use to create a weather-tight penetration where the vent passes through the roof. Roof Jack and Storm Collar required.

SIZE	ORDER #	STOCK #	A	SIZE	ORDER #	STOCK #	A
3"	FSAF3	810005257	4 1/3"	9"	FSAF9	810005263	10 1/3"
4"	FSAF4	810005258	5 1/3"	10"	FSAF10	810005264	11 1/3"
5"	FSAF5	810005259	6 1/3"	12"	FSAF12	810005269	13 1/3"
6"	FSAF6	810005260	7 1/3"	14"	FSAF14	810005270	15 1/3"
7"	FSAF7	810005261	8 1/3"	16"	FSAF16	810005271	17 1/3"
8"	FSAF8	810005262	9 1/3"				

Tapered Increaser

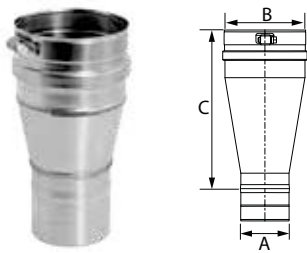

Use to increase vent diameter. Creates a smooth transition for an undistruptive flow. **Available in custom size combinations.**

SIZE	ORDER #	STOCK #	A	B	C
3" x 4"	FS0304TI	810003136	3"	4"	6 9/10"
4" x 5"	FS0405TI	810003191	4"	5"	6 9/10"

Eccentric Increaser



Use to transition to a larger diameter pipe. Prevents condensate puddling when used on horizontal runs. Aids in reducing formation of condensates. Maximum 10" difference between diameter increase size on both sizes. **Available in custom size combinations.**

SIZE	ORDER #	STOCK #	A	B	C
3" x 4"	FS0304EI	810003137	6"	8"	10 3/8"
4" x 5"	FS0405EI	810003193	4"	5"	7 3/25"

Stepped In increaser

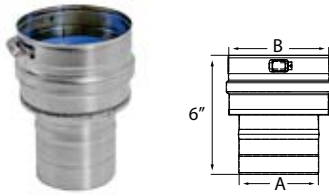

Use to increase vent diameter when space constraints are an issue. **Available in custom size combinations.**

SIZE	ORDER #	STOCK #	A	B
3" x 4"	FS34I	810003138	3"	4"
4" x 5"	FS45I	810003195	4"	5"

Tapered Reducer

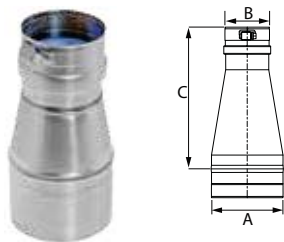

Use to reduce vent diameter. Creates a smooth transition for an undistruptive flow. Maximum 10" diameter increase size on both sizes. **Available in custom size combinations.**

SIZE	ORDER #	STOCK #	A	B	C
4" x 3"	FS0403TR	810003192	4"	3"	6 1/10"
5" x 4"	FS0504TR	810003242	5"	4"	6 1/10"

Stepped Reducer

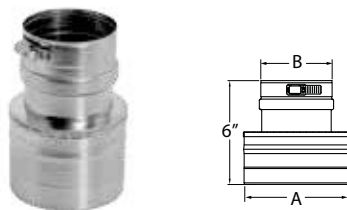

Use to reduce vent diameter when space constraints are an issue. **Available in custom size combinations.**

SIZE	ORDER #	STOCK #	A	B
4" x 3"	FS43R	810003194	4"	3"
5" x 4"	FS54R	810003243	5"	4"

Double-Wall Adapter

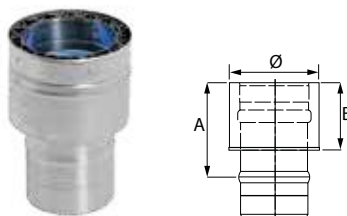

Use to transition from a single-wall pipe to double-wall pipe.

SIZE	ORDER #	STOCK #	A	B	SIZE	ORDER #	STOCK #	A	B
3"	FSA-SWDW3	810003139	4"	3"	12"	FSA-SWDW12	810003505	4"	3"
4"	FSA-SWDW4	810003197	4"	3"	14"	FSA-SWDW14	810003542	4"	3"
5"	FSA-SWDW5	810003246	4"	3"	16"	FSA-SWDW16	810003576	4"	3"
6"	FSA-SWDW6	810003298	4"	3"	18"	FSA-SWDW18	810003593	4"	3"
7"	FSA-SWDW7	810003340	4"	3"	20"	FSA-SWDW20	810003613	4"	3"
8"	FSA-SWDW8	810003385	4"	3"	22"	FSA-SWDW22	810003633	4"	3"
9"	FSA-SWDW9	810003423	4"	3"	24"	FSA-SWDW24	810003652	4"	3"
10"	FSA-SWDW10	810003464	4"	3"					

Standard Wall Mount Kit



Kit includes: Wall Thimble w/ Termination, Adjustable 90° Elbow, and Universal Appliance Adapter.

Use to vent wall mounted boilers or tankless water heaters. Terminates through-the-wall only. Available in 3", 4" and 5" vent diameters. Adjust vertically from 16 1/2" to 21" and horizontally from 8" to 12 1/2". 3"& 4" compatible with most gas-burning appliances. 5" compatible with tankless. Not a UL Listed component.

SIZE	ORDER #	STOCK #
3"	FSWMKB3	810003070
4"	FSWMK4	810003071
5"	FSWMK5	810003072

Severe Weather Kit



Kit includes: Wall Thimble w/ Termination Tee, Adjustable 90° Elbow, and Universal Appliance Adapter w/Condensate Drain and Back Draft Preventer.

Use to vent wall mounted boilers or tankless water heaters. Use in areas of extreme wet and cold weather. Designed to prevent appliance freeze-up while maintaining an obstruction free exhaust. Available in 4" vent diameters, compatible with most 4" exhaust gas appliances. Add a 90° Elbow and Vent Length on the outside of the house to clear high snow lines.

SIZE	ORDER #	STOCK #
4"	FSSWWMK4	810003075

Variable Pitch Flashing Kit



Kit includes: Rain Cap, Storm Collar, Roof Jack, and Roof Flashing. (*VPKA Kit includes: a Universal Appliance Adapter w/ Condensate Drain).

Use to terminate through-the-roof vent systems. Kit accommodates flat to 9/12 roof pitch.

SIZE	ORDER #	STOCK #	SIZE	ORDER #	STOCK #
3"	FSVPK3	810003056	9"	FSVPK9	810003062
4"	FSVPK4	810003057	10"	FSVPK10	810003063
4"	FSVPA4*	810003067	12"	FSVPK12	810003064
5"	FSVPK5	810003058	14"	FSVPK14	810003065
6"	FSVPK6	810003059	16"	FSVPK16	810003066
7"	FSVPK7	810003060			
8"	FSVPK8	810003061			

90° Bird Screen Wall Mount Kit



Kit includes: 90° Bird Screen Termination, Wall Thimble, Adjustable 90° Elbow, and Universal Appliance Adapter.

Use to vent wall mounted boilers or tankless water heaters. 3" kit adjusts vertically from 14 1/2" to 19" and horizontally from 9" to 13 1/2". 4" kit adjusts vertically from 14" to 18 1/2" and horizontally from 9" to 13 1/2". Compatible with all Rheem gas appliances. 3" kit requires a FSA-RI-4.2 Adapter.

SIZE	ORDER #	STOCK #
3"	FSWMKEB3	810003073
4"	FSWMKE4	810003074

Ceiling Mounted Heater Vent Kit



Kit includes Termination Tee, Wall Thimble w/Adjustable Vent Length, (2) 12" Vent Lengths, and Universal Appliance Adapter. *4" kit includes Universal Appliance Adapter with Condensate Drain.

Use to vent ceiling mounted heaters, through-the-wall termination only. Compatible with Modine ceiling heaters.

SIZE	ORDER #	STOCK #
3"	FSCMK3	810003068
4"	FSCMK04	810003069

Universal Concentric Kit

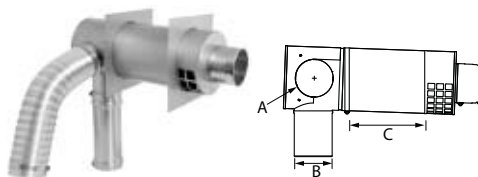

Use for through-the-wall termination with direct vent wall mounted gas appliances. Features an adjustable right and left hand air intake snout and accommodates wall thickness of 10" - 18". Check installation instructions for restrictions on horizontal termination, such as minimum distance from windows and doors.

SIZE	ORDER #	STOCK #	A	B	C
4"	FSEDVWMT04U	810003081	4"	4"	10" - 18"
5"	FSEDVWMT05U	810003084	5"	5"	10" - 18"

Wall Mount Concentric Kit

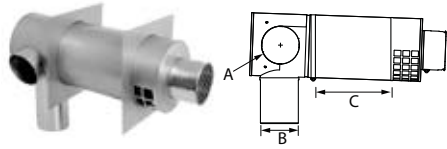

Use for through-the-wall termination with direct vent wall mounted gas appliances. Features a fixed right or left hand air intake snout and accommodates a maximum of 8" wall thickness. Check installation instructions for restrictions on horizontal termination, such as minimum distance from windows and doors.

SIZE	ORDER #	STOCK #	A	B	C
4"	FDVWMT0403RH	810003077	4"	3"	8" max.
4"	FDVWMT0403LH	810003078	4"	3"	8" max.
4"	FDVWMT04RH	810003079	4"	4"	8" max.
4"	FSEDVWMT04LH	810003080	4"	4"	8" max.

Remote Concentric Kit

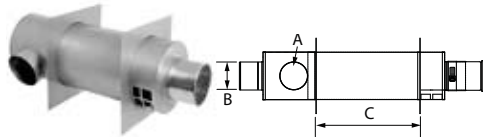

Use for through-the-wall termination with direct vent gas appliances located away from the wall. Check installation instructions for restrictions on horizontal termination, such as minimum distance from windows and doors.

SIZE	ORDER #	STOCK #	A	B	C
3"	FDVMT03	810003085	3"	3"	11" max.
4"	FDVWT04	810003083	4"	4"	11" max.
4"	FDVWT0403	810003082	3"	4"	11" max.

FasNSeal W2® - Double-Wall

Vent Length

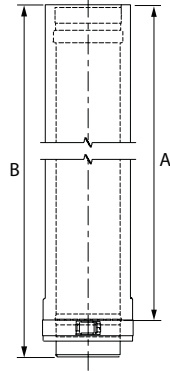

Used for venting special gas burning Categories II, III and IV appliances. To calculate O.D. add 1" to vent diameter.

SIZE	ORDER #	STOCK #	A	B	SIZE	ORDER #	STOCK #	A	B
3"	W2-603	810003656	4"	6"	10"	W2-2410	810003806	22"	24"
3"	W2-1203	810003657	10"	12"	10"	W2-3610	810003807	34"	36"
3"	W2-1803	810003658	16"	18"	12"	W2-612	810003828	4"	6"
3"	W2-2403	810003659	22"	24"	12"	W2-1212	810003829	10"	12"
3"	W2-3603	810003660	34"	36"	12"	W2-1812	810003830	16"	18"
4"	W2-604	810003677	4"	6"	12"	W2-2412	810003831	22"	24"
4"	W2-1204	810003678	10"	12"	12"	W2-3612	810003832	34"	36"
4"	W2-1804	810003679	16"	18"	14"	W2-614	810003853	4"	6"
4"	W2-2404	810003680	22"	24"	14"	W2-1214	810003854	10"	12"
4"	W2-3604	810003681	34"	36"	14"	W2-1814	810003855	16"	18"
5"	W2-605	810003698	4"	6"	14"	W2-2414	810003856	22"	24"
5"	W2-1205	810003699	10"	12"	14"	W2-3614	810003857	34"	36"
5"	W2-1805	810003700	16"	18"	16"	W2-616	810003876	4"	6"
5"	W2-2405	810003701	22"	24"	16"	W2-1216	810003877	10"	12"
5"	W2-3605	810003702	3"	36"	16"	W2-1816	810003878	16"	18"
6"	W2-606	810003719	4"	6"	16"	W2-2416	810003879	22"	24"
6"	W2-1206	810003720	10"	12"	16"	W2-3616	810003880	34"	36"
6"	W2-1806	810003721	16"	18"	18"	W2-618	810003899	4"	6"
6"	W2-2406	810003722	22"	24"	18"	W2-1218	810003900	10"	12"
6"	W2-3606	810003723	34"	36"	18"	W2-1818	810003901	16"	18"
7"	W2-607	810003740	4"	6"	18"	W2-2418	810003902	22"	24"
7"	W2-1207	810003741	10"	12"	18"	W2-3618	810003903	34"	36"
7"	W2-1807	810003742	16"	18"	20"	W2-620	810003916	4"	6"
7"	W2-2407	810003743	22"	24"	20"	W2-620	810003916	10"	12"
7"	W2-3607	810003744	34"	36"	20"	W2-1220	810003917	16"	18"
8"	W2-608	810003760	4"	6"	20"	W2-1820	810003918	22"	24"
8"	W2-1208	810003761	10"	12"	20"	W2-2420	810003919	34"	36"
8"	W2-1808	810003762	16"	18"	22"	W2-3620	810003920	4"	6"
8"	W2-2408	810003763	22"	24"	22"	W2-1222	810003934	10"	12"
8"	W2-3608	810003764	34"	36"	22"	W2-1822	810003935	16"	18"
9"	W2-609	810003783	4"	6"	22"	W2-2422	810003936	22"	24"
9"	W2-1209	810003784	10"	12"	22"	W2-3622	810003937	34"	36"
9"	W2-1809	810003785	16"	18"	24"	W2-624	810003949	4"	6"
9"	W2-2409	810003786	22"	24"	24"	W2-1224	810003950	10"	12"
9"	W2-3609	810003787	34"	36"	24"	W2-1824	810003951	16"	18"
10"	W2-610	810003803	4"	6"	24"	W2-2424	810003952	22"	24"
10"	W2-1210	810003804	10"	12"	24"	W2-3624	810003953	34"	36"
10"	W2-1810	810003805	16"	18"					

Adjustable Vent Length

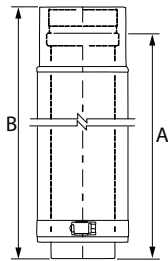

Use to add variable length to your straight length of FasNSeal pipe. Adds 2"-14" of length. Requires at least 4" overlap for a secure connection.

SIZE	ORDER #	STOCK #	A	B	SIZE	ORDER #	STOCK #	A	B
3"	W2-AVL3	810003661	2"-14"	18"	12"	W2-AVL12	810003833	2"-14"	18"
4"	W2-AVL4	810003682	2"-14"	18"	14"	W2-AVL14	810003858	2"-14"	18"
5"	W2-AVL5	810003703	2"-14"	18"	16"	W2-AVL16	810003881	2"-14"	18"
6"	W2-AVL6	810003724	2"-14"	18"	18"	W2-AVL18	810003904	2"-14"	18"
7"	W2-AVL7	810003745	2"-14"	18"	20"	W2-AVL20	810003921	2"-14"	18"
8"	W2-AVL8	810003765	2"-14"	18"	22"	W2-AVL22	810003938	2"-14"	18"
9"	W2-AVL9	810003788	2"-14"	18"	24"	W2-AVL24	810003954	2"-14"	18"
10"	W2-AVL10	810003808	2"-14"	18"					

90° Elbow

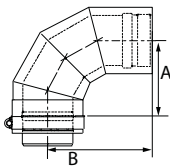

Use to go from horizontal to vertical runs or vertical to horizontal runs. Use to turn vent 90°.

SIZE	ORDER #	STOCK #	A	B	SIZE	ORDER #	STOCK #	A	B
3"	W2-9003	810003662	4"	6"	12"	W2-9012	810003834	8 1/2"	10 1/4"
4"	W2-9004	810003683	4 1/2"	6 1/4"	14"	W2-9014	810003859	9 1/2"	11 3/8"
5"	W2-9005	810003704	5"	6 3/4"	16"	W2-9016	810003882	11"	12 1/2"
6"	W2-9006	810003725	5 1/2"	7 1/2"	18"	W2-9018	810003905	11 1/2"	13 1/8"
7"	W2-9007	810003746	6 1/8"	7 7/8"	20"	W2-9020	810003922	12 1/2"	14 1/2"
8"	W2-9008	810003766	6 1/2"	8 1/4"	22"	W2-9022	810003939	13 3/8"	15"
9"	W2-9009	810003789	7"	9"	24"	W2-9024	810003955	14 1/2"	16 1/8"
10"	W2-9010	810003809	7 1/2"	9 3/8"					

88° Elbow

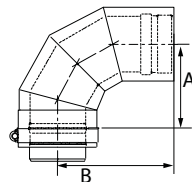

Use to transition from a vertical to a horizontal run. Facilitates a 2° pitch towards the condensate drain for good condensate management.

SIZE	ORDER #	STOCK #	A	B	SIZE	ORDER #	STOCK #	A	B
3"	W2-8803	810003663	4"	6"	12"	W2-8812	810003835	8 1/2"	10 1/4"
4"	W2-8804	810003684	4 1/2"	6 3/5"	14"	W2-8814	810003860	9 1/2"	11 3/8"
5"	W2-8805	810003705	5"	6 3/4"	16"	W2-8816	810003883	11"	12 1/2"
6"	W2-8806	810003726	5 1/2"	7 1/2"					
7"	W2-8807	810003747	6 1/8"	7 7/8"					
8"	W2-8808	810003767	6 1/2"	8 1/4"					
9"	W2-8809	810003790	7"	9"					
10"	W2-8810	810003810	7 1/2"	9 3/8"					

45° Elbow

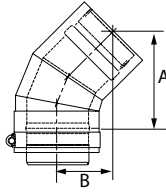

Offsets obstructions as needed. Allows for better condensate management and less back pressure.

SIZE	ORDER #	STOCK #	A	B	SIZE	ORDER #	STOCK #	A	B
3"	W2-4503	810003664	5 3/8"	3"	12"	W2-4512	810003836	8 1/2"	4 1/4"
4"	W2-4504	810003685	5 5/8"	3 1/8"	14"	W2-4514	810003861	9 1/4"	4 5/8"
5"	W2-4505	810003706	6"	3 1/4"	16"	W2-4516	810003884	10"	4 7/8"
6"	W2-4506	810003727	6 3/8"	3 3/8"	18"	W2-4518	810003907	11 1/8"	5"
7"	W2-4507	810003748	6 3/4"	3 1/2"	20"	W2-4520	810003924	12 7/8"	5 1/4"
8"	W2-4508	810003768	7 1/8"	3 5/8"	22"	W2-4522	810003941	11 5/8"	5 5/8"
9"	W2-4509	810003791	7 1/2"	3 7/8"	24"	W2-4524	810003957	12 3/8"	5 7/8"
10"	W2-4510	810003811	7 7/8"	4"					

30° Elbow

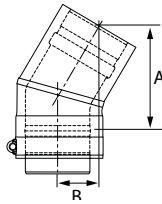

Offsets obstructions as needed. Allows for better condensate management and less back pressure.

SIZE	ORDER #	STOCK #	A	B	SIZE	ORDER #	STOCK #	A	B
3"	W2-3003	810003665	4 7/8"	1 7/8"	9"	W2-3009	810003792	7"	2 1/2"
4"	W2-3004	810003686	5 1/8"	1 7/8"	10"	W2-3010	810003812	6 1/2"	2 1/4"
5"	W2-3005	810003707	5 1/4"	2"	12"	W2-3012	810003837	7"	2 1/2"
6"	W2-3006	810003728	5 1/2"	2"	14"	W2-3014	810003862	7 1/2"	2 1/2"
7"	W2-3007	810003749	5 7/8"	2"	16"	W2-3016	810003885	8 1/8"	2 3/4"
8"	W2-3008	810003769	6 1/8"	2 1/8"					

15° Elbow

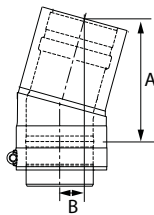

Offsets obstructions as needed. Allows for better condensate management and less back pressure.

SIZE	ORDER #	STOCK #	A	B	SIZE	ORDER #	STOCK #	A	B
3"	W2-1503	810003666	4 3/8"	7/8"	9"	W2-1509	810003793	5 1/4"	1"
4"	W2-1504	810003687	4 1/2"	1"	10"	W2-1510	810003813	5 1/4"	1"
5"	W2-1505	810003708	4 5/8"	7/8"	12"	W2-1512	810003838	5 1/2"	1"
6"	W2-1506	810003729	4 3/4"	7/8"	14"	W2-1514	810003863	5 3/4"	1"
7"	W2-1507	810003750	4 7/8"	1"	16"	W2-1516	810003886	6 1/8"	1"
8"	W2-1508	810003770	5 1/8"	1"					

Standard Tee

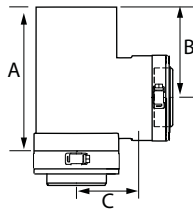

Use for a 90° offset, to combine connections from two or more appliances into a common vent or as a condensate management point when used in conjunction with drain fitting. All Standard Tees have completely welded inner walls.

SIZE	ORDER #	STOCK #	A	B	C	SIZE	ORDER #	STOCK #	A	B	C
3"	W2-T3	810003667	7 3/10"	4 1/2"	3"	12"	W2-T12	810003839	16 3/10"	9"	7"
4"	W2-T4	810003688	8 3/10"	4 4/5"	3 1/2"	14"	W2-T14	810003864	20 3/10"	11"	8 1/2"
5"	W2-T5	810003709	9 3/10"	5 3/10"	4"	16"	W2-T16	810003887	22 3/10"	12"	9 1/2"
6"	W2-T6	810003730	10 3/10"	5 4/5"	4 1/2"	18"	W2-T18	810003908	22 7/8"	12 1/2"	11"
7"	W2-T7	810003751	11 3/10"	6 3/10"	5"	20"	W2-T20	810003925	24 7/8"	13 1/2"	12"
8"	W2-T8	810003771	12 3/10"	6 4/5"	5 1/2"	22"	W2-T22	810003942	26 7/8"	14 1/2"	13"
9"	W2-T9	810003794	13 3/10"	7 3/10"	6"	24"	W2-T24	810003958	28 7/8"	15 1/2"	14"
10"	W2-T10	810003814	14 3/10"	7 4/5"	6 1/2"						

Wide Mouth Boot Tee

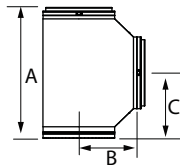

Use to transition from horizontal to vertical with improved flue gas flow with angled gradual transitions. Can also be used as a manifold connection to gang boilers into a common vent. Completely welded inner walls.

SIZE	ORDER #	STOCK #	A	B	C	SIZE	ORDER #	STOCK #	A	B	C
4"	W2-WBT4	810003689	15 3/4"	7"	6 9/10"	12"	W2-WBT12	810003840	23 3/4"	11"	10 9/10"
5"	W2-WBT5	810003710	16 3/4"	7 1/2"	7 4/10"	14"	W2-WBT14	810003865	25 3/4"	12"	11 9/10"
6"	W2-WBT6	810003731	17 3/4"	8"	7 9/10"	16"	W2-WBT16	810003888	27 3/4"	13"	12 9/10"
7"	W2-WBT7	810003752	18 3/4"	8 1/2"	8 4/10"	18"	W2-WBT18	810003909	29 3/4"	14"	13 9/10"
8"	W2-WBT8	810003772	19 3/4"	9"	8 9/10"	20"	W2-WBT20	810003926	31 3/4"	15"	14 9/10"
9"	W2-WBT9	810003795	20 3/4"	9 1/2"	9 4/10"	22"	W2-WBT22	810003943	33 3/4"	16"	15 9/10"
10"	W2-WBT10	810003815	21 3/4"	10"	9 9/10"	24"	W2-WBT24	810003959	35 3/4"	17"	16 9/10"

Double-Wall Wye

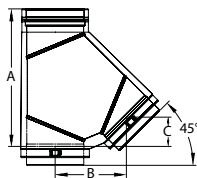

Use in place of any M&G DuraVent tee for a 45° angle instead of 90°; can be used as a manifold connection to gang multiple boilers into a common vent.

SIZE	ORDER #	STOCK #	A	B	C
6"	W2-WYE06	810004863	14 1/2"	7 1/2"	3 1/10"
7"	W2-WYE07	810007021	16 1/3"	8 3/5"	3 1/2"
8"	W2-WYE08	810004864	18"	9 7/10"	4"
9"	W2-WYE09	810007022	19 7/10"	10 7/10"	4 2/5"
10"	W2-WYE10	810004865	21 2/5"	11 4/5"	4 9/10"
12"	W2-WYE12	810004866	24 9/10"	14"	5 4/5"
14"	W2-WYE14	810004867	28 3/10"	16 1/10"	6 3/5"

Tee Cap

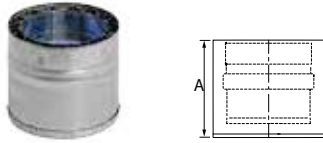

Use to cap Standard Tee, Branch Tee or Boot Tee. Remove Tee Cap to inspect the system; clean out debris.

SIZE	ORDER #	STOCK #	A	SIZE	ORDER #	STOCK #	A
3"	W2-TC3	810003668	3 1/2"	12"	W2-TC12	810003841	3 1/2"
4"	W2-TC4	810003690	3 1/2"	14"	W2-TC14	810003866	3 1/2"
5"	W2-TC5	810003711	3 1/2"	16"	W2-TC16	810003889	3 1/2"
6"	W2-TC6	810003732	3 1/2"	18"	W2-TC18	810003910	3 1/2"
7"	W2-TC7	810003753	3 1/2"	20"	W2-TC20	810003927	3 1/2"
8"	W2-TC8	810003774	3 1/2"	22"	W2-TC22	810003944	3 1/2"
9"	W2-TC9	810003796	3 1/2"	24"	W2-TC24	810003960	3 1/2"
10"	W2-TC10	810003817	3 1/2"				

Drain Fitting



Use instead of Tee Cap to manage condensates at the bottom of a vertical run. For vent systems larger than 5", use an IPS Drain Fitting.

SIZE	ORDER #	STOCK #	A	B
3"	W2-DF3	810003670	3 1/2"	5/8"
4"	W2-DF4	810003692	3 1/2"	5/8"
5"	W2-DF5	810003713	3 1/2"	5/8"

IPS Drain Fitting

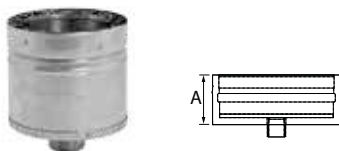

Use to connect iron drain pipe to flow acidic condensates to a neutralization tank before disposal. Uses 1" NPT thread.

SIZE	ORDER #	STOCK #	A	SIZE	ORDER #	STOCK #	A
3"	W2-IPSDF3	810003671	3 1/2"	12"	W2-IPSDF12	810003843	3 1/2"
4"	W2-IPSDF4	810003693	3 1/2"	14"	W2-IPSDF14	810003868	3 1/2"
5"	W2-IPSDF5	810003714	3 1/2"	16"	W2-IPSDF16	810003890	3 1/2"
6"	W2-IPSDF6	810003734	3 1/2"	18"	W2-IPSDF18	810003911	3 1/2"
7"	W2-IPSDF7	810003755	3 1/2"	20"	W2-IPSDF20	810003928	3 1/2"
8"	W2-IPSDF8	810003775	3 1/2"	22"	W2-IPSDF22	810003945	3 1/2"
9"	W2-IPSDF9	810003798	3 1/2"	24"	W2-IPSDF24	810003961	3 1/2"
10"	W2-IPSDF10	810003818	3 1/2"				

Wall Thimble w/AVL

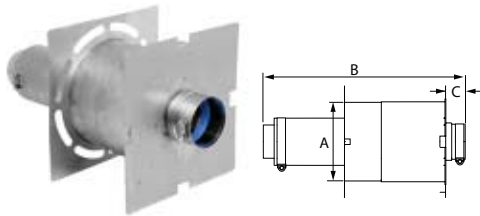

Use for through-the-wall termination. Fits between standard wall studs. 3"-5" diameters accommodates wall thickness of 4 1/4" to 8 1/2". 6"-16" diameters accommodate wall thickness of 5 3/4" to 11 1/2". AVL pipe allows for adjustability in length variance.

SIZE	ORDER #	STOCK #	A	B	C
3"	W2-WT3	810003672	9"	18"	1 1/2"
4"	W2-WT4	810003694	10"	18"	1 1/2"
5"	W2-WT5	810003715	11"	18"	1 1/2"
6"	W2-WT6	810003735	12"	18"	1 1/2"
7"	W2-WT7	810003756	13"	18"	1 1/2"
8"	W2-WT8	810003776	14"	18"	1 1/2"
9"	W2-WT9	810003799	15"	18"	1 1/2"
10"	W2-WT10	810003819	16"	18"	1 1/2"
12"	W2-WT12	810003844	18"	18"	1 1/2"
14"	W2-WT14	810003869	20"	18"	1 1/2"
16"	W2-WT16	810003892	22"	18"	1 1/2"

Wall Thimble Sleeve

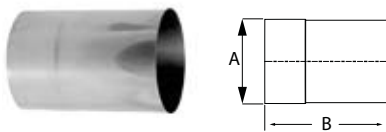

When installing FasNSeal W2 with this component use 1" larger diameter, (e.g. 10" vent system, use 11" size).

SIZE	ORDER #	STOCK #	A	B
3"	FSWTE3	810003126	6"	9"
4"	FSWTE4	810003180	7"	9"
5"	FSWTE5	810003233	8"	9"
6"	FSWTE6	810003286	9"	9"
7"	FSWTE7	810003330	10"	9"
8"	FSWTE8	810003373	11"	9"
9"	FSWTE9	810003412	12"	9"
10"	FSWTE10	810003450	13"	9"
12"	FSWTE12	810003491	15"	9"
14"	FSWTE14	810003531	17"	9"
16"	FSWTE16	810003566	19"	9"

Support Clamp

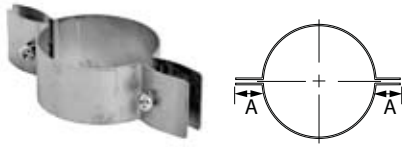

Use to support vertical and horizontal runs. Recommended every 10' in the vertical run. Use additional Support Clamps as needed. When installing FasNSeal W2 with this component use 1" larger diameter, (e.g. 10" vent system, use 11" size).

SIZE	ORDER #	STOCK #	A	SIZE	ORDER #	STOCK #	A
4"	FSCL4	810003182	1 1/2"	13"	FSCL13	810003849	1 1/2"
5"	FSCL5	810003235	1 1/2"	15"	FSCL15	810003873	1 1/2"
6"	FSCL6	810003288	1 1/2"	17"	FSCL17	810003895	1 1/2"
7"	FSCL7	810003332	1 1/2"	19"	FSCL19	810003913	1 1/2"
8"	FSCL8	810003375	1 1/2"	21"	FSCL21	810003930	1 1/2"
9"	FSCL9	810003414	1 1/2"	23"	FSCL23	810003947	1 1/2"
10"	FSCL10	810003452	1 1/2"	25"	FSCL25	810003963	1 1/2"
11"	FSCL11	810003825	1 1/2"				

Rain Cap

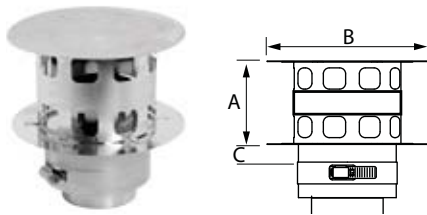

Use where pipe terminates above the roof line. When terminating larger than 12" vent diameter use a Termination Cone.

SIZE	ORDER #	STOCK #	A	B	C
3"	W2-RC3	810003673	3 1/2"	6 4/5"	1"
4"	W2-RC4	810003695	4 1/2"	8 9/10"	1"
5"	W2-RC5	810003716	5 4/5"	11 3/10"	1"
6"	W2-RC6	810003736	6 4/5"	13 1/2"	1"
7"	W2-RC7	810003757	7 4/5"	15 4/5"	1"
8"	W2-RC8	810003777	8 4/5"	18"	1"
9"	W2-RC9	810003800	10"	20 3/10"	1"
10"	W2-RC10	810003820	11"	22 1/2"	1"
12"	W2-RC12	810003845	13"	27"	1"

Termination Cone

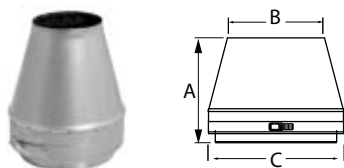

Use for vertical termination. Creates static back pressure to adjust harmonics. Venturi effect increases velocity of flue gases. Reduced opening provides for a smaller cross section to deter rain from entering the system. **Available in custom size combinations.**

SIZE	ORDER #	STOCK #	A	B	C
8" x 6"	W2-CN0806	810003778	8"	6"	6 2/5"
14" x 12"	W2-CN1412	810003870	14"	12"	6 2/5"

Stepped Increaser

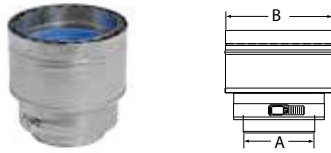

Use to increase vent diameter when space constraints are an issue. **Available in custom size combinations.**

SIZE	ORDER #	STOCK #	A	B
4" x 5"	W2-45I	810003696	4"	5"
8" x 9"	W2-89I	810003779	8"	9"

Tapered Increaser

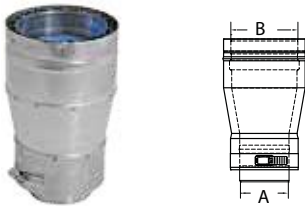

Use to increase vent diameter. Creates a smooth transition for an undistruptive flow. FasNSeal W2 has a 10" max change in diameter. **Available in custom size combinations.**

SIZE	ORDER #	STOCK #	A	B
3" x 4"	W2-0304TI	810003674	3"	4"
3" x 6"	W2-0306TI	810003675	3"	6"

Eccentric Increaser



Use to transition to a larger diameter pipe. Adjusts the systems center point to offset from obstructions. Aids in reducing formation of condensates on horizontal runs. FasNSeal W2 has a 10" max change in diameter. **Available in custom size combinations.**

SIZE	ORDER #	STOCK #	A	B
8" x 10"	W2-0810E1	810003781	8"	10"

Stepped Reducer



Use to reduce vent diameter when space constraints are an issue. **Available in custom size combinations.**

SIZE	ORDER #	STOCK #	A	B
7" x 5"	W2-75R	810003758	7"	5"
12" x 10"	W2-1210R	810003847	12"	10"

Tapered Reducer



Use to reduce vent diameter. Creates a smooth transition for an undistruptive flow. FasNSeal W2 has a 10" max change in diameter. **Available in custom size combinations.**

SIZE	ORDER #	STOCK #	A	B
8" x 7"	W2-0807TR	810003780	8"	7"
10" x 7"	W2-1007TR	810003822	10"	7"

Single-Wall Adapter

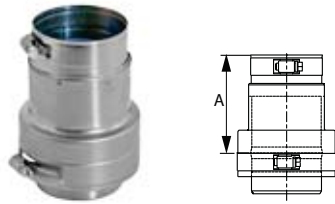

Use to transition from double-wall pipe to single-wall pipe.

SIZE	ORDER #	STOCK #	A	SIZE	ORDER #	STOCK #	A
3"	FSA-DWSW3	810003676	4"	9"	FSA-DWSW9	810003801	4"
4"	FSA-DWSW4	810003697	4"	10"	FSA-DWSW10	810003821	4"
5"	FSA-DWSW5	810003717	4"	12"	FSA-DWSW12	810003846	4"
6"	FSA-DWSW6	810003737	4"	14"	FSA-DWSW14	810003871	4"
7"	FSA-DWSW7	810003759	4"	16"	FSA-DWSW16	810003893	4"
8"	FSA-DWSW8	810003782	4"				

Firestop/Flat Flashing

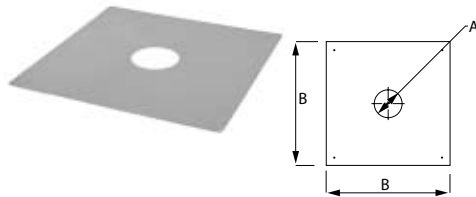

Use when penetrating floor levels. When installing double-wall with this component use 1" larger diameter, (e.g. 10" vent system, use 11" size).

SIZE	ORDER #	STOCK #	A	B	SIZE	ORDER #	STOCK #	A	B
4"	FSFS4	810003181	4 1/4"	15"	15"	FSFS15	810003872	15 3/8"	28"
5"	FSFS5	810003234	5 3/8"	17"	16"	FSFS16	810003567	16 3/8"	28"
6"	FSFS6	810003287	6 3/8"	17"	17"	FSFS17	810003894	17 3/8"	30"
7"	FSFS7	810003331	7 3/8"	19"	18"	FSFS18	810003591	18 3/8"	30"
8"	FSFS8	810003374	8 3/8"	19"	19"	FSFS19	810003912	19 3/8"	32"
9"	FSFS9	810003413	9 3/8"	22"	20"	FSFS20	810003611	20 3/8"	32"
10"	FSFS10	810003451	10 3/8"	22"	21"	FSFS21	810003929	21 3/8"	34"
11"	FSFS11	810003823	11 3/8"	24"	22"	FSFS22	810003631	22 3/8"	34"
12"	FSFS12	810003492	12 3/8"	24"	23"	FSFS23	810003946	23 3/8"	36"
13"	FSFS13	810003848	13 3/8"	26"	24"	FSFS24	810003650	24 3/8"	36"
14"	FSFS14	810003532	14 3/8"	26"					

Wall Bracket

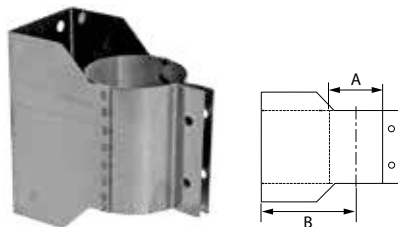

Use to support vent pipe or tee sections. Provides proper clearance to combustibles. When installing FasNSeal W2 with this component use 1" larger diameter, (e.g. 10" vent system, use 11" size).

SIZE	ORDER #	STOCK #	A	B	SIZE	ORDER #	STOCK #	A	B
4"	FSWB4	810003183	4"	4"	11"	FSWB11	810003826	11"	7 1/2"
5"	FSWB5	810003236	5"	4 1/2"	12"	FSWB12	810003494	12"	8"
6"	FSWB6	810003289	6"	5"	13"	FSWB13	810003850	13"	8 1/2"
7"	FSWB7	810003333	7"	5 1/2"	14"	FSWB14	810003534	14"	9"
8"	FSWB8	810003376	8"	6"	15"	FSWB15	810003874	15"	9 1/2"
9"	FSWB9	810003415	9"	6 1/2"	16"	FSWB16	810003569	16"	10"
10"	FSWB10	810003453	10"	7"	17"	FSWB17	810003896	17"	10 1/2"

Bird Screen

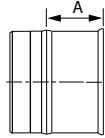

Use for 3" and 4" standard through-the-wall terminations. Check installation instructions for restrictions on horizontal terminations, such as minimum distance from windows and doors.

SIZE	ORDER #	STOCK #	A
3"	FSBS3	810003120	2"
4"	FSBS4	810003174	2"

23° Bird Screen

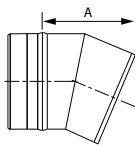

Use for 5" to 16" through-the-wall termination. Deters rain and other elements from entering the vent system. Check installation instructions for restrictions on horizontal terminations, such as minimum distance from windows and doors.

SIZE	ORDER #	STOCK #	A
5"	FSBS5	810003229	4 4/5"
6"	FSBS6	810003281	5 3/5"
7"	FSBS7	810003327	6 2/5"
8"	FSBS8	810003369	7 1/10"
9"	FSBS9	810003409	7 9/10"
10"	FSBS10	810003447	8 7/10"
12"	FSBS12	810003488	10 1/5"
14"	FSBS14	810003528	11 7/10"
16"	FSBS16	810003563	13 1/5"

Termination Tee

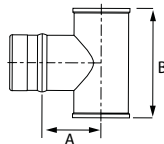

Use for standard and high-wind through-the-wall terminations. Check installation instructions for restrictions on horizontal terminations, such as minimum distance from windows and doors.

SIZE	ORDER #	STOCK #	A	B
3"	FSTT3	810003121	3"	6"
4"	FSTT4	810003175	3 1/2"	7"
5"	FSTT5	810003230	4"	8"
6"	FSTT6	810003282	4 1/2"	9"

Termination Box

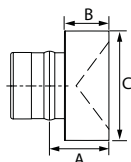

Use for horizontal through-the-wall terminations. Check installation instructions for restrictions on horizontal terminations, such as minimum distance from windows and doors.

SIZE	ORDER #	STOCK #	A	B	C
3"	FSTB3	810003122	2 3/10"	2"	5"
4"	FSTB4	810003176	2 3/10"	2"	6"

Storm Collar



Use to create a weather tight seal between the pipe and flashing. When installing FasNSeal W2 with this component use 1" larger diameter, (e.g. 10" vent system, use 11" size).

SIZE	ORDER #	STOCK #	SIZE	ORDER #	STOCK #
4"	FSC4	810003188	13"	FSC13	810003852
5"	FSC5	810003239	15"	FSC15	810003875
6"	FSC6	810003293	17"	FSC17	810003898
7"	FSC7	810003336	19"	FSC19	810003915
8"	FSC8	810003381	21"	FSC21	810003932
9"	FSC9	810003419	23"	FSC23	810003948
10"	FSC10	810003460	25"	FSC25	810003965
11"	FSC11	810003827			

Variable Pitch Roof Flashing

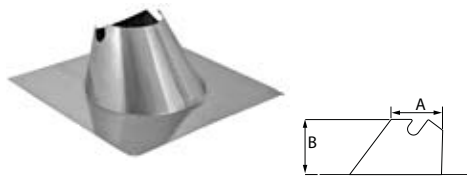

Use to create a weather-tight penetration where the vent pipe passes through the roof. Storm Collar required. When ordering Flashings for FasNSeal W2 product the flashing diameter and vent diameter are the same. ie. W2-3610 requires a FSVPF10. Accommodates flat to 9/12 roof pitch.

SIZE	ORDER #	STOCK #	A	B	SIZE	ORDER #	STOCK #	A	B
4"	FSVPF4	810003190	6"	7"	12"	FSVPF12	810003503	14"	7"
5"	FSVPF5	810003241	7"	7"	14"	FSVPF14	810003540	16"	7"
6"	FSVPF6	810003295	8"	7"	16"	FSVPF16	810003574	18"	7"
7"	FSVPF7	810003338	9"	7"	18"	FSVPF18	810003596	20"	28 1/2"
8"	FSVPF8	810003383	10"	7"	20"	FSVPF20	810003616	22"	29 1/2"
9"	FSVPF9	810003421	11"	7"	22"	FSVPF22	810003635	24"	30 1/2"
10"	FSVPF10	810003462	12"	7"	24"	FSVPF24	810003655	26"	31 1/2"

Tall Cone Flashing

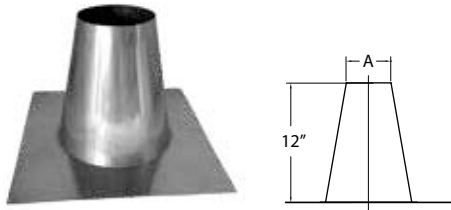

Use to create a weather-tight penetration where the vent pipe passes through the roof. Storm Collar required. When ordering Flashings for FasNSeal W2 product the flashing diameter and vent diameter are the same. ie. W2-3610 requires a FSVPF10.

SIZE	ORDER #	STOCK #	A	SIZE	ORDER #	STOCK #	A
3"	FSAF3	810005257	4 1/3"	9"	FSAF9	810005263	10 1/3"
4"	FSAF4	810005258	5 1/3"	10"	FSAF10	810005264	11 1/3"
5"	FSAF5	810005259	6 1/3"	12"	FSAF12	810005269	13 1/3"
6"	FSAF6	810005260	7 1/3"	14"	FSAF14	810005270	15 1/3"
7"	FSAF7	810005261	8 1/3"	16"	FSAF16	810005271	17 1/3"
8"	FSAF8	810005262	9 1/3"				

Appliances and Adapters

Manufacturer	Model	Appliance Adapter	Termination Adapter	
Aerco International	Benchmark 2.0 GWS, 3.0 LN	FSA-AE8		
	KC-1000	FSA-AE6		
	Modulux Series	Standard Vent Pipe 4", 6"		
Ajax	Atlas GS Series	FSA-HFA6, 8		
	A250, A300	FSAAU12		
A.O. Smith	Burkay Genesis Series	FSA-HFA4 a, 5 a		
	Legend 2000 Series	FSA-HFA6 a, 7 a		
	ProStar Series	FSAAU4		
	GB/GW 400, 500	FSAAU6		
	GB/GW 1000	FSAAU10		
	GB/GW 1300, 1500	FSAAU12		
	GB/GW 1850, 2100	FSAAU14		
	GB/GW 2500	FSAAU16		
	GB/GW 300	FSAAU10		
	GB/GW 650, 750	FSAAU8		
	ATI 705-N	FSAAU4		
	ATIO 910-N	FSAAU5		
	Cyclone BTH-150	FSA-PVC3		
	Cyclone BTH-300, 400, 500	FSA-PVC4		
	VW-750	FSA-HFA6		
	VW-1500	FSA-HFA7		
	Aerco	Benchmark 1.5	FSA-AE6	
		Benchmark 750	FSA-AE6	
Benchmark 1000		FSA-AE6		
Benchmark 3000		FSA-AE8		
Benchmark 6000		FSA-AE14		
Esteem 399 (tankless)		FSA-ULT4		
Atlas	300	FS34I		
Beacon/Morris	BRU Series	FSAAU4		
	BTU Series	FSAAU4, 5, 6		
Bosch	Aquastar 125 FX	FSA-LMGD4 a		
	Aquastar GHW-635-ES	Standard Vent Pipe 3"		
	Aquastar 250SX	Standard Vent Pipe 3"		
	Aquastar 240FX	FSAAU3		
	AquaStar 2400ES	FSAAU4		
	AquaStar 2700ES	FSAAU4		
	GWH 425EF	FSAAU4		
	660 EF	FSAAU3		
Bradford-White	EF Series	FSA-PVC3		
Bryan	AB Series	FSAAU		
Buderus	G115 Series	FSAAU4 or FSAAU5		
	G124X Series	FSAAU5, 6		
	G-515/ 7-12	FSAAU10		
	GA124 Series	FSAAU3		
	GA244/37, 44, 53	FSAAU3		

Buderus	GA244/62	FSAAU4	
	GB142 Series	FSAAU3	
	GB312/90 to GB312/160	FSA-158-6F	
	GB312/200 to GB312/280	FSA-197-8F	
	SB615 Series	FSA-SB7, 8, 10, 12	
	SB735 Series	FSA-SB14	
Burnham	Independence PV	FSA-HFB3 b	FSA-PV3
	Minute Man II	FSA-HFB3 b	FSA-PV3
	Revolution	FSA-HFB3 b	FSA-PV3
	Revolution II	FSA-HFB3 b	FSA-PV3
	Series 2PV	FSA-HFB3 b	FSA-PV3
	Spirit	FSA-HFB3 b	FSA-PV3
	PVG/SCG Series	FSA-HFB3 b, 4 b	
	V11 Series	FSAAU8, 10, 12, 14, 16	
	V905	FSAAU8	
	ALP 150	FSA-PVC3	
	ALP 285	FSA-PVC4	
	ALP 399	FSA-PVC4	
	ALP 500	FSA-PVC4	
	Camus Boiler	MicoFlame Series I	FSAAU3, 4, 5, 6
MicoFlame Series II		FSAAU8, 10, 12	
MicoFlame Grande Series		FSAAU12, 14	
DynaFlame Series		FSAAU6, 8, 10, 12, 14	
Camus	DynaMax	Standard Vent Pipe 6"	
	DynaForce 1000	FSAAU6 or 7	
	DynaForce 1600	FSAAU7	
Carel	Humidifier UG 180	FSAAU5	
Cleaver Brooks	MCF Series	FSA-MCF6, 8, 10, 12	
	FLX Series	FSA-FLX10, 12, 16	
	CFC 500	FSAAU6	
	CFC 1000	FSA-MCF8	
	CFC 1500	FSAAU10	
	CFC 1800	FSA-MCF12	
	CFC 2500	FSAAU12	
Columbia	Patriot Series-Direct Vent	FSA-UTC4	
Crown Boiler Co.	Bali BWF-061, 095, 128, 162	Standard Vent Pipe 3" a	FSA-M3 a
	Bali BWF-195, 229	Standard Vent Pipe 4" a	FSA-M4 a
	Bimini BWC150, 225	Standard Vent Pipe 3" a, 4" a	FSA-M3, 4 a
	Bimini 300, 399, 425	Standard Vent Pipe 4" 5"	FSA-M3 a
	CWD 083	FSAAU3	
	BWF-095/ 128/ 162	Standard Vent Pipe 3"	
	BWF-195/ 229	Standard Vent Pipe 4"	
	Cabo CSC-050 thru 150	Standard Vent Pipe 3" a	
	Cabo CSC-175, 200	Standard Vent Pipe 3" a, 4" a	FSA-M3 a
	Cabo II CWD060-245	FSA-HFA3, 4	
Dunkirk	XEB-2 thru XEB-5	FSAMETEK3	FSA-M3 a
	XEB-6 thru XEB-7	FSAMETEK3	

Appliances and Adapters

Manufacturer	Model	Appliance Adapter	Termination Adapter
De Dietrich	GT334A, GT335A, GT336A	FSAAU7	
	GT337A, GT338A, GT339A	FSAAU8	
	GT430-8A to GT430-10A	FSAAU10	
	GT430-11A to GT430-14A	FSAAU12	
	GT-530- 22 thru -25	FSAAU18	
	Series 334,335, 336	FSAAU7	
	Series 337,338, 339	FSAAU8	
	Series 430-11, -12, -13,-14	FSAAU12	
	Series 430-8, -9, -10	FSAAU10	
	Series 310-5,-6, -7, -8, -9	FSAAU10	
	C-230 ECO	FSA-149-6F	
	C-130 ECO	FSA-250-10F	
	C-230 ECO	FSA-149-6F	
	C-310	FSA-250-10F	
EcoTemp	40HI tankless	FSAAUUCD3	
Fulton Boiler Works	PulsePak PHW Series	FSA04T2.5, FSA06T2.5	
	Vantage VTG3000	FSAAU12	
	PHW 2000	FSA06T2.5	
	PHW 1400	FSA04T2.5	
	Vantage VTG 4000 / 6000	FSAAU14	
GasMaster	GMI Series	FSAAU4, 6, 8, 12	
Hamilton	EVO 299, 399, 599	Standard Vent Pipe 4" 5"	
Hayward Pool	H250 FD	FSA-HFA6	
	H300 FD, H350 FD, H400 FD	FSA-HFA8	
HydroTherm	HI Series	FSAAU4	
	ID Series	FSAAU4	
	IHS Series	FSAAU4	
	KN-2	FSA-HFA3	
	KN-4	FSA-HFA4	
	KN-6	FSA-HFA5	
	KN-10 600, 1000, 2000	FSA-HFA4 a, 6 a, 8 a	
	KN-16	Standard Vent Pipe 6"	
	KN-20,30	Standard Vent Pipe 8"	
Sabre FX Series	FSA-ELB3, 4		
Jandy	Hi-E2 model 350	FSAAU4	
	Hi-E2 model 220	FSAAU3	
	Pool heater 250	FSAAU6	
	Pool heater 300	FSAAU7	
	Pool heater 400	FSAAU8	
Laars	Endurance EBP	FSA-B3 a	
	Endurance EDP	FSA-B3 a	
	Mascot	FSA-80MM3	
	Mini Combo id Series	FSAAU4	
	Mini Therm JVi	FSA-LMGD4 a	
	Pennant Series	FSAAU6, 8, 10, 12	

Laars	Rheos 1200 - 2400	FSAAU6, 7, 10 a	
	Rheos Plus 1200 - 2400	FSAAU6, 7, 10 a	
	Summit 200, 250	FSA-PVC3	
	NeoTherm 285, 399, 500, 600	Standard Vent Pipe 4"	
	NeoTherm NT 750, 850	Standard Vent Pipe 6"	
	MightyTherm 2	FSAAU	
Lennox	CMWB 2, 3, 4, 5, 6, 7	Standard Vent Pipe	
	CXE 2, 3, 4, 5, 6, 7	Standard Vent Pipe	
Lochinvar	AWN 286- 601	FSA-4PVC-4FNS	
	Copper Fin CBN	FSAAU6, 8, 10, 12, 14	
	Copper Fin II CHN	FSAAU6, 8, 10, 12, 14	
	Crest 500	Standard Vent Pipe 7"	
	Crest 2000	Standard Vent Pipe 8"	
	Crest 2500	Standard Vent Pipe 9"	
	Crest 3000	Standard Vent Pipe 10"	
	Crest 3500	Standard Vent Pipe 10"	
	Crest 4000	Standard Vent Pipe 12"	
	Crest 5000	Standard Vent Pipe 14"	
	Efficiency+ EBN 100	FSA-PSC/DE3 a	
	Efficiency+ EBN 150, 200	FSAAU4	
	Efficiency+ EBN 250, 300	FSAAU5	
	ERN 252, 302, 402	FSAAU6	
	IWN 1500	FSAAU6	
	Knight 51-211	FSA-23803-FNS	
	Knight	FSA-PVC3, 4	
	Kight XL 399 thru 600	FSA-4PVC-4FNS	
	Kight XL 700 thru 800	FSA-6M-6PVC ELB	
	Intelli-Fin IBN 1500 thru 2000	FSA-200mm8/FSA150mm6	
	Power-Fin PBN 501 thru 2000	FSAAU7, 8, 9, 10, 12	
	Power-Fin PFN 501 thru 2000	FSAAU7, 8, 9, 10, 12	
	Shield 285 - 500	FSA-4PVC-4FNS	
SYNC SBN 1000, 1300, 1500	Standard Vent Pipe 6"		
Efficiency EWN 300	FSAAU6		
Modine	BDP	Standard Vent Pipe 3" a d	FSA-M3 a
	Model HDS30, 45, 60, 75	FSAAU3, 4	FSA-M3, 4 a
	PDP	Standard Vent Pipe 3" a d	FSA-M3 a
Navien	CC240, CC240A	FSA-PVC4	
New Yorker	PVCG Series	FSA-HFB3 b	FSA-NYV3 a
Nordyne	FG6RA Series	FSAAU3, 4, 5	
	FG6RC-045	FSA-PVC3 a	
Nortec	GS Series 100 thru 600	FSAAU3, 4, 5, 6	
	GH Series 100 thru 400	FSAAU3, 4	
	N-0531S	FSA-APD3	
	N-0631S	FSAAU4	

Appliances and Adapters

Noritz	N-0751M	FSAAU4	
	N-0751M-DV	FSAAU4	
	N-0931M	FSAAU4	FSA-NSC4
	N-0931M-DV	FSAAU4	
	N-0931M ASME	FSAAU4	
	N-0931M-DV ASME	FSAAU4	FSA-NSC4
	NH-1501-DV ASME	FSAAU4	FSA-NSC4
	NH-2001-DV ASME	FSAAU4	
	N-1321M	FSAAU5	
	NC 380	FSAAU5	
	N 0531S	FSA-APD3	
	NR66	FSAAN03	
	NR-71	FSAAU4	
	NR 89SV	FSAAU4	
Paloma	N069M	FSAAU4	
	PH28RIFSN/P	FSAAU4	
	PH28CIFSN/P	FSAAU4	
	PH20RIFSN/P	FSA-RI-4.2	
	PTG42PVN/P	FSA-RI-4.2	
	PTG-74 PVN	FSAAU4	
Patterson-Kelley	P-K Thermific Series	FSAAU10, 12	
	P-K Modu-Fire Series (except FD)	W2-AA10, 12	
	P-K Modu-Fire FD	FSAAU6, 8	
	P-K MACH c-300, 450, 900, 1050	FSA-PK4, 5, 8	
	P-K MACH c-750	FSA-PKT6 or Standard Vent Pipe 6"	
	C1500 & C2000	FSA-250-10F	
Pentair	MiniMax NT, MasterTemp	std. 4" avl w/ RTV & stepped increaser	
Peerless	Cast 92-4	FSA-HFA4	
	DE Series	FSA-PSC/DE3 a	
	PDE Series	FSA-PDE3 a	
	PSC Series	FSA-PSC/DE3 a	
	PSC II Series	FSA-HFA3	
	PF-210	FSA-3PVCN-3FNS	
	PF-399	FS1610TR	
	PF850, PF-1000	Standard Vent Pipe 6"	
Pencco	FSB Series	FSAMETEK3	
Pentair	MiniMax NT	TBA	
PVI	Power VT Series	FSA-HFA4 a	
	Platinum 399	FSA-PVC4	
	1400N 250A-PV	FSA-PVC4	
	TurboPower 500N 25A-TP	FSAAU5	
	TurboPower 750N- 1500N	FSAAU6	
Quietside	QVM8 Series	FSAAU3	FSA-PV3
	DPW 199	FSA-PVC4	
	DPW 120A	FSA-PVC3	

Raypak	Advanced Design Boiler ADB-500	FSAAU6	
	ADB-750 thru 1501	FSAAU8, 10, 12	
	Hi Delta 122 thru 2342	FSAAU4, 5, 6, 8, 12, 14, 16	
	MVB 1003	FSAAU6	
Raypak	MVB 2003, 1753, 1503, 1253	FSAAU8	
	Pool heater CR-406A	FSAAU9	
	Pool heater CR-336A	FSAAU8	
	Pool heater CR-266A	FSAAU7	
	Pool heater CR-206A	FSAAU6	
	Pool heater P-514	FSAAU10	
	X-Therm WH-1505, 2005	FSAAU8	
	X-Therm WH-1005	FSAAU6	
	X-Therm H2005	FSAAU8	
	Xfyre 300, 400, 500	FSA-ULT4	
RBI	Fusion Series	FSA-HFA	
	Futera II Series	FSA-HFA	
	Futera III Series	FSA-HFA	
	Dominator Series	FSA-HFA	
	LCD Dominator Series	FSA-HFA	
Rheem/Ruud	RTG-42PVN (Pronto 4.2)	FSA-RI-4.2	
	RTG-74 (Pronto 7.4)	FSAAU4	
	RL-75i	FSAAU4	
Slantfin	Caravan Series	FSA-HFA3 a	
	Concept 21 Series	FSA-HFA3 a	FSA-NYV3 a
	Prodigy 21	FSA-HFA3 a	
	Victory VSPH Series	FSA-HFA3 a	
	Victory II Series	FSA-HFA3 a	
Smith	HB 28A	FSAA18	
	Series 19A -5, -6	FSAAU8	
	Series 19A -7	FSAAU9	
	Series 19A -8, -12	FSAAU10	
	Cast Iron - 28A	FSAAU	
Smith Cast Iron	GV100 Series	FSA-SMITH4	
	Lexington GS110 Series	FSA-ELB3, 4	
	GT 200	FSAAU3	
State Water Heater	Aurora GAX194	FSAAU14	
StayRite	Pool Heater	FSA-STARITE-4	
Takagi	TH-2S-DV	Standard Vent Pipe 4"	
	T-H1	FSAAU4	FSA-TTA4
	T-K1	FSAAU4	FSA-TTA4
	T-K2	FSAAU4	FSA-TTA4
	T-K3	FSAAU4	FSA-TTA4
	T-K1S	FSAAU4	FSA-TTA4
	T-K Jr.	FSAAU4	FSA-TTA4
	T-KD20	FSAAU4	FSA-TTA4
	T-M1	FSAAU4	FSA-TTA4

Appliances and Adapters

	T-M50	FSAAU5	FSA-TTA4
	Solaris	FSA-TS6	
Thermo-Dynamics	LMGD Series	FSA-LMGD4 a	FSA-LMGDTERM4 a
	CWL-GS Series	TBA	
Thermal Solutions	Evolution Series	FSA-HFA3 a, 4 a, 6 a, 8 a	
Triad	1600 (steam)	FSAAU8	
	900 (steam)	FSAAU8	
Triangle Tube	Delta Performance	FSA-TR3	
	Delta Performance Plus	FSA-TR3	
	Prestige Solo 250	FSA-ULT3	
	Prestige Solo 399	FSA-ULT4	
	Prestige Solo 110	FSA-ULT3	
	Solo 250	FSA-ULT3	
	Solo 399	FSA-ULT4	
U.S. Boiler	ESC series	Standard Vent Pipe	
Utica	USC Series	Standard Vent Pipe a d	
	DV-B Series	Standard Vent Pipe a d	
Vapac	GF Series	FSA-GF3	
Viessmann	Vitocrossal 300 CT-3 Series	FSAAU8, 10, 12	
	Vitogas 50 ECV Series	Standard Vent Pipe 3" a	FSA-M3 a
	Vitogas 100 GS10 Series	FSAAU8, 9, 10	
	Vertomat VSB-37, 46, 57	TBA	
	Vitodens WB2 Series	FSA-V3, 4	
	Vitorond	FSAAU12	
	WB 100	FSA-80MM3	
Wai Wela	PH-16IFSN/P	FSA-RI-4.2	
	PH-20-RIFS/N	FSA-RI-4.2	
	PH-28RIFSN/P	FSAAU4	
Weben Jarco	Vision 3000 Series	FSA-HFA6, 8, 10 a	
	E-Finity	TBA	
Weil McLain	GV ST	FSA-WEIL-GV3	
	CGi Series	FSA-WM-CG13	
	CGs Series	FSA-WM-CG13	
	CGt Series	FSA-WM-CG13	
	GV GOLD Series 3	FSA-WEIL-GVTEE3	
	GV GOLD Series 4	FSA-WEIL-GVTEE3	
	GV90	FSA-ULT3	
	Ultra Series	FSA-ULT3, 4	
Williamson Thermoflo	GW1 Series	FSA-WM-CG13	

a = High-temperature RTV silicone sealant is required.

b = Can also be vented with FSAVL3 (3") or FSAVL4 (4").

c = Additional Muffler adapters required.

d = Can use FSAAU in place of Standard Vent Length with silicone.

Universal Appliance Adapter

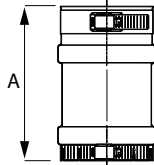

SIZE	ORDER #	STOCK #	A	SIZE	ORDER #	STOCK #	A
3"	FSAAU3	810003966	5 3/8"	9"	FSAAU9	810003982	5 3/8"
4"	FSAAU4	810003970	5 3/8"	10"	FSAAU10	810003984	5 3/8"
5"	FSAAU5	810003972	5 3/8"	12"	FSAAU12	810003987	5 3/8"
6"	FSAAU6	810003974	5 3/8"	14"	FSAAU14	810003990	5 3/8"
7"	FSAAU7	810003977	5 3/8"	16"	FSAAU16	810003992	5 3/8"
8"	FSAAU8	810003980	5 3/8"				

Universal Appliance Adapter w/ Test Port

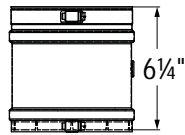

SIZE	ORDER #	STOCK #	SIZE	ORDER #	STOCK #
3"	FSAAUTP3	810003967	9"	FSAAUTP9	810003983
4"	FSAAUTP4	810003971	10"	FSAAUTP10	810003985
5"	FSAAUTP5	810003973	12"	FSAAUTP12	810003988
6"	FSAAUTP6	810003975	14"	FSAAUTP14	810003991
7"	FSAAUTP7	810003978	16"	FSAAUTP16	810003993
8"	FSAAUTP8	810003981			

Universal Appliance Adapter w/ Condensate Drain

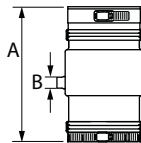

SIZE	ORDER #	STOCK #	A	B
3"	FSAAUCD03	810007011	7 7/10"	5/8"
4"	FSAAUCD04	810003968	7 7/10"	5/8"

Universal Appliance Adapter w/ Condensate Drain and Back Flow Preventer

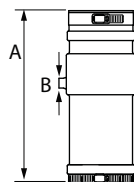

SIZE	ORDER #	STOCK #	A	B
4"	FSAAUDBFP04	810003969	11"	5/8"

W2 Appliance Adapter

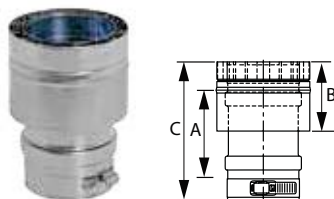

SIZE	ORDER #	STOCK #	A	B	C
3"	W2-AA3	810003994	4 4/5"	3"	6"
4"	W2-AA4	810003996	4 4/5"	3"	6"
5"	W2-AA5	810003998	4 4/5"	3"	6"
6"	W2-AA6	810004000	4 4/5"	3"	6"
7"	W2-AA7	810004002	4 4/5"	3"	6"
8"	W2-AA8	810004005	4 4/5"	3"	6"
9"	W2-AA9	810004006	4 4/5"	3"	6"
10"	W2-AA10	810004008	4 4/5"	3"	6"
12"	W2-AA12	810004010	4 4/5"	3"	6"
14"	W2-AA14	810004012	4 4/5"	3"	6"
16"	W2-AA16	810004014	4 4/5"	3"	6"

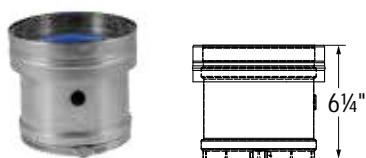
W2 Appliance Adapter
w/ Test Port

SIZE	ORDER #	STOCK #	SIZE	ORDER #	STOCK #
3"	W2-AATP03	810003995	9"	W2-AATP09	810004007
4"	W2-AATP04	810003997	10"	W2-AATP10	810004009
5"	W2-AATP05	810003999	12"	W2-AATP12	810004011
6"	W2-AATP06	810004001	14"	W2-AATP14	810004013
7"	W2-AATP07	810004003	16"	W2-AATP16	810004015
8"	W2-AATP08	810004005			

Metric Male Appliance Adapters

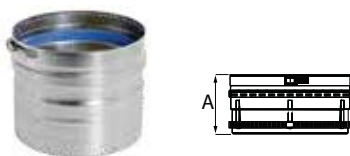

SIZE	ORDER #	STOCK #	A
152 mm	FSA-152-6F	810006989	6"
158 mm	FSA-158-6F	810004016	6"
197 mm	FSA-197-8F	810004017	6"
250 mm	FSA-250-10F	810004018	6"

De Dietrich GT Series
Appliance Adapter

SIZE	ORDER #	STOCK #	A
7"	FSAAU7	810003977	5 3/5"
8"	FSAAU8	810003980	5 3/5"
10"	FSAAU10	810003984	5 3/5"
12"	FSAAU12	810003987	5 3/5"

4" PVC to 4" FasNSeal Appliance Adapter

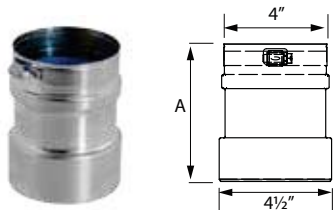

SIZE	ORDER #	STOCK #	A
4"	FSA-4PVC-4FNS	810004019	5 1/2"

Aerco International Appliance Adapter



SIZE	ORDER #	STOCK #	A
6"	FSA-AE6	810004022	11 4/5"
8"	FSA-AE8	810004023	11 4/5"

Laars Endurance Series Appliance Adapter

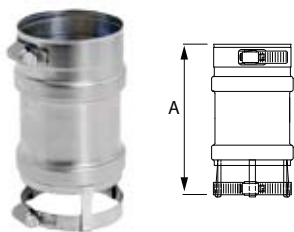

SIZE	ORDER #	STOCK #	A
3"	FSA-B3	810004024	4 4/5"
4"	FSA-B4	810004025	4 4/5"

Elbow Appliance Adapter

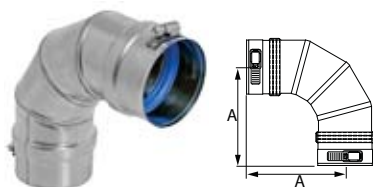

SIZE	ORDER #	STOCK #	A
3"	FSA-ELB3	810004026	6 1/2"
4"	FSA-ELB4	810004027	6 1/2"

Fulton Boiler Appliance Adapter

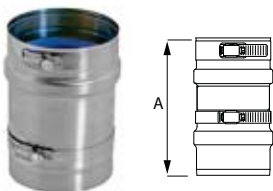

SIZE	ORDER #	STOCK #	A
4"	FSA-F4	810004028	4 9/16"
6"	FSA-F6	810004029	4 9/16"

Heatfab-to-FasNSeal Appliance Adapter

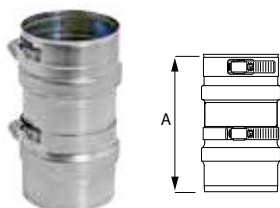

SIZE	ORDER #	STOCK #	A	SIZE	ORDER #	STOCK #	A
3"	FSA-HFA3	810004032	6"	7"	FSA-HFA7	810004036	6"
4"	FSA-HFA4	810004033	6"	8"	FSA-HFA8	810004037	6"
5"	FSA-HFA5	810004034	6"	9"	FSA-HFA9	810004038	6"
6"	FSA-HFA6	810004035	6"	10"	FSA-HFA10	810006988	6"

Burnham & New Yorker Appliance Adapter



SIZE	ORDER #	STOCK #	A
3"	FSA-HFB3	810004039	6"
4"	FSA-HFB4	810004040	6"

Bosch, Thermo-Dynamics & Laars Appliance Adapter

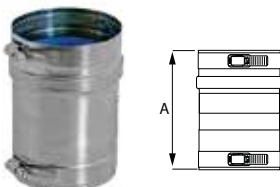

SIZE	ORDER #	STOCK #	A
4"	FSA-LMGD4	810004041	6"

Crown, Dunkirk & Modine Termination Appliance Adapter

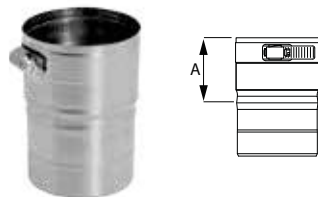

SIZE	ORDER #	STOCK #	A
3"	FSA-M3	810004042	2 1/2"
4"	FSA-M4	810004043	2 1/2"

Cleaver Brooks MCF Series Appliance Adapter



SIZE	ORDER #	STOCK #	A
6"	FSA-MCF6	810004044	6"
8"	FSA-MCF8	810004045	6"
10"	FSA-MCF10	810004046	6"
12"	FSA-MCF12	810004047	6"

Dunkirk XEB Series & Pennco FSB Series Appliance Adapter

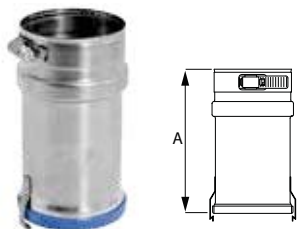

SIZE	ORDER #	STOCK #	A
3"	FSAMETEK3	810004048	6"

Fulton Tapered Appliance Adapter

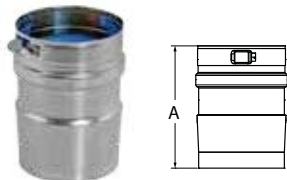

SIZE	ORDER #	STOCK #	A
4"	FSA04T.5	810004030	5 3/4"
6"	FSA06T.5	810004031	5 3/4"

Noritz NOM-DV Series Termination Appliance Adapter

SIZE	ORDER #	STOCK #	A
4"	FSA-NSC4	810004049	4"

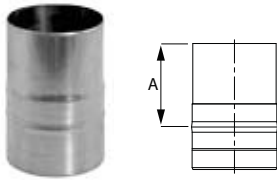

Slantfin Concept & New Yorker PVC Series Termination Appliance Adapter

SIZE	ORDER #	STOCK #	A
3"	FSA-NYV3	810004050	4"

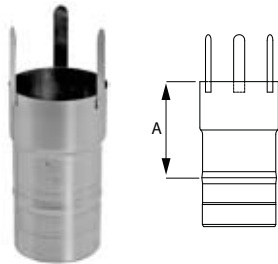

Peerless PDE Model Appliance Adapter

SIZE	ORDER #	STOCK #	A
6"	FSA-PDE3	810004051	6"

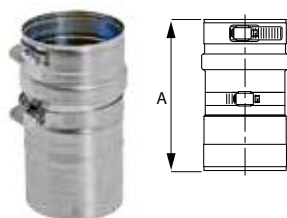

Patterson Kelly Mach Series Appliance Adapter

SIZE	ORDER #	STOCK #	A
4"	FSA-PK4	810004052	8 3/4"
5"	FSA-PK5	810004053	4 7/8"
8"	FSA-PK8	810004054	5 7/8"



Tapered Patterson Kelly Mach Series Appliance Adapter

SIZE	ORDER #	STOCK #	A
6"	FSA-PKT6	810004055	8"

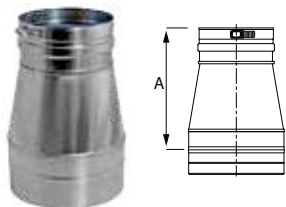

Peerless & Lochinvar Appliance Adapter

SIZE	ORDER #	STOCK #	A
3"	FSA-PSC/DE3	810004056	6"

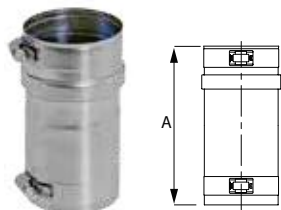

Burnham & Quietside Termination Appliance Adapter

SIZE	ORDER #	STOCK #	A
3"	FSA-PV3	810004057	3"

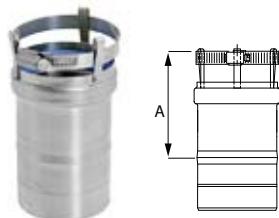

PVC to FasNSeal Appliance Adapter

SIZE	ORDER #	STOCK #	A
3"	FSA-PVC3	810004020	5 1/2"
4"	FSA-PVC4	810004021	5 1/2"

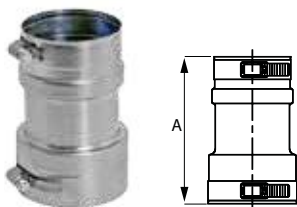

Rheem/Ruud RTG & Paloma PTG/PH Series Appliance Adapter



SIZE	ORDER #	STOCK #	A
3"	FSA-RI	810004058	3"

Buderus SB Series Appliance Adapter

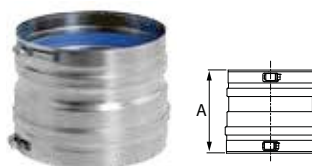

SIZE	ORDER #	STOCK #	A
7"	FSA-SB7	810004059	6"
8"	FSA-SB8	810004060	6"
10"	FSA-SB10	810004061	6"
12"	FSA-SB12	810004062	6"
14"	FSA-SB14	810004063	6"

Smith GV-100 Appliance Adapter

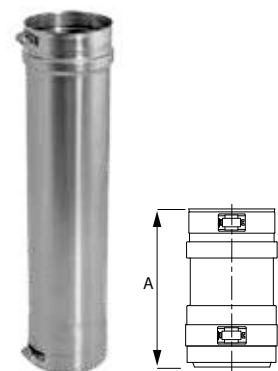

SIZE	ORDER #	STOCK #	A
4"	FSA-SMITH4	810004064	18"

Triangle Delta Series Appliance Adapter

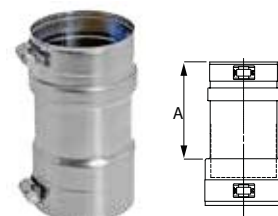

SIZE	ORDER #	STOCK #	A
3"	FSA-TR3	810004065	4"

Thermal Solutions Appliance Adapter



SIZE	ORDER #	STOCK #	A
6"	FSA-TS6	810004066	4 1/16"

Takagi TK-TV Series Termination Appliance Adapter



SIZE	ORDER #	STOCK #	A
4"	FSA-TTA4	810004067	3"

Weil McLain Ultra Series Appliance Adapter



SIZE	ORDER #	STOCK #	A
3"	FSA-ULT3	810004068	3 3/8"
4"	FSA-ULT4	810004069	3 3/8"

Columbia LVGD Series Appliance Adapter

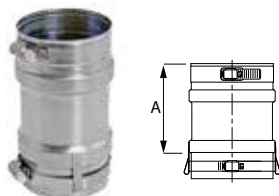

SIZE	ORDER #	STOCK #	A
3"	FSA-UTC3	810004073	4 1/2"
4"	FSA-UTC4	810004074	4 1/2"

Viessmann Vitoden Series Appliance Adapter

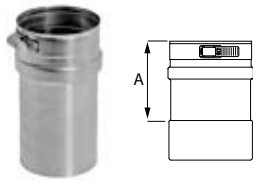

SIZE	ORDER #	STOCK #	A
3"	FSA-V3	810004075	3"
4"	FSA-V4	810004076	3"

Weil McLain GV Model Appliance Adapter

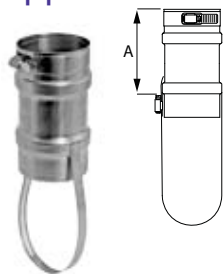

SIZE	ORDER #	STOCK #	A
3"	FSA-WEIL-GV3	810004070	4 1/2"

Weil McLain Tee Appliance Adapter

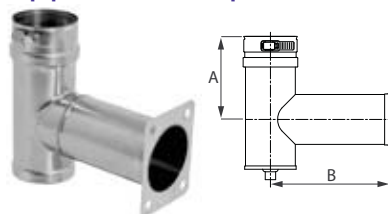

SIZE	ORDER #	STOCK #	A	B
3"	FSA-WEIL-GVTEE3	810004071	5"	7 3/16"

Weil McLain CG Series & Williamson Thermoflow GWI Series Appliance Adapter



SIZE	ORDER #	STOCK #	A
3"	FSA-WM-CG3	810004072	3"

Fulton Muffler Inlet Muffler

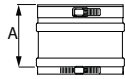

SIZE	ORDER #	STOCK #	A
4"	FSAAM4	810004077	5 7/16"
6"	FSAAM6	810004078	5 7/16"

Female-to-Male Jeremias Muffler

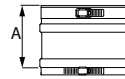

SIZE	ORDER #	STOCK #	A
7"	FSA-180F-7M	810004079	5 1/2"

Male-to-Female Jeremias Muffler

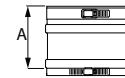

SIZE	ORDER #	STOCK #	A
7"	FSA-7F-180M	810004080	5 1/2"