

**WARNING!**

Improper installation, adjustment, alteration, service or maintenance can cause injury, loss of life or property damage. Refer to the installation and operating manuals. For assistance or additional information, consult a trained and certified installer, service agency or the gas supplier.

CAUTION!

The installation and operating manuals are part of the documentation that is delivered to the installation's operator. Go through the information in this manual with the owner/operator and make sure that he or she is familiar with the appliance and its operation.

NOTICE!

In the Commonwealth of Massachusetts this boiler must be installed by a licensed Plumber or Gas Fitter.

Logamax plus GB142

Table of Contents

1 Reference Documents	4
<hr/>	
2 Boiler Components & Controls	5
2.1 Periphery	6
2.2 Low Loss Header (LLH)	7
2.3 AM10 Outdoor Reset Modulating Boiler Control	9
2.4 RC35 Room Controller and User Interface	13
2.5 0-10V BMS Interface & Common Fault Module EM10	20
2.6 MCM10 Multi Cascade Module	21
<hr/>	
3 Sample Applications	25
Legend	26
3.1 System 1: Single boiler with outdoor reset, multiple heating zones with zone pumps and DHW	27
3.2 System 2: Single boiler with outdoor reset, multiple heating zones with zone relays and DHW	31
3.3 System 3: Single boiler with RC35, one heating zone, WM10 and DHW priority	35
3.4 System 4: Single boiler with RC35, WM10, SM10, one heating zone, & solar thermal DHW	39
3.5 System 5: Multi-boiler Cascade	43
<hr/>	
Appendix	47
Appendix 1 - Single boiler with 0-10V heat demand input	48
Appendix 2 - Multi-boiler cascade with 0-10V heat demand input	50
Appendix 3 - Adding DHW priority to a multi-boiler cascade	52

1 Reference Documents

The following table references all related documentation to the GB142 series boiler. To obtain copies of these documents, please go to our website at www.buderus.us.

Document Name	Description Of Contents
Installation Instructions	<ul style="list-style-type: none"> • Safety and general instructions • Product specifications • Installation • Electrical connections • Operation (start-up and shut down procedure)
Servicing Instructions	<ul style="list-style-type: none"> • Product description • Safety and general instructions • Operation • Symptoms • Diagnosis • Inspection / Maintenance
User's Instructions	<ul style="list-style-type: none"> • Safety information • Lighting instructions • Operating the BC10 basic controller • Boiler start-up and shut down • Operating and error messages
Record Book - Water Quality Requirements	<ul style="list-style-type: none"> • Requirements • Operator's log
Propane Conversion Kit Instructions	<ul style="list-style-type: none"> • Safety considerations • Parts list • Liquid Propane conversion • Operating instructions
Technical Service Bulletin: TBG-03_Removing Fan Assembly	<ul style="list-style-type: none"> • Service manual supplement • Replacement instructions
Technical Service Bulletin: TBG-04_Flue Gas Venting Requirements for Canada	<ul style="list-style-type: none"> • ULC S636 venting standard for Canada
Technical Service Bulletin: TBG-05_Guidelines for Venting Through Unconditioned Space	<ul style="list-style-type: none"> • Installation requirements for venting through unconditioned space
Technical Service Bulletin: TBG-06_Burner Removal & Installation	<ul style="list-style-type: none"> • Service manual supplement • Replacement instructions
Technical Service Bulletin: TBG-07_Boiler Water Chemistry & Freeze Prevention Guidelines	<ul style="list-style-type: none"> • Recommended steps for commissioning boiler • Water chemistry guidelines • Dielectric isolation • Cleaning requirements / Eliminating system leaks • Aluminum safe anti-freeze guidelines • Buderus selected suppliers of water treatment products
Technical Service Bulletin: TBG-08_Pressure Sensor Maintenance	<ul style="list-style-type: none"> • Problem statement and cause • Corrective action and work instruction
Technical Service Bulletin: TBG-10_Side Wall Vent Termination Spacing for Multiple Boilers	<ul style="list-style-type: none"> • Clearance guidelines - Stainless Steel concentric vents • Clearance guidelines - PVC concentric vents
Technical Service Bulletin: TBG-22_Condensate Tee Installation	<ul style="list-style-type: none"> • Location requirements • Installation requirements
Technical Service Bulletin: TBG-24_Vent Adaptor Change	<ul style="list-style-type: none"> • Notification of adaptor release • Benefits of adaptor
Technical Service Bulletin: TBG-27_High Limit Validation Procedure	<ul style="list-style-type: none"> • High limit test procedure

Table 1

2 Boiler Components & Controls

This chapter outlines the various components available with the GB142 series boiler along with the following control options:

- AM10 - Outdoor Reset Modulating Boiler Control
- MCM10 - Multi-boiler Cascade Module
- RC35 - Energy Management System (EMS) with Outdoor Reset, Room Reset, Zoning and Solar Thermal capabilities
- Logamatic 4000 Control System (see Logamatic 4000 Applications Manual)

This manual outlines the most common applications available using these components and controls. These application sections contain diagrams of preferred piping with associated wiring diagrams and controller programming, along with additional important information.

2.1 Periphery

2.1.1 Low Water Cut-off (LWCO) and External Manual Reset High Limit

National or local code may require the installation of an external Low Water Cut-Off (LWCO) and/or an External Manual Reset High Limit.

Notes:

1. Contractor to furnish and install LWCO and Manual Reset High Limit devices as required by local codes.
2. Do not install any type of valve or check valve in between boiler and LWCO or Manual Reset High Limit.
3. Refer to the manufacturer's instructions when installing LWCO and Manual Reset High Limit.
4. LWCO is installed external to the boiler and must be located above the highest point of the boiler heat exchanger.
5. Manual Reset High Limit remote sensing bulb must be located in the boiler supply.
6. In a cascade each boiler must be equipped with its own LWCO and Manual Reset High Limit.

Installation instructions (Fig. 1):

At the back of the boiler manifold remove the 1" plug and connect a 1" Tee. At the horizontal end connect a 1" well for the Manual Reset High Limit probe. At the vertical connector of the Tee, install a 1" stand pipe that reaches above the highest point of the boiler heat exchanger. Install a second Tee with an automatic air vent at the top and a LWCO just below.

Wire the LWCO and the Manual Reset High Limit normally closed dry contacts in series with EV pins 1 and 2 on the boiler, which will shut off the burner when the connection is interrupted.

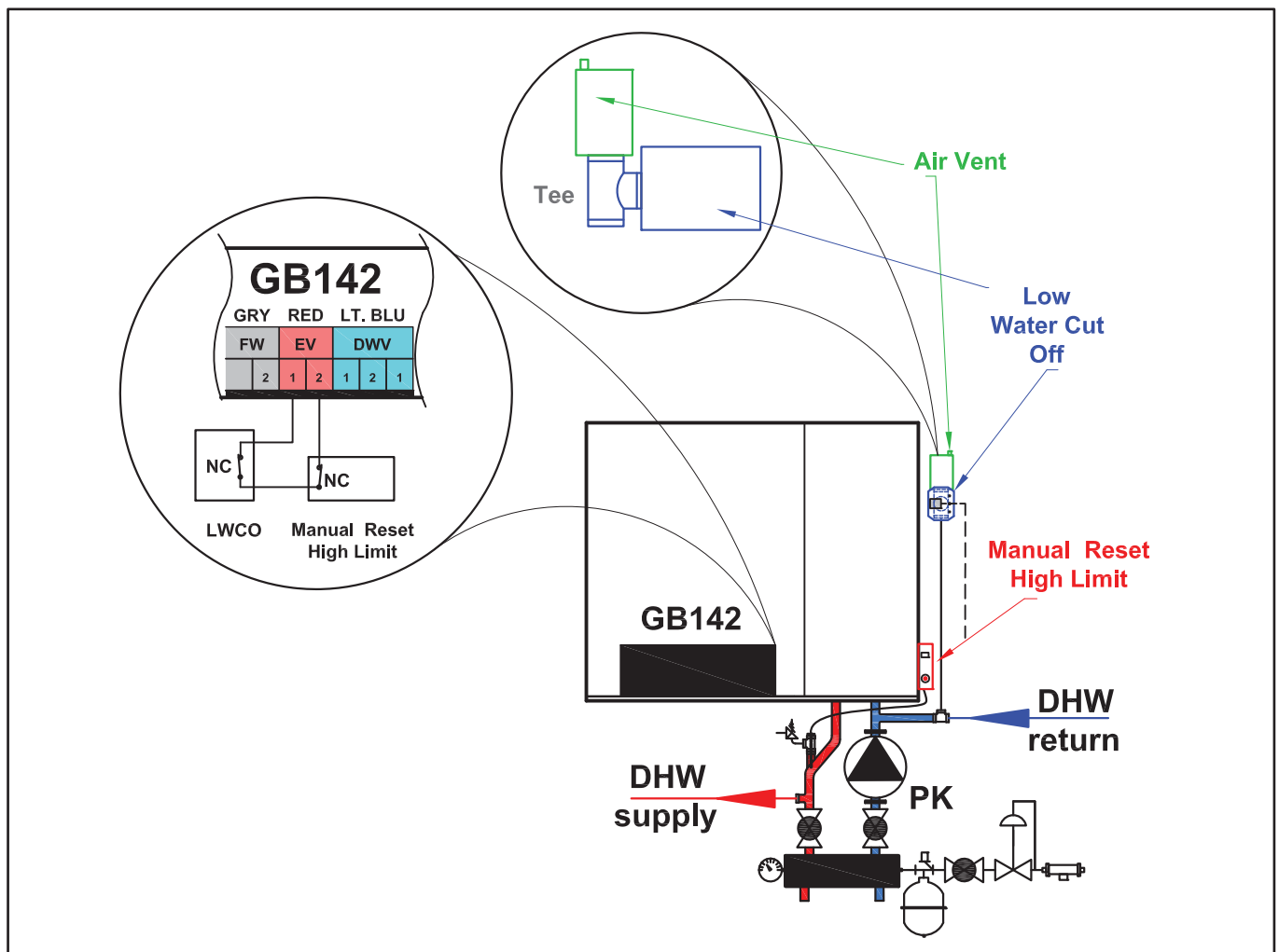

Fig. 1 Low Water Cutoff views

NOTE: Power supply to LWCO and external high limit not shown for clarity. Follow manufacturer's instructions.

Buderus

2.2 Low Loss Header (LLH)

2.2.1 General Information

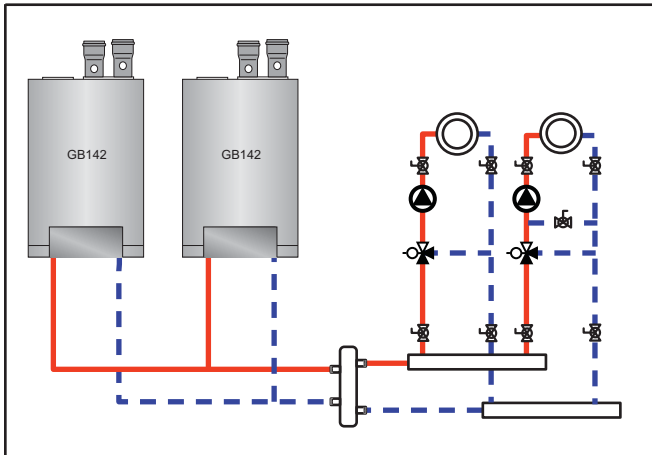

Fig. 2 Two Boiler System with Low Loss Header

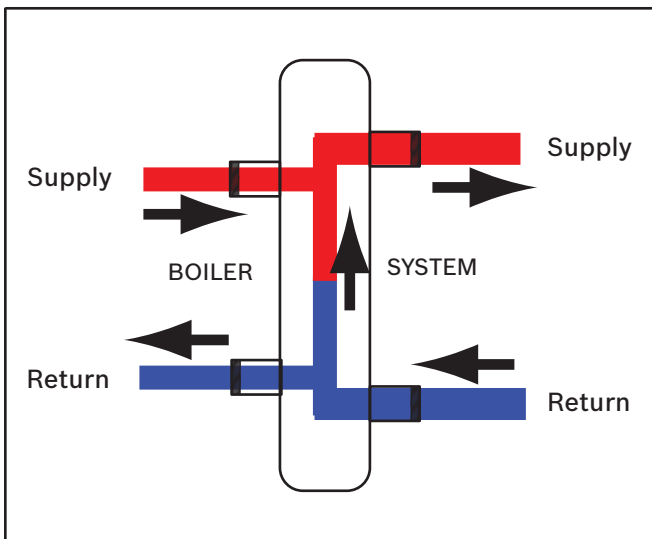

Fig. 3 Low Loss Header Overview

Modern compact wall hung gas appliances are often equipped with boiler controlled modulating pumps, some of which are also used for making DHW. These pumps are operating in ways that optimize boiler efficiency and longevity, but are not suitable for supplying the system at the same time. As a result the system must be set up with hydraulic separation between the primary and secondary sides.

A LLH is nothing more than a large pipe, installed between the heat sources and the system. It is used in single and multi boiler installations of appliances with small water volumes to independently control the flow of water in the boiler loop and the system loop.

When the circulating volumes between boiler loop and system loop differs greatly, a LLH can help avoid over flowing or under flowing one or the other. Over flowing can lead to noise and erosion in the piping, and can be identified by a boiler or system not coming up to temperature, or by a narrow delta T. Under flowing means that the heat is not being transported away from the boiler, causing it to bounce off the high limit.

In the system under flowing can result in too great a delta T, resulting in considerable heat being shed in the beginning of the loop and insufficient heat left for the remainder of the loop.

Installation of a LLH however requires a pump on the boiler side and one on the system side.

As their flow rates are typically low, some manufacturers design a LLH to include an air eliminator and dirt separator.

A typical example is a system with low mass boilers and multiple zones with zone pumps. The LLH ensures a constant flow rate through the boilers independently of how many zones are calling and independently of the flow rate in the system loop. It prevents pumps from working against each other, resulting in balanced flows, even heat distribution, and reduction of potential noise.

Possible scenarios of the LLH:

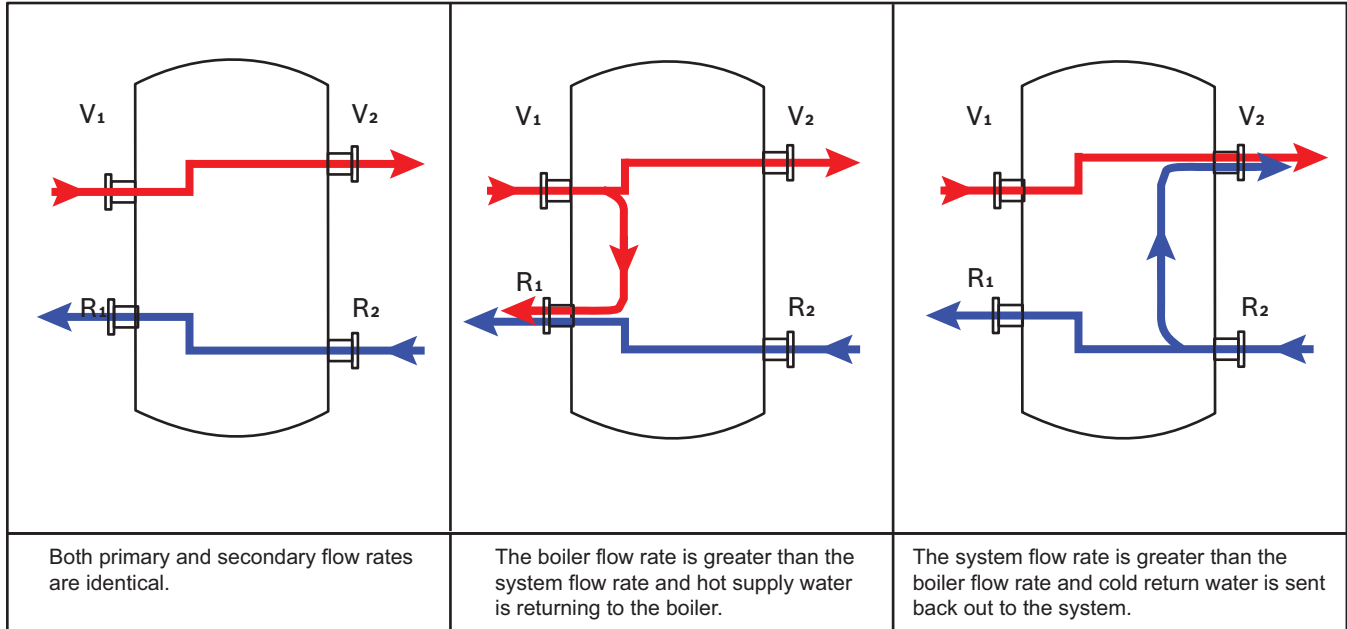

Fig. 4 Three possible flow patterns with a LLH

A LLH is typically equipped with a well for a system strategy sensor to measure supply water temperature. If this is not the case the system supply temperature sensor should be strapped onto the system supply pipe coming off the LLH.

A LLH is oversized to a point that it can handle the maximum possible flow rates on either side without significant pressure drop.

In the center of the LLH is the point of equilibrium and zero pressure. It allows for a variety of flow rates to occur on both sides of the system without influencing the other side.

A common case from retrofit applications: The system pumps are too strong and remove more water from the LLH than delivered by the boiler. With the consequence that none of the zones gets up to temperature. Required measure: reduce system flow rates.

For system redundancy, energy optimization, or combination of different fuel types, different boiler types or models may be combined in systems. Based on the load this allows turning off complete appliances resulting in higher efficiencies of the remaining system.

When a larger heat demand occurs additional boilers can be enabled one by one. The changing flow rates are balanced by the LLH and all boilers and zones in operation are continued to be supplied with the necessary volumes.

To ensure efficiency while also providing redundancy, each boiler must have its own boiler pump.

In particular when an existing system is retrofit with a new boiler it is necessary to evaluate the boiler and system flow rates. A reduction of boiler output can in many cases reach 40% and completely change system hydraulics.

Buderus

Example:

Old boiler output 480 MBH (140 kW)
New boiler output: 340 MBH (100 kW)

The new system requires a system flow rate of 19 gpm (4300 liters/hr) at 36°F (20°C) delta T.

As older systems are typically equipped with oversized pumps, the retrofit system can be expected to use pumps that may be half the size of the old ones. In this case only a LLH allows balancing of the primary and secondary flow rates. It is recommended to use multi speed or ECM pumps.

Sizing a Low Loss Header

Size the pumps and LLH by the greater of the two volumes that is circulating: boiler circuit or system circuit.

Note: It is recommended to set the minimum delta T between boiler supply and boiler return to 20 to 25°F (10 to 15°C) by adjusting the speed of the circulator or installing flow setters.

For sizing a LLH at maximum throughput the flow rate should not exceed 0.67 feet/second (0,2 m/s). This makes the LLH the area of slowest velocity and allows it to be used as an air separator and dirt separator.

Over sizing a LLH however does not have negative consequences on the system. In fact a buffer tank can be used instead of a LLH.

2.3 AM10 Outdoor Reset Modulating Boiler Control

Product Description

The AM10 is a modulating outdoor reset control for Buderus boilers equipped with the EMS bus. It sets the supply water temperature based on outdoor temperature. The boiler fires, runs and modulates based on the information received from the AM10, taking into consideration the delta T between supply and return.

An ON/OFF signal from a third party room thermostat or zone controller (not included) is used to communicate a heat demand. The AM10 offers warm weather shutdown (WWSD) when the outdoor temperature rises above a custom settable temperature (default: 70°F (21°C)).

To control and stage multiple boilers, combine the AM10 with an MCM10 cascade module.

Outdoor reset

Outdoor reset is a way to economically control space heating based on the outdoor temperature. It functions based on the fact that the colder the weather the greater the heat loss of a structure, and the higher the supply water temperature needed to heat the house. On a warmer day with smaller heat loss a lower water temperature will be able to heat the house. This has several advantages:

1. Save fuel by running the boiler at lower temperatures which reduces the heat going up the chimney.
2. Lower water temperatures allow taking advantage of the energy trapped in the flue gases (latent heat) in a condensing appliance.
3. Added comfort because temperature changes are not felt with lower water temperatures running constantly.

To achieve these goals the reset curve must be properly adjusted to match the application and the heat loss of the structure. The reset curve tells the boiler what water temperature is needed at a certain outdoor temperature.

Outdoor reset is the preferred control when using multiple zones, as the boiler supply water temperature is not dictated by a master or largest zone, but solely based on the heat loss of the structure.

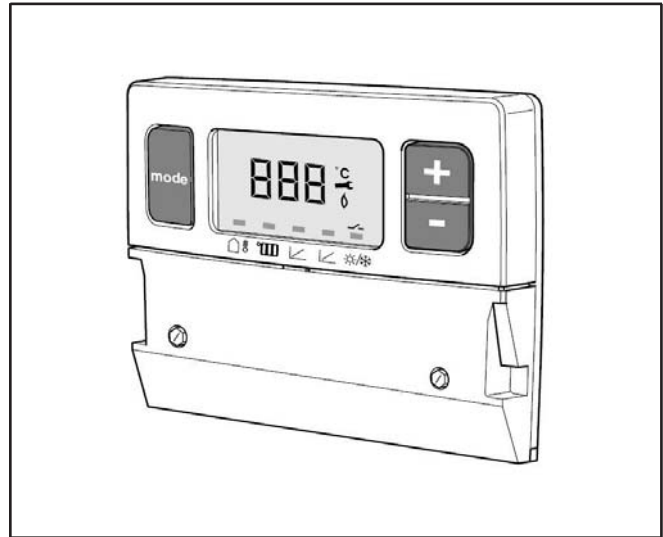

Fig. 5 AM10 Modulating Control

Heating curve

The AM10 has a built in linear heating curve that sets the supply water temperature in relation to the outdoor temperature. Top of heating curve represents the water temperature at 14°F (-10°C) outdoor temperature. Based on type of heating system different water temperatures are recommended for bottom of heating curve. The boiler follows the heating curve in the AM10 up to the maximum supply water temperature set on the boiler dial which works as a high limit (in cascades always set to AUT). In addition to the warm weather shut down (WWSD) turns the heating system off when the temperature outdoors rises above a certain value.

Heating curve chart in Degrees Fahrenheit:

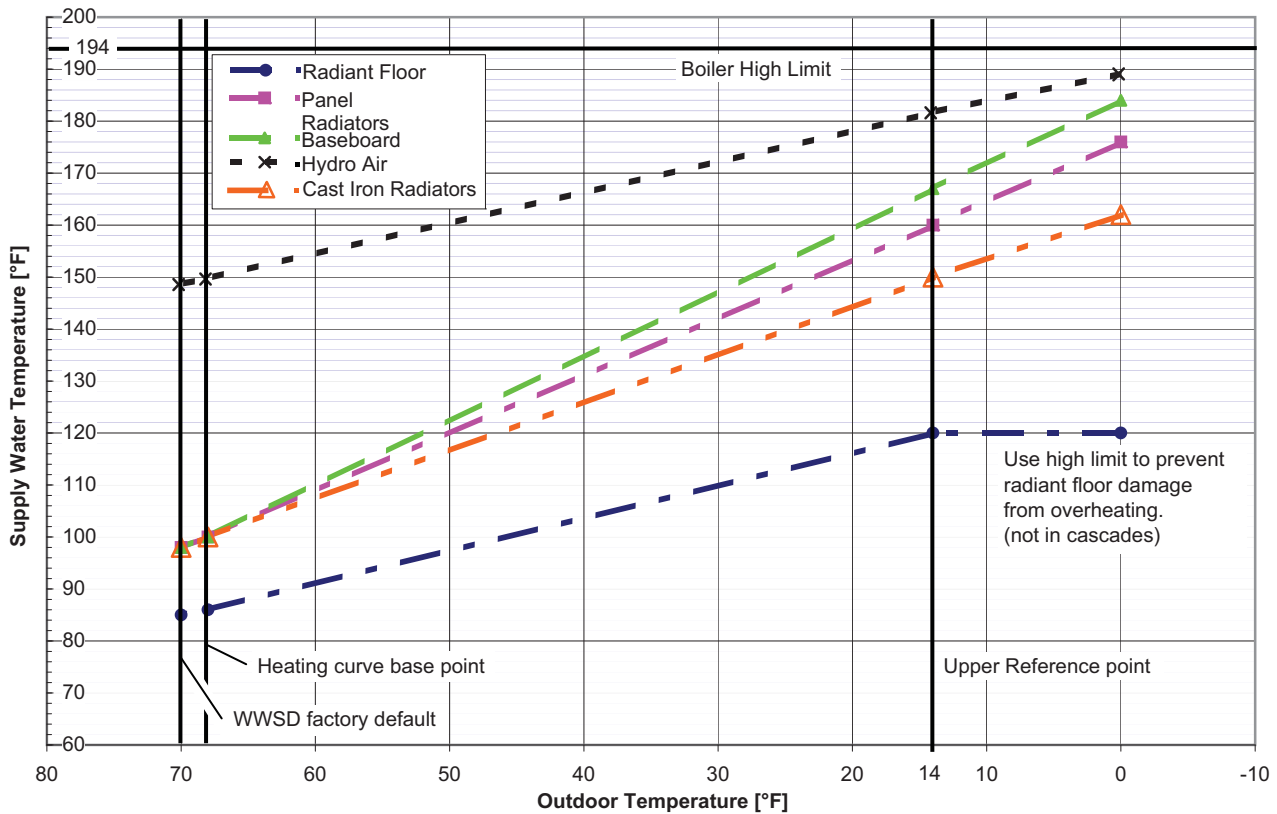

Fig. 6 Heating curve chart in Degrees Fahrenheit

	Outdoor Temperature	Radiant Floor	Panel Radiators	Cast Iron Radiators	Baseboard	Hydro Air
(°F)	0	120	176	162	184	190
	14	120	160	150	167	182
	68	86	100	100	100	150
	70	85	98	98	98	148

Heating curve chart in Degrees Celsius:

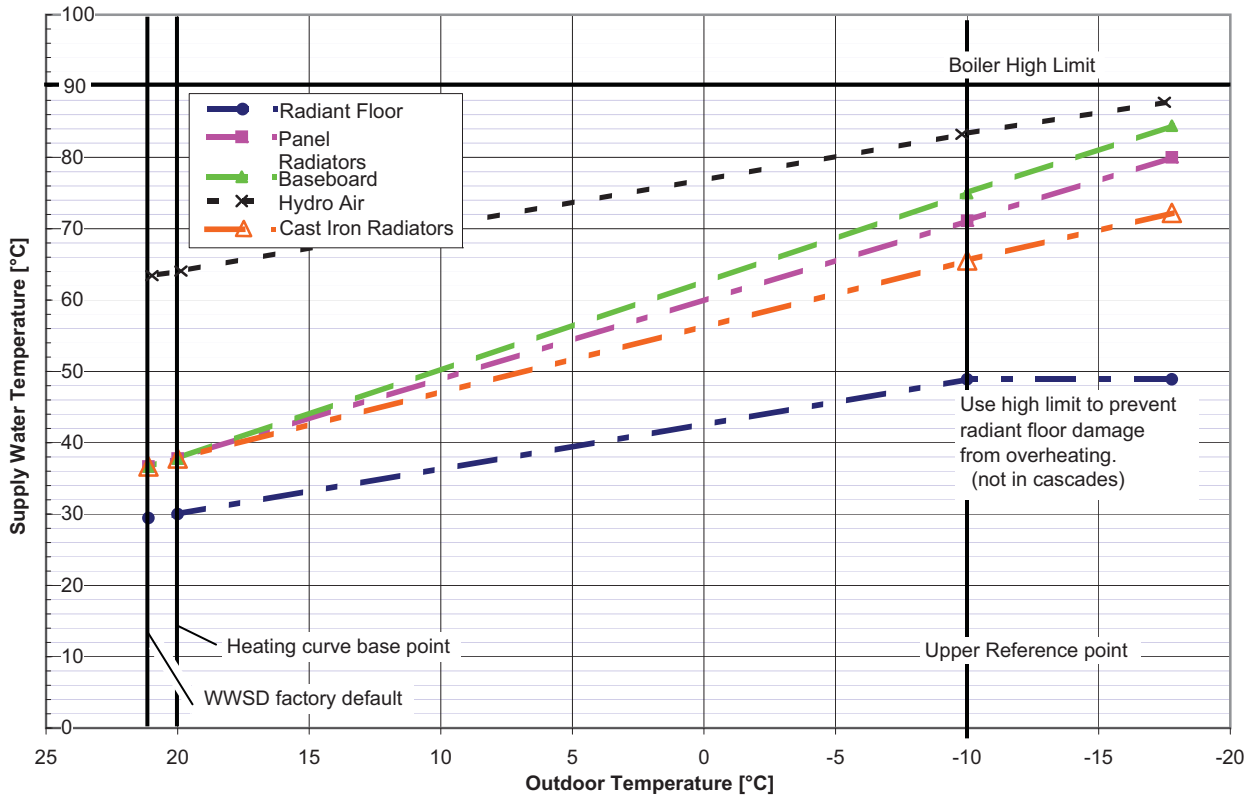

Fig.7 Heating curve chart in Degrees Celsius

	Outdoor Temperature	Radiant Floor	Panel Radiators	Cast Iron Radiators	Baseboard	Hydro Air
(°C)	-18	49	80	72	84	88
	-10	49	71	66	75	83
	20	30	38	38	38	65
	21	29	37	37	37	64

WWSD

Warm weather shut down (WWSD) temperature is factory set for 70°F (21°C). If the outdoor temperature rises above this setting, the boiler will be turned off except for generating DHW. The value can be adjusted between 32°F (0°C) and 86°F (30°C).

Mounting of the AM10

The recommended mounting locations are either on the wall next to the boiler or on the boiler jacket. A mounting bracket is included with the controller.

Positioning the outdoor sensor

For best performance the outdoor sensor is to be positioned at a location where it is not influenced by sunlight. Mount only on a North facing wall of the building, and at least 1 foot above snow line. Keep the sensor away from heat sources such as a dryer, water heater, or boiler vents, windows, etc.

Single Boiler Control

To equip a single GB142 boiler with outdoor reset control, the following items are recommended: (not included)

- ON/OFF thermostat for each heating zone
- Pump relay or zone valve panel according to the number of zones
- Low and high voltage wiring, 24VAC transformer, etc.

Wiring Details:

If there are multiple zones, wire all closed contacts to the AM10 so that each call for heat produces a heat demand.

Set the BC10 central heating dial to automatic (AUT), unless the system consists exclusively of low temperature radiant, where the central heating dial can be used as a high limit protection. In cascades the AUT setting is required.

Note: Do not install an RC10, EM10, or RC35 when using this configuration as these devices do not coexist with the AM10. For multi-boiler systems add the MCM10 cascade module between the AM10 and the boilers.

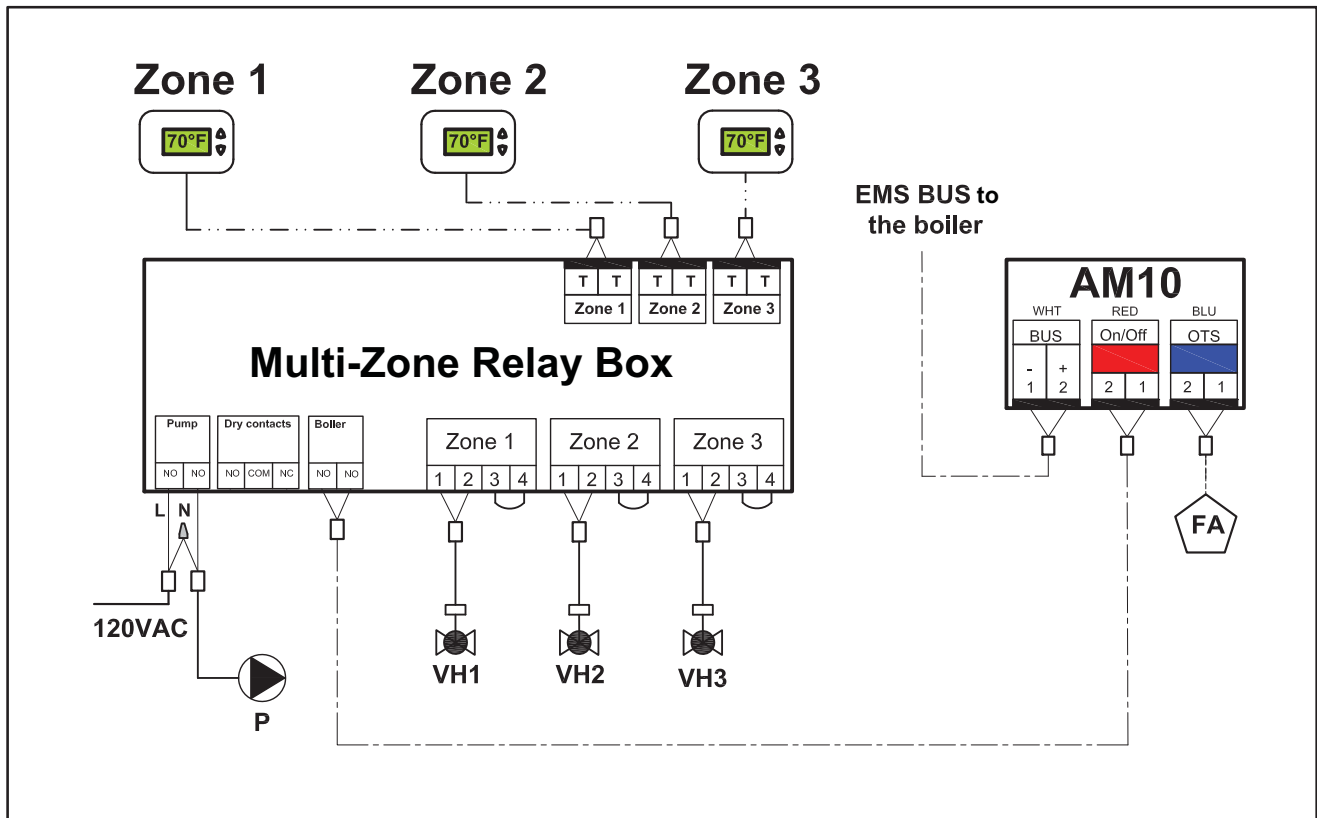

Fig. 8 Installation example with zone relay box

2.4 RC35 Room Controller and User Interface

The RC35 is an outdoor reset based heating system control with room influence and optional solar thermal DHW generation capability.

2.4.1 Features and benefits

Control features

- Outdoor reset
- Room reset or room influence
- Setback options
 - Room setback
 - Night setback
 - Outdoor setback
 - Shut-down
- 8 pre-loaded time programs with option to create custom program
- System Efficiency
 - Microprocessor coordinates boiler operation to ensure maximum comfort with optimized energy usage
 - Adjustable warm weather shut down (WWSD)
 - Room influence setting to prevent zone overheating
- Monitoring
 - Monitoring of system data including operating hours and burner starts
 - Solar thermal gain monitoring in combination with SM10 module
- User friendly
 - Easy to use due to LCD display with full text
 - Relay testing for start-up, commissioning and troubleshooting to verify proper wiring
- Service information
 - Service and diagnostic system simplifies troubleshooting
 - Maintenance reminder feature alerts the operator when servicing is due
- Modular structure of the control system allows customizing for many applications
 - Up to 4 heating zones (3 mixed, 1 unmixed) using 3 MM10 - Mixing Modules
 - Solar thermal integration for DHW generation using SM10 - Solar Thermal Module
 - Integration of a low loss header using WM10 - Low Loss Header Module
 - Cascade up to 16 boilers using up to 4 MCM10 - Multi-Boiler Cascade Modules.
 - DHW preparation including control of a DHW recirculation pump

2.4.2 Overview

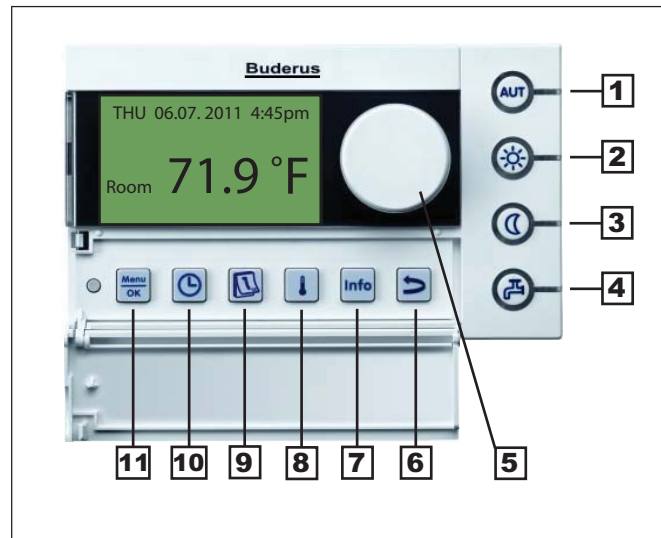
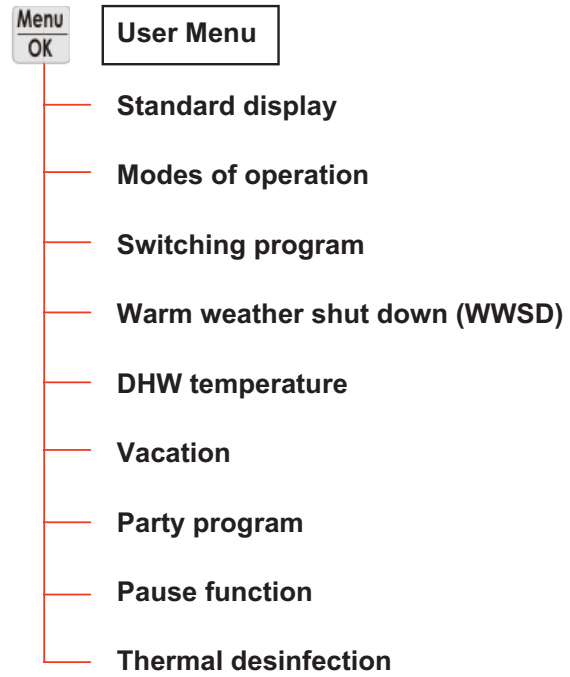
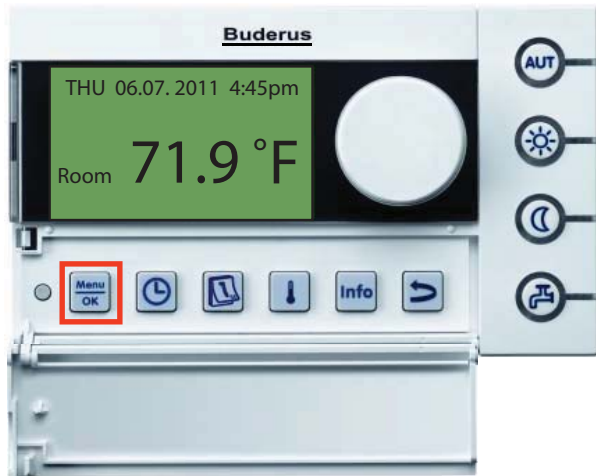

Fig.9 Description of the RC35 room control

- 1: Automatic mode (switching program)
- 2: Continuous heating (day temperature)
- 3: Permanently reduced (night temperature)
- 4: DHW single charge button
- 5: Change temperature temporary
- 6: Back
- 7: Show data
- 8: Set day or night temperature
- 9: Set current date
- 10: Set current time
- 11: Open User menu

2.4.3 RC35 room control programming aspects

User menu:



Service menu:

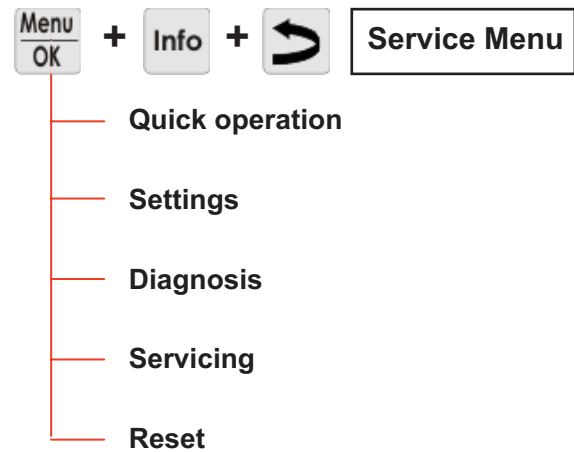
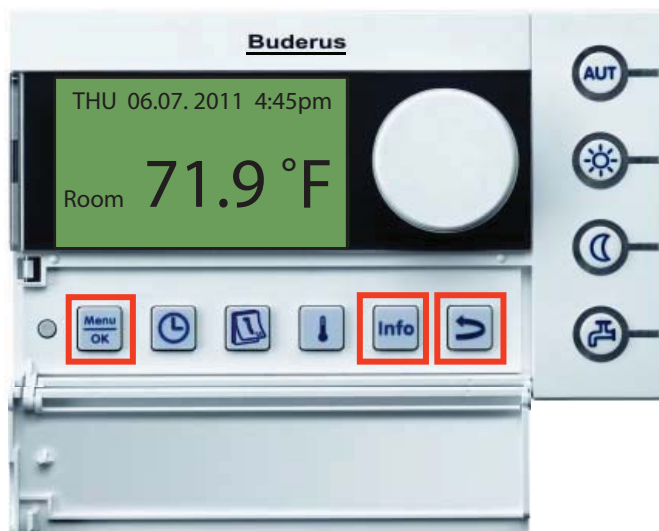

2.4.4 RC35 wiring diagrams

The RC35 user interface can be installed in a reference room to utilize the internal thermostat for room reset, or in a dedicated bracket in the boiler if room influence is not required.

Mounting the RC35 in the room and utilizing its internal room sensor:

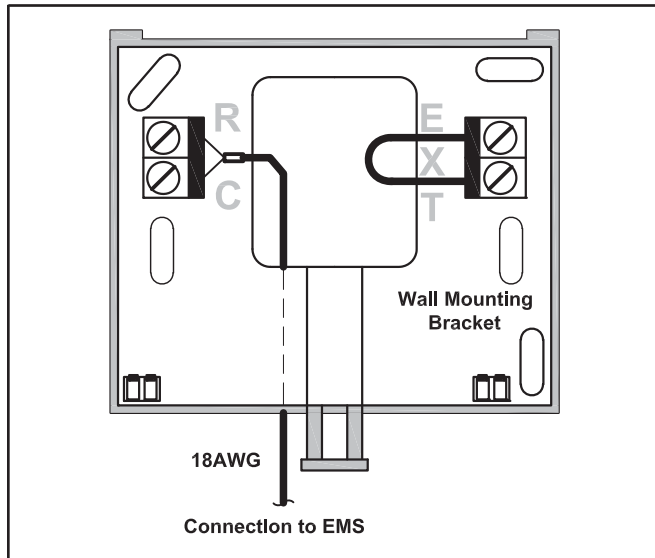

Fig.10 RC35 wiring using its internal room sensor

Mounting the RC35 in the room and utilizing a remote room sensor (part number: 5 993 226):

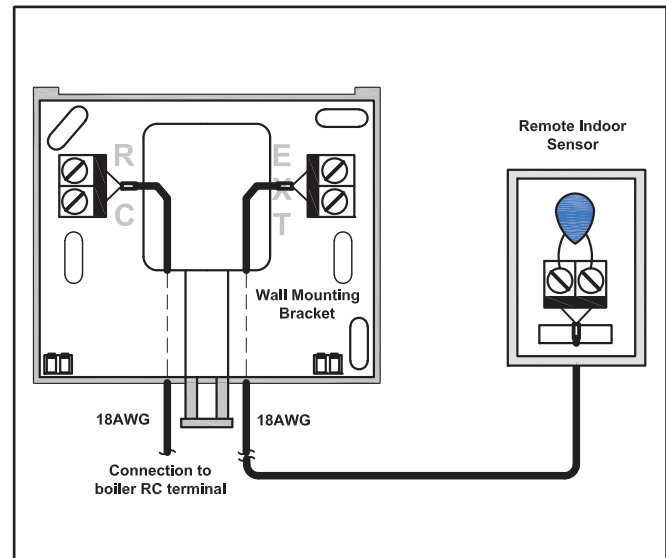

Fig.11 RC35 wiring using its remote room sensor

2.4.5 EMS modules for RC35

Single Mixed Heating Zone Module MM10

This module is needed to operate a mixed heating zone pump and motorized mixing valve. The RC35 can control up to 3 MM10 modules per system.

Features of the MM10:

- Room reset, outdoor reset, outdoor reset with room influence.
- Keyed and color coded connecting plugs
- Sends a quantified heat demand to the boiler
- Mounting: In the boiler or on the wall
- LED indicator for mode of operation
- Up to 3 modules per heating system
- Uses the RC35 user interface
- 120V supply
- Each module allows it's own temperature zone and timer program
- Selectable set back options for each individual zone
- Anti-freeze protection per zone
- Pump anti-seize function
- Input: 1 x Heating Zone Supply Sensor
- Outputs: 1 x Heating Zone Pump 120V
1 x 3-way Floating Mixing Valve 120



Fig.12 Single Mixed Heating Zone Module MM10

Unmixed Heating Zone & Low Loss Header Module WM10

The WM10 has two functions:

1. Runs one unmixed heating zone
2. Controls the hydraulic separation between the boiler loop and system loop in systems with a low loss header (LLH)

Features of the WM10:

- In an unmixed heating zone a separate timer program can be selected.
- Keyed and color coded connecting plugs
- Communication with EMS boiler-data bus
- Mounting: In the boiler or on the wall
- LED indicator for mode of operation
- 1 module per heating system
- 120V supply
- Input: 1 x Heating Zone Supply Sensor or System Supply Sensor
- Output: 1 x Heating Zone Pump 120V or System Pump 120V



Fig.13 Unmixed heating zone and Low loss header Module WM10

Solar Thermal DHW Module SM10

The SM10 Module integrates a Solar Thermal DHW system with an EMS boiler system which provides significant energy savings for DHW generation. The integrated system knows when solar energy is available and reduces boiler run time and boiler starts.

Features of the SM10:

- Keyed and in color coded connecting plugs
- Communication with EMS boiler-data bus
- Mounting: In the boiler or on the wall
- LED indicator for mode of operation
- 1 module in a heating system
- Solar pump modulation 20-100% to maximize solar gain
- 120V supply
- Input: 1 x Collector Sensor
1 x Solar Tank Sensor (Bottom)
- Outputs: 1 x Solar Thermal Pump 120V



Fig.14 Solar Thermal DHW Module SM10

2.4.6 Mixing Module MM10 Wiring Diagram

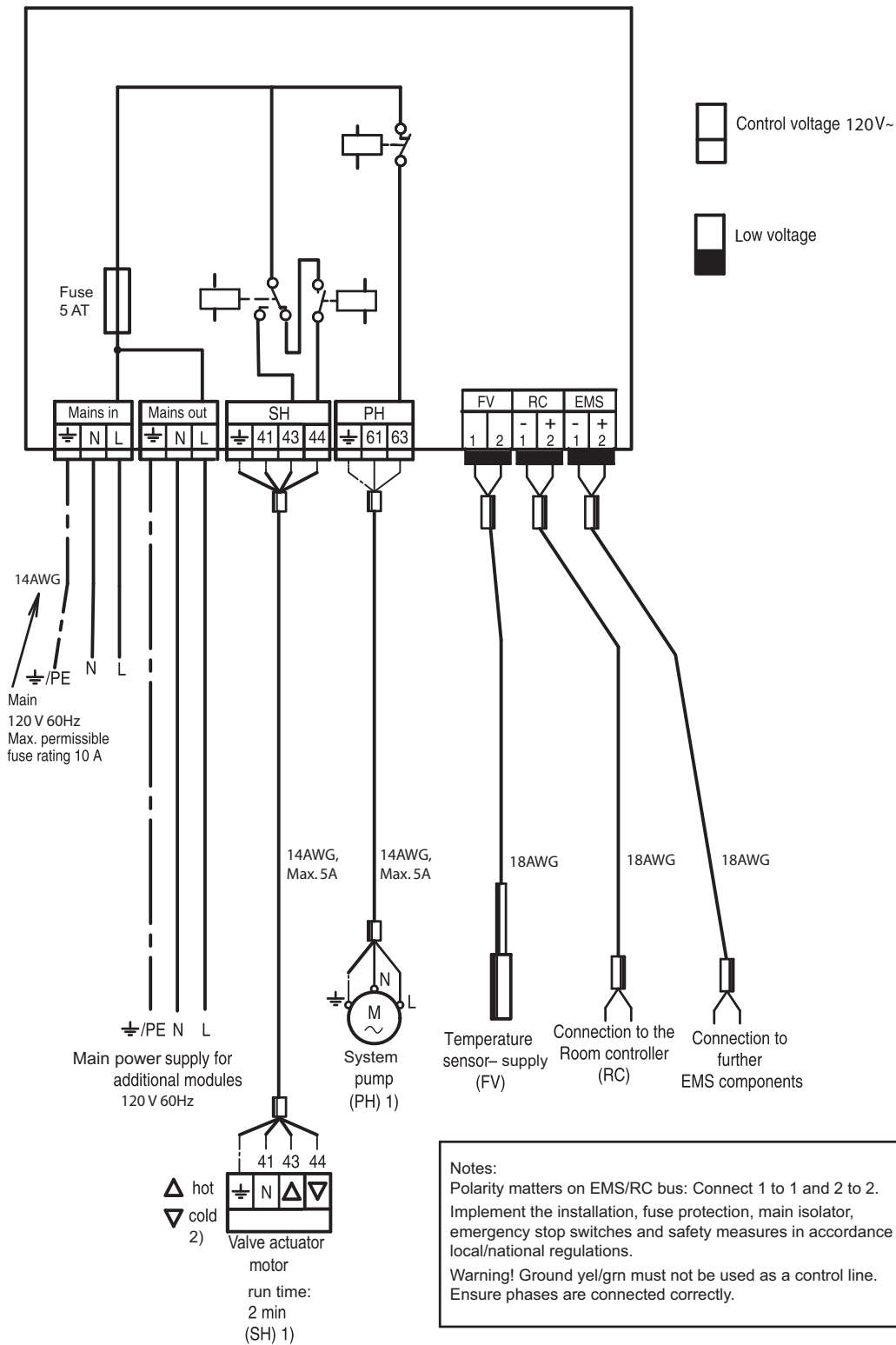

- 1) Requires 120V mixing valve with 3-point floating actuator. Maximum current: 5A
- 2) Hot: increase hot water delivery to zone
Cold: decrease hot water delivery to zone

2.4.7 WM10 - System or Low Loss Header Module Wiring Diagram

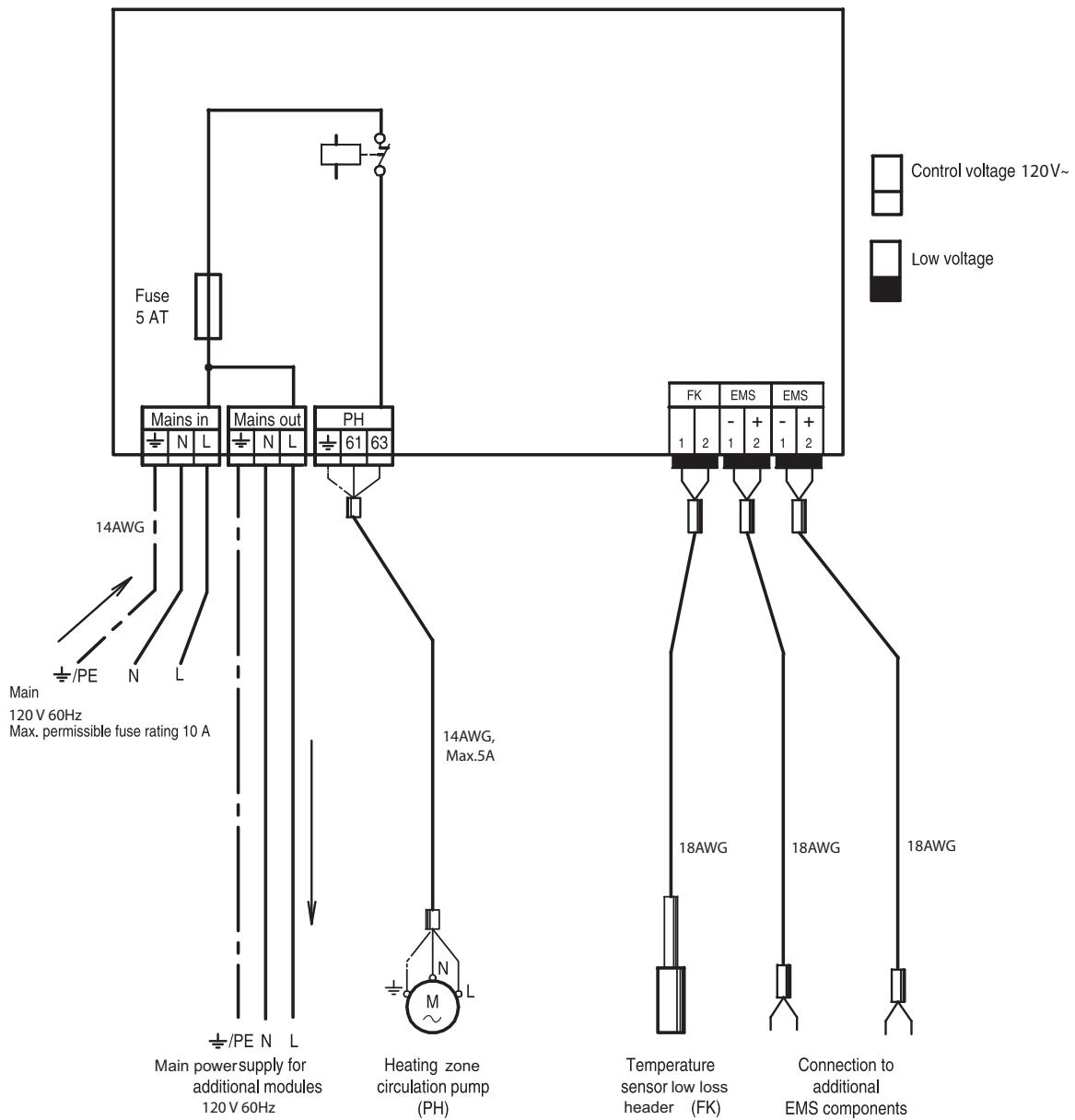

Notes:
 Polarity matters on EMS/RC bus: Connect 1 to 1 and 2 to 2.
 Implement the installation, fuse protection, main isolator, emergency stop switches and safety measures in accordance with local/national regulations.
 Warning! Ground yel/grn must not be used as a control line.
 Ensure phases are connected correctly.

2.4.8 Solar Module SM10 Wiring Diagram

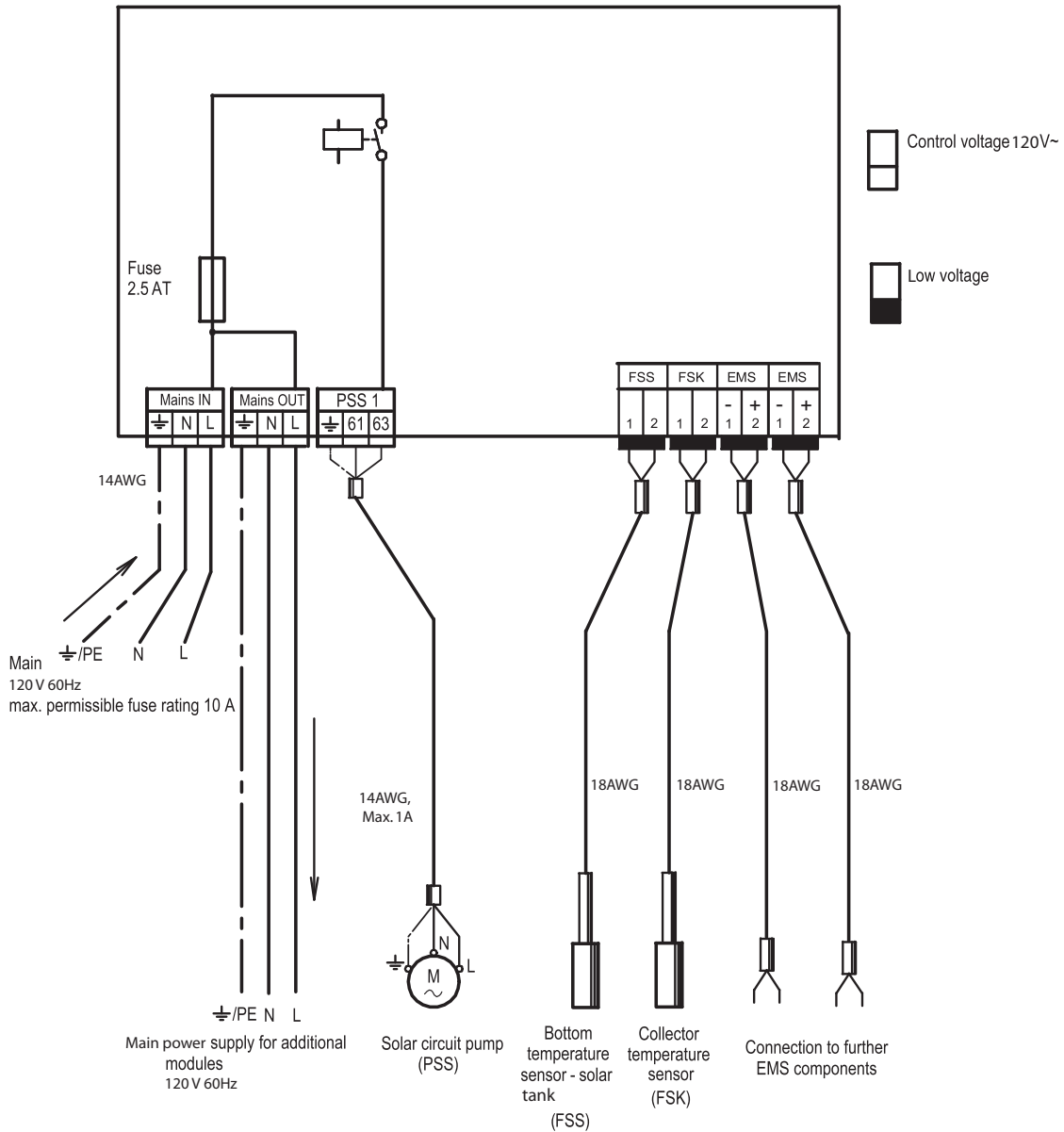

Notes:
 Polarity matters on EMS/RC bus: Connect 1 to 1 and 2 to 2.
 Implement the installation, fuse protection, main isolator, emergency stop switches and safety measures in accordance with local/national regulations.
 Warning! Ground yel/grn must not be used as a control line.
 Ensure phases are connected correctly.

2.5 0-10V BMS Interface & Common Fault Module EM10

The EM10 Module allows interfacing a single boiler with a Building Management System (BMS) for temperature or output setpoint control. The EM10 also has a dry set of N/O and N/C contacts that can be used to trigger a system alarm.

Features of the EM10:

- Run single boiler based on BMS input 0-10V signal for temperature or output setpoint control
- Input: 0-10V
- Common fault dry contact output NO/NC
- 120V supply



Fig.15 EM10 0-10V BMS Interface Module

2.6 MCM10 Multi Cascade Module

The MCM10 - Multi Cascade Module allows running and staging multiple boilers in a cascade system.

Each MCM10 controls up to 4 boilers, and with 4 modules in a system, up to 16 boilers can be controlled.

The MCM10 can only be used with boilers that have the EMS-BUS (UBA3, UBA3.5).

Boilers of any size can be connected in the cascade system as long as they are EMS-BUS compatible.

2.6.1 System Integration

The MCM10 stages the boilers within the cascade system based on a heat demand from one of the following sources:

- 0-10V BMS input directly to the MCM10
- W-A dry contact input directly to the MCM10
- AM10 outdoor reset controller with dry contact input
- RC35 energy management system

The MCM10 controls the system supply temperature, which requires a system supply temperature sensor strategically placed.



Fig.16 Multi Cascade Module (MCM10)

2.6.2 MCM10 LED Functions

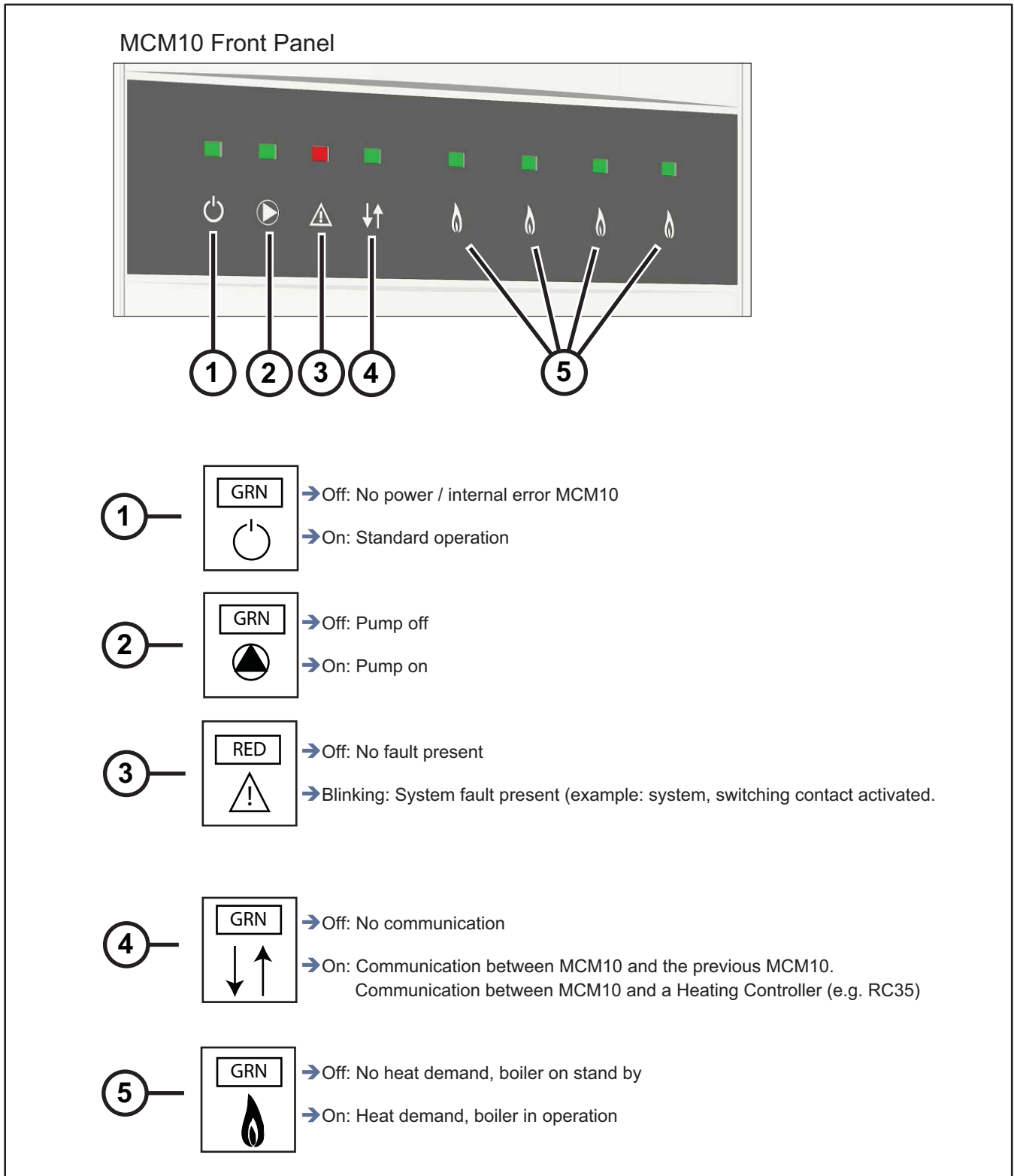

Fig.17 MCM10 LED functions

2.6.3 MCM10 Electrical Connection Diagram

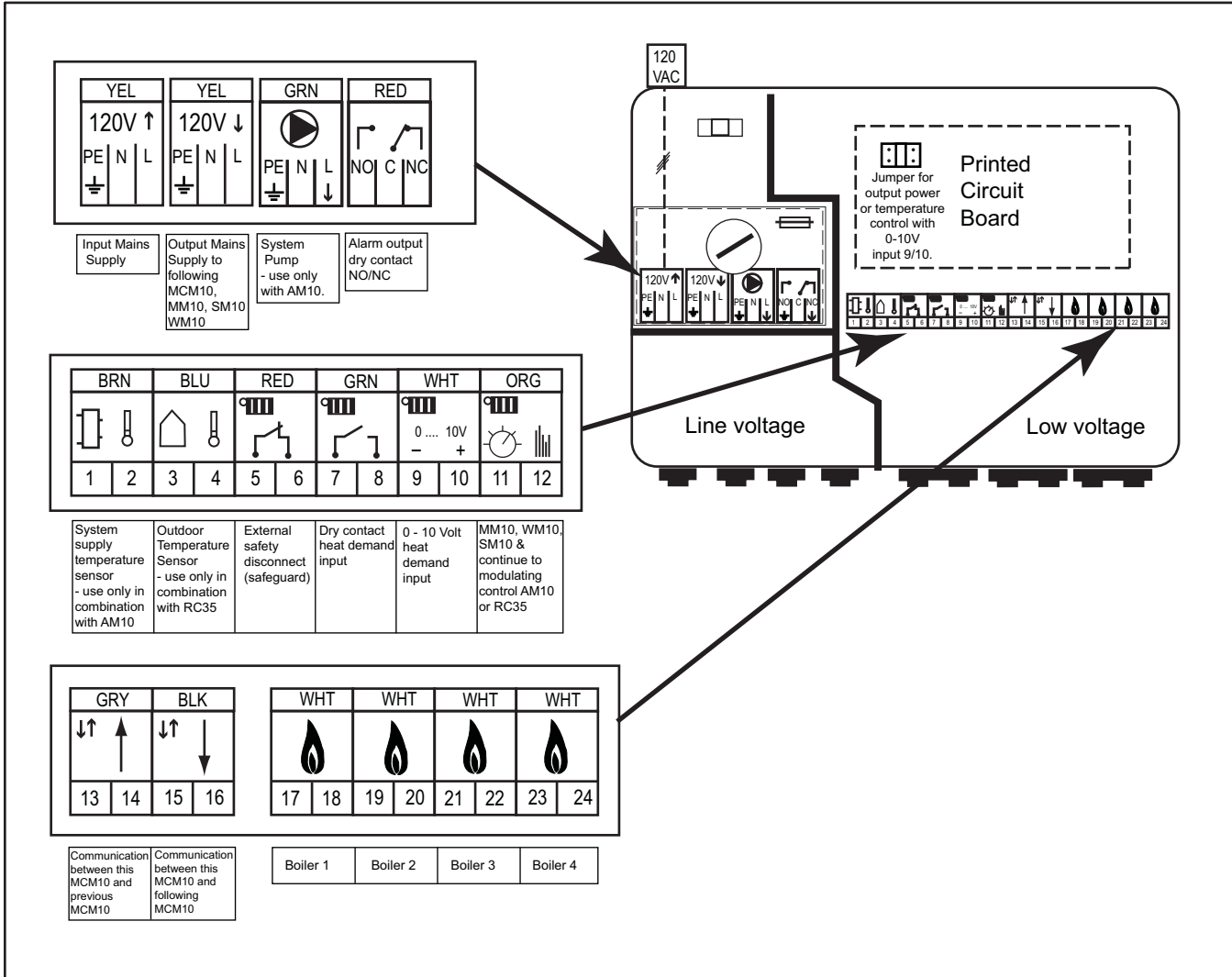

Fig.18 MCM10 connection diagram

2.6.4 MCM10 Configuration Options









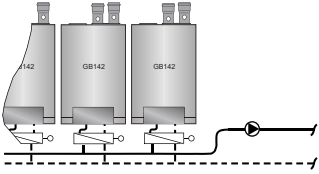
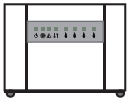
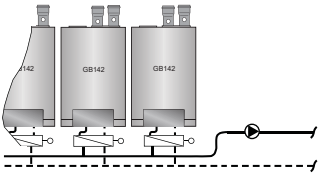
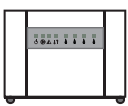
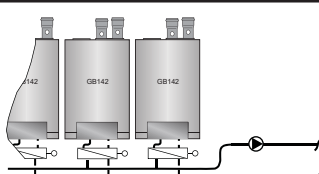
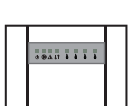

Configuration	Description	Controls			
	up to 16 GB142	 up to 4 MCM10	0-10V heat demand input from BMS		
	up to 16 GB142	 up to 4 MCM10	dry contact heat demand input		
	up to 16 GB142	 up to 4 MCM10			
	up to 4 GB142 1 heat circuit	 MCM10			
	up to 8 GB142 1 mixed and 1 unmixed heating zones	 2x MCM10			
	up to 12 GB142 2 mixed and 1 unmixed heating zones	 3x MCM10			 2x MM10
	up to 16 GB142 3 mixed and 1 unmixed heating zones	 4x MCM10			 3x MM10

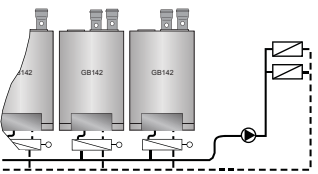
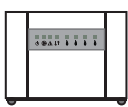
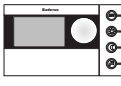
Fig.19 MCM10 Configuration Options

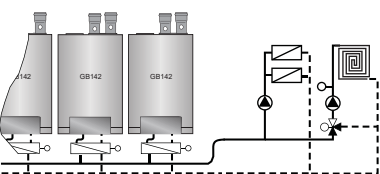
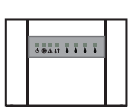
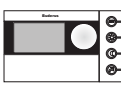
3 Sample Applications

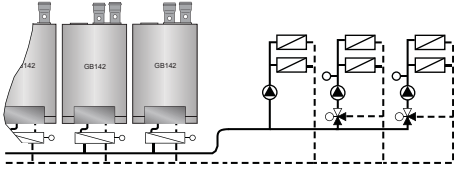
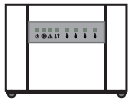
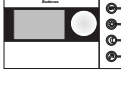
Legend	26
3.1 System 1: Single boiler with outdoor reset, multiple heating zones with zone pumps and DHW	27
3.2 System 2: Single boiler with outdoor reset, multiple heating zones with zone relays and DHW	31
3.3 System 3: Single boiler with RC35, one heating zone, WM10 and DHW priority	35
3.4 System 4: Single boiler with RC35, WM10, SM10, one heating zone, & solar thermal DHW	39
3.5 System 5: Multi-boiler Cascade	43

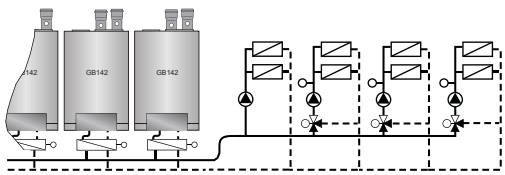
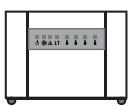
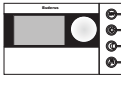
Legend

















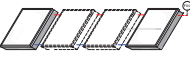









	High temperature zone (e.g. baseboard)		Return pipe
	Solar pump station		Supply pipe
	Distribution manifold		Purge station
	Solar thermal collector array		Expansion tank and PRV for solar thermal system
	GB142 boiler with LLH		Temperature gauge
	Indirect fired solar tank		Outdoor temperature sensor
	Indirect fired DHW tank		Room thermostat
	Temperature sensor		RC35 controller
	Pump		MCM10 multiboiler cascade module
	Feed line and expansion tank with air vent		Communication line
	Zone valve		Sensor line
	Check valve		Low voltage line (maximum 24V)
	Two way shut off valve		Line voltage line (120V)
	Safety relief valve		

Fig.20 Legend

NOTICE: All drawings in this manual are conceptual in nature and only depict components relevant for the systems shown. It is the installer's responsibility to know national and local code and install safety devices as required. Install and size peripheral devices such as air purge, expansion vessel, feeder valve, mud separator, shutoff valves, etc. per best installation practices. Contact Buderus with installation related questions.

Buderus

3.1 System 1: Single boiler with outdoor reset, multiple heating zones with zone pumps and DHW

Summary:

Single boiler supplying multiple heating zones equipped with 3rd party thermostats and zone pumps. This system is recommended if pressure drops in individual zones are too great to be served by a single system pump (see system 2).

- High efficiency outdoor reset controlled system based on heat loss of the structure
- Outdoor reset for system supply water temperature
- Zone pumps are controlled by 3rd party relay panel and individual room thermostats
- Optional DHW tank loading with or without priority

In detail:

The AM10 outdoor reset controller receives a heat demand from the zone thermostats via a closed contact and computes the system supply water temperature based on information from the outdoor sensor and the heating curve.

Applications include multiple zones at the same temperature, or zones at different temperatures if thermostatic or externally controlled motorized mixing valves are used.

The AM10 provides warm weather shutdown.

The modulating boiler strives to run at low fire for the longest time possible where efficiency is at its highest.

DHW is heated based on the signal from the DHW tank sensor FW. DHW is generated in parallel with space heating if both are calling simultaneously. For faster DHW recovery, install a relay that disables zone circulators while the tank loading pump is activated. Alternatively a zone relay panel with DHW priority can also be used.

The low loss header decouples the boiler loop from the system loop.

Required components:

- GB142 boiler
- AM10 controller (incl. with GB142)
- PH zone circulators
- PS DHW tank loading circulator
- ECM pumps (low energy or constant pressure pumps) are recommended for constant flow rate and additional energy savings.
- DHW tank
- Multi zone pump relay panel with/without DHW priority
- PS DHW tank loading circulator
- Zone thermostat per room/zone

Additional instructions:

See manufacturer's installation and operating instructions for details on 3rd party components.

The system shown generates DHW with priority over space heating.

If the DHW sensor in the tank reports a call for DHW, the boiler will ramp up the supply temperature according to the DHW setting overriding the outdoor reset heating curve.

The boiler has DHW priority built in. Use the DHW sensor with the DHW tank and select the DHW temperature using the boiler dial. During a DHW call the PS tank loading pump will run and the PK boiler pump will be off. Once DHW is satisfied the boiler will return to space heating.

If DHW is not installed, set the DHW dial to OFF.

Piping Diagram - System 1

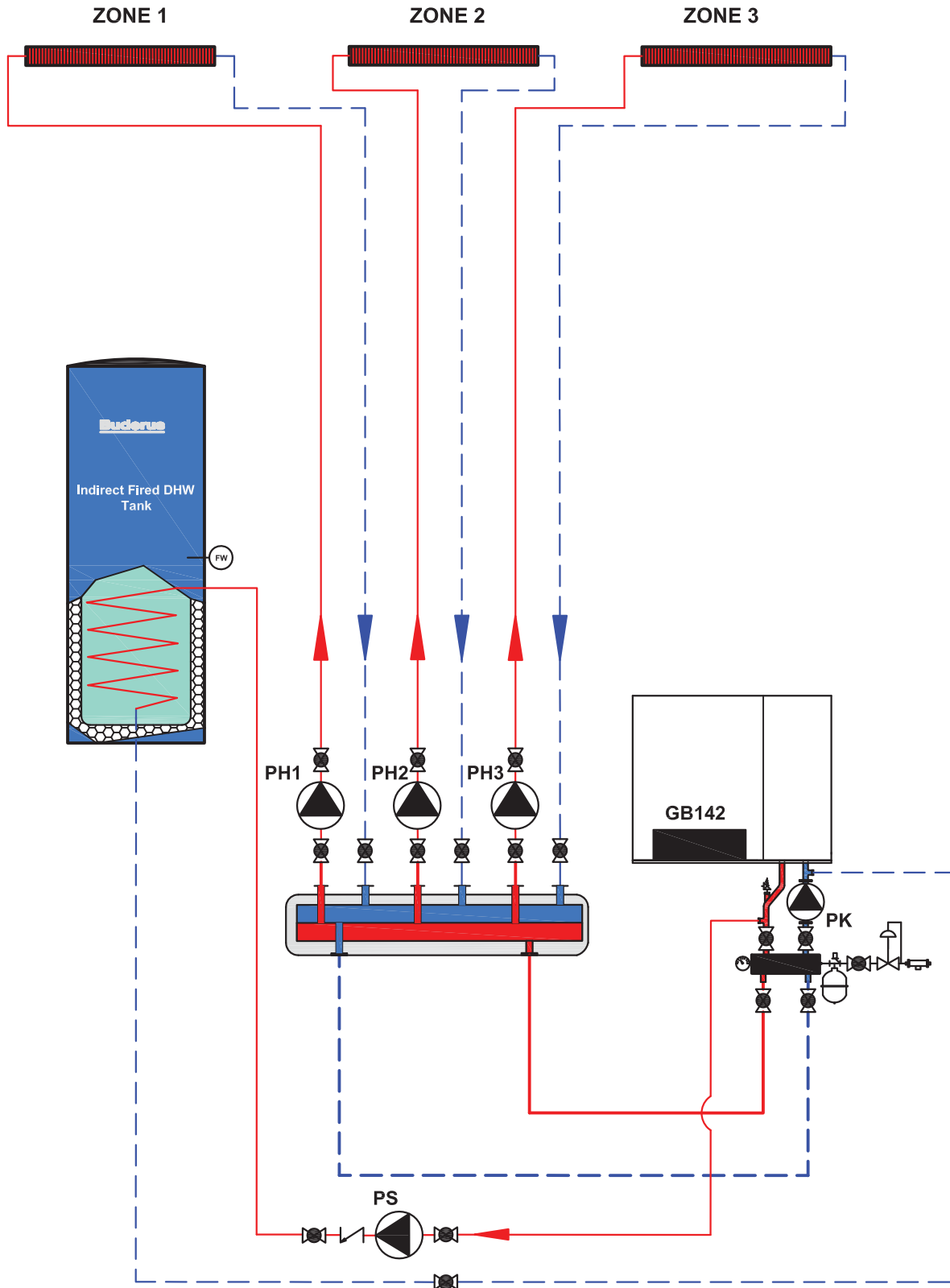

Wiring Diagram - System 1

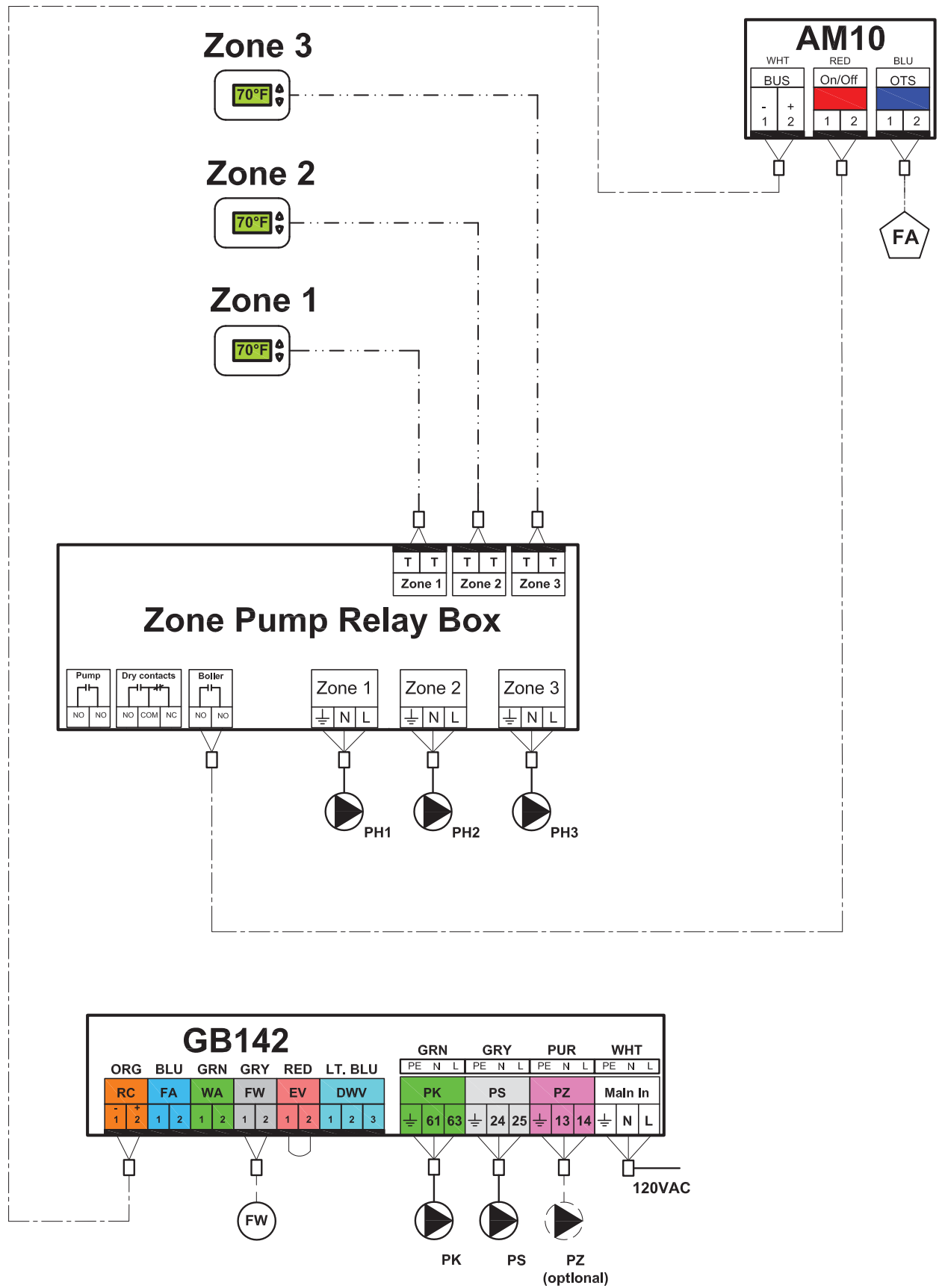

Programming - System 1

- When powering up the AM10 the current outdoor temperature is displayed (Fig. 21).
- Press the mode key to switch to the next menu item. On the screen a block will indicate the current step from 1 through 5.
- The second menu item is the current supply temperature computed based on the current outdoor temperature (Fig. 22).
- Press the mode key to switch to the next menu item.
- Define the heating curve by entering two distinct set points. (A) Supply water temperature at 14°F (-10°C) outdoor temperature (Fig. 23), and by pressing the mode key again, (B) supply water temperature at 68°F (20°C) outdoor temperature (Fig. 24).
- Press the mode key to switch to the warm weather shut down (WWSD) temperature (Fig. 25). If the outdoor temperature rises above this value space heating will stop.
- Pressing the mode key again will return the display to the current outdoor temperature (Fig. 21).

	Range	Factory Default
Supply water temperature at 14°F:	68 - 194 °F	167 °F
Supply water temperature at 68°F:	68 - 194 °F	86 °F
Warm weather shut down temperature:	32 - 86 °F	70 °F

See also chapter 2.3 for additional information on the AM10.

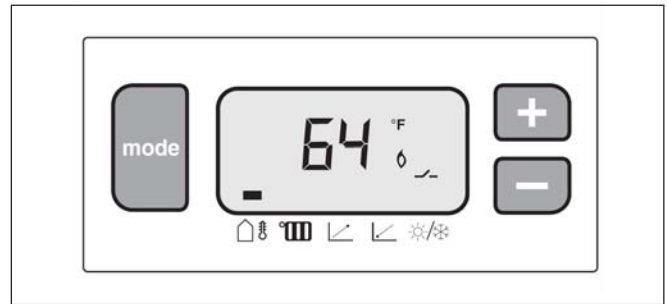

Fig.21 Default display: Current outdoor temperature

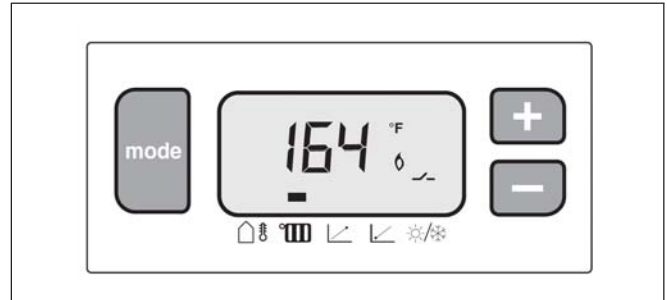

Fig.22 Current target supply temperature



Fig.23 Heating curve upper value (14 °F)

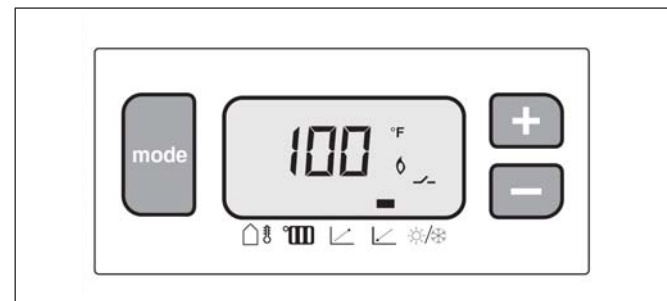

Fig.24 Heating curve lower value (68 °F)

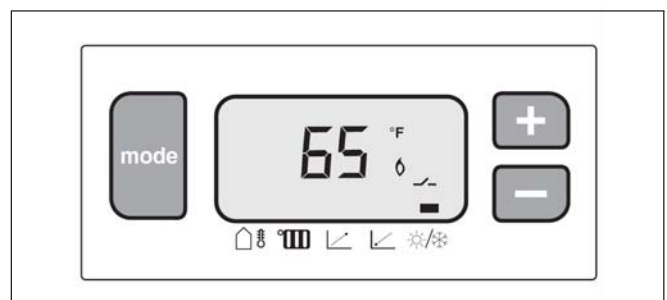

Fig.25 Warm weather shut down temperature

3.2 System 2: Single boiler with outdoor reset, multiple heating zones with zone relays and DHW

Summary:

Single boiler system with a system pump supplying multiple heating zones with 3rd party thermostats and zone valves. Use this design for systems with smaller pressure drops, e.g. baseboard and panel radiators, compared to system 1 which better handles radiant floors with high pressure drops that require a separate pump for each zone.

- Outdoor reset for system supply water temperature
- Zone valves are controlled by 3rd party relay panel
- DHW loading with or without priority
- High efficiency outdoor reset controlled system based on heat loss of the structure
- Automatic warm weather shut down (WWSD)

In detail:

The AM10 outdoor reset controller receives a heat demand via a closed contact and computes the system supply water temperature based on information from the outdoor sensor and the heating curve.

Applications include multiple zones at the same temperature, or zones at different temperatures if thermostatic or externally controlled motorized mixing valves are used.

The AM10 provides warm weather shutdown.

The modulating boiler strives to run at low fire for the longest time possible where efficiency is at its highest.

DHW is heated based on the signal from the DHW tank sensor FW. DHW is generated in parallel with space heating if both are calling simultaneously. For faster DHW recovery, install a relay that disables the zone circulator while the tank loading pump is activated. Alternatively a zone relay panel with DHW priority can also be used.

The low loss header decouples the boiler loop from the system loop.

Required components:

- GB142 boiler
- AM10 controller (incl. with GB142)
- Multi zone valve relay panel with/without DHW priority.
- PH system circulator
- PS DHW tank loading circulator
- ECM pumps (low energy or constant pressure pumps) are recommended for constant flow rate and additional energy savings.
- Zone valves
- Room thermostats

Additional instructions:

See manufacturer's installation and operating instructions for details on 3rd party components.

The system shown generates DHW with priority over space heating.

If the DHW sensor in the tank reports a call for DHW, the boiler will ramp up the supply temperature according to the DHW setting overriding the outdoor reset heating curve.

The boiler has DHW priority built in. Use the DHW sensor with the DHW tank and select the DHW temperature using the boiler dial. During a DHW call the PS tank loading pump will run and the PK boiler pump will be off. Once DHW is satisfied the boiler will return to space heating.

If DHW is not installed, set the DHW dial to OFF.

Piping Diagram - System 2

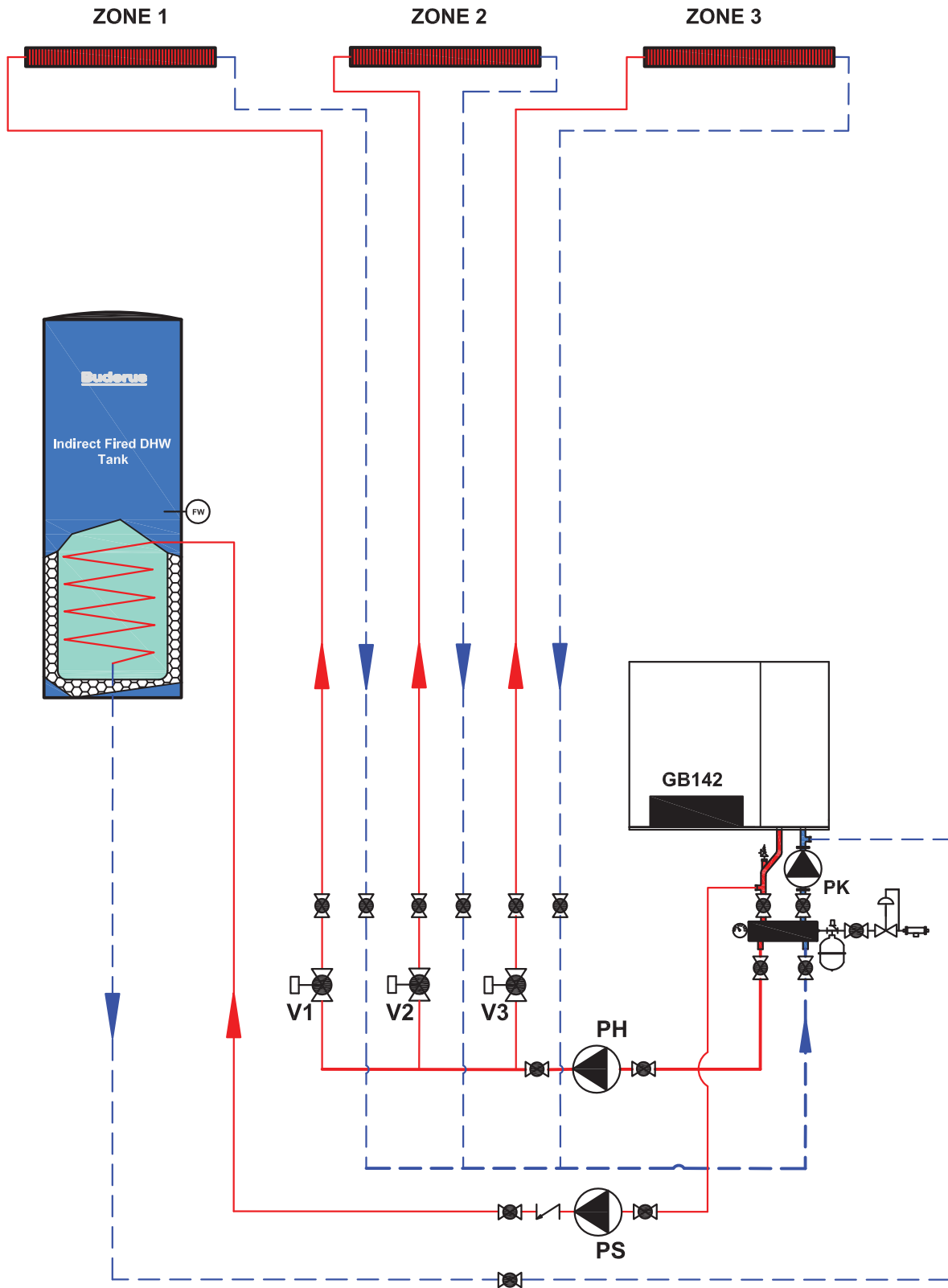

Wiring Diagram - System 2

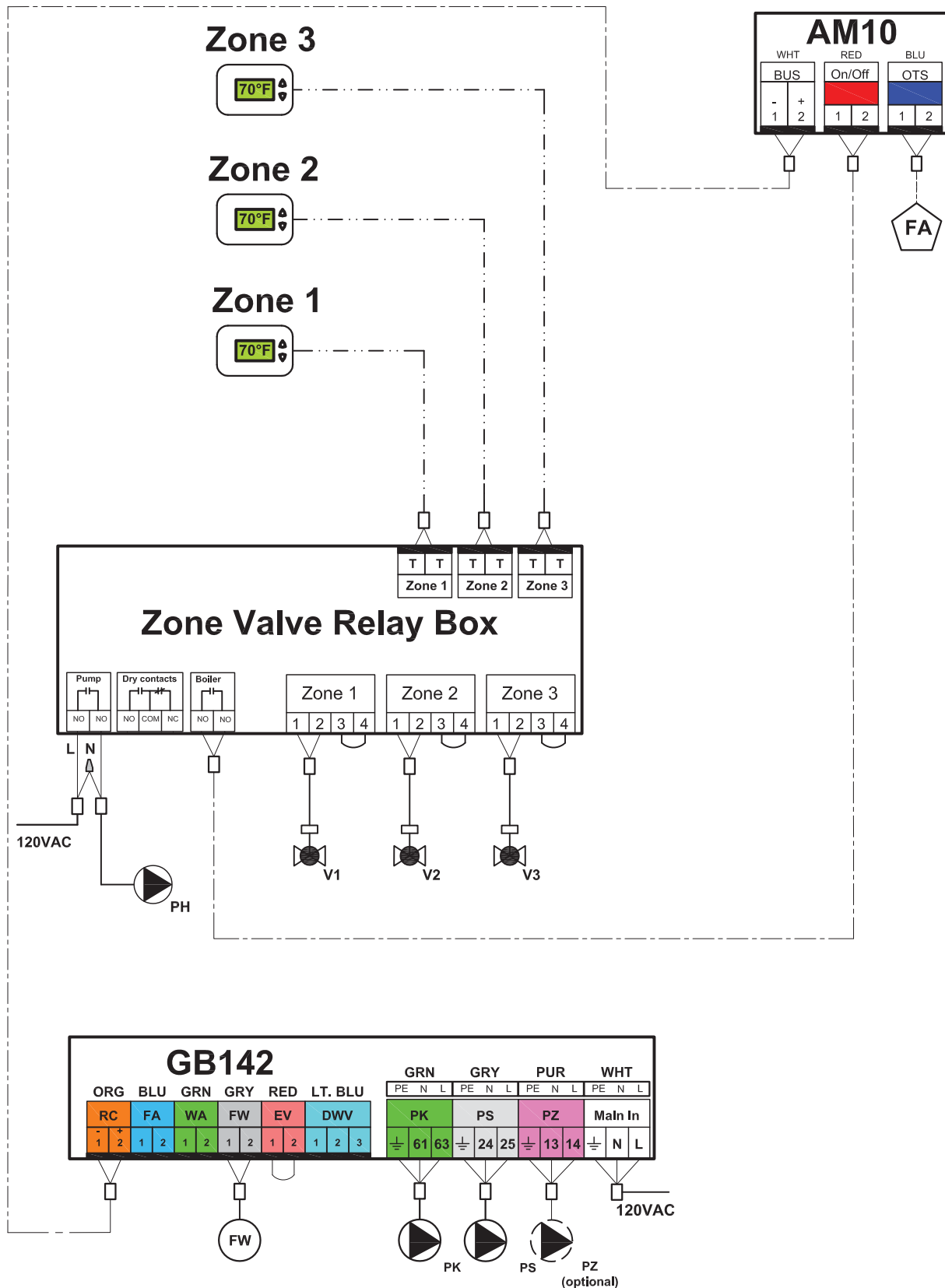

Programming - System 2

- When powering up the AM10 the current outdoor temperature is displayed (Fig. 26).
- Press the mode key to switch to the next menu item. On the screen a block will indicate the current step from 1 through 5.
- The second menu item is the current supply temperature computed based on the current outdoor temperature (Fig. 27).
- Press the mode key to switch to the next menu item.
- Define the heating curve by entering two distinct set points. (A) Supply water temperature at 14°F (-10°C) outdoor temperature (Fig. 28), and by pressing the mode key again, (B) supply water temperature at 68°F (20°C) outdoor temperature (Fig. 29).
- Press the mode key to switch to the warm weather shut down (WWSD) temperature (Fig. 30). If the outdoor temperature rises above this value space heating will stop.
- Pressing the mode key again will return the display to the current outdoor temperature (Fig. 26).

	Range	Factory Default
Supply water temperature at 14°F:	68 - 194 °F	167 °F
Supply water temperature at 68°F:	68 - 194 °F	86 °F
Warm weather shut down temperature:	32 - 86 °F	70 °F

See also chapter 2.3 for additional information on the AM10.

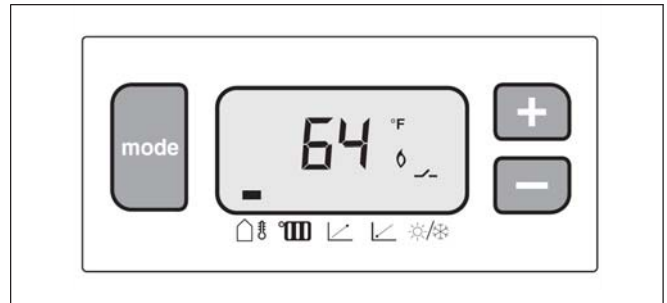

Fig.26 Default display: Current outdoor temperature

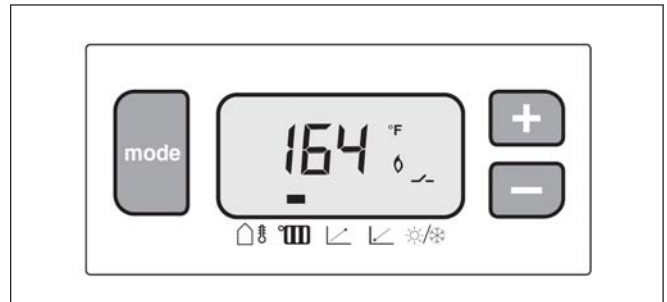

Fig. 27 Current target supply temperature



Fig. 28 Heating curve upper value (14 °F)

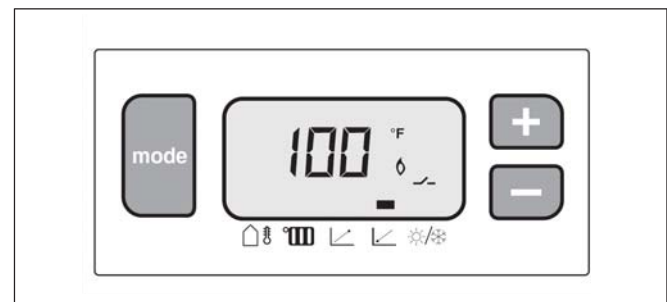

Fig. 29 Heating curve lower value (68 °F)

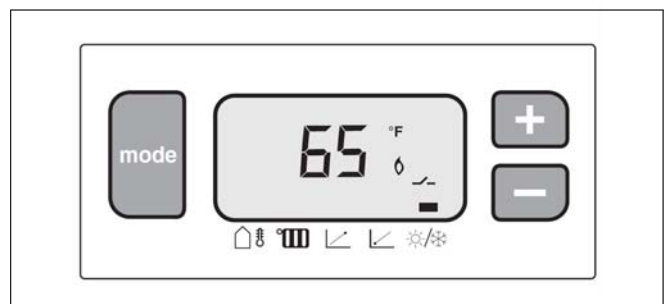

Fig. 30 Warm weather shut down temperature

3.3 System 3: Single boiler with RC35, one heating zone, WM10 and DHW priority

Summary:

Ideal setup for large open floor plans, e.g. restaurants, churches, retail, shop floors, etc.

Single boiler system supplying one zone

- Outdoor reset with room feedback
- RC35 room sensor and user interface installed in a reference room for room feedback
- Zone pump is controlled by the boiler
- Separate day and night temperature program with multiple setpoints for the heating zone and DHW separately
- DHW loading with or without priority
- Maximum efficiency from outdoor reset based on heat loss of the structure and maximum comfort from room feedback
- Upgradable to DHW Solar Thermal (see system 4)

In detail:

The RC35 computes a quantified heat demand for the structure based on information from the outdoor sensor, its internal room sensor, and the heating curve. Applications include a high, medium and low temperature zone (e.g. radiant floor, panel radiators, baseboard or hydro-air).

Day and night temperatures can be set based on the unique requirements of the zone and when occupants will be present and absent.

The WM10 module controls the zone pump in constant circulation which prevents temperature swings and provides maximum comfort. Low energy pump recommended.

The modulating boiler strives to run at low fire for the longest time possible where efficiency is at its highest.

DHW is heated according to a customized timer program. DHW priority over space heating can be enabled or disabled. DHW single charge button is used to reload the tank during night mode.

The RC35 user interface come equipped with integrated room sensor and full text display for easy programming and operation.

Displays outdoor temperature curve for yesterday and today. Holiday function allows reduced temperatures during absence and bringing the space back to temperature in time when returning home.

Solar Thermal DHW functionality integrated in controls for easy retrofit (see system 4)

The low loss header decouples the boiler loop from the system loop.

DHW recirculation pump functionality built in with separate timer program.

Required components:

- GB142 boiler
- RC35 controller
- WM10 LLH module
- PH system circulator
- PS DHW tank loading circulator
- ECM pumps (low energy or constant pressure pumps) are recommended for constant flow rate and additional energy savings.

Additional instructions:

Install the system supply temperature sensor FK after the system pump in order to be able to detect a defective pump. Install the DHW tank temperature sensor FW in the tank per the tank instructions. The RC35 is designed for constant circulation. Do not combine the RC35 with zone valves or a relay panel.

Control modes

The following control modes are available with the RC35:

- **Outdoor reset (factory default):**
The system water temperature is calculated in response to the outdoor temperature. This temperature is then delivered to the zones by a constantly operating heating zone pump. The pump will only shut-down in warm weather shut down, night setback (shut-down mode only) or DHW mode (domestic hot water priority only). Install the RC35 unit in the boiler, or in the room with *maximum room influence* set to 0 (factory setting).
- **Outdoor reset with room influence:**
The RC35 must be installed in a reference room in order to record the room temperature accurately. The higher the room influence parameter set the greater its influence on the heating curve. If *maximum room influence* is set to 0 (factory setting), room feedback is disabled.
- **Room reset:**
With outdoor reset disabled and the RC35 installed in a reference room the system water temperature is influenced only by the conditions in the room. Applications include super insulated structures, or rooms with significant solar gain, auxiliary heat (wood stove), or similar.

Piping Diagram - System 3

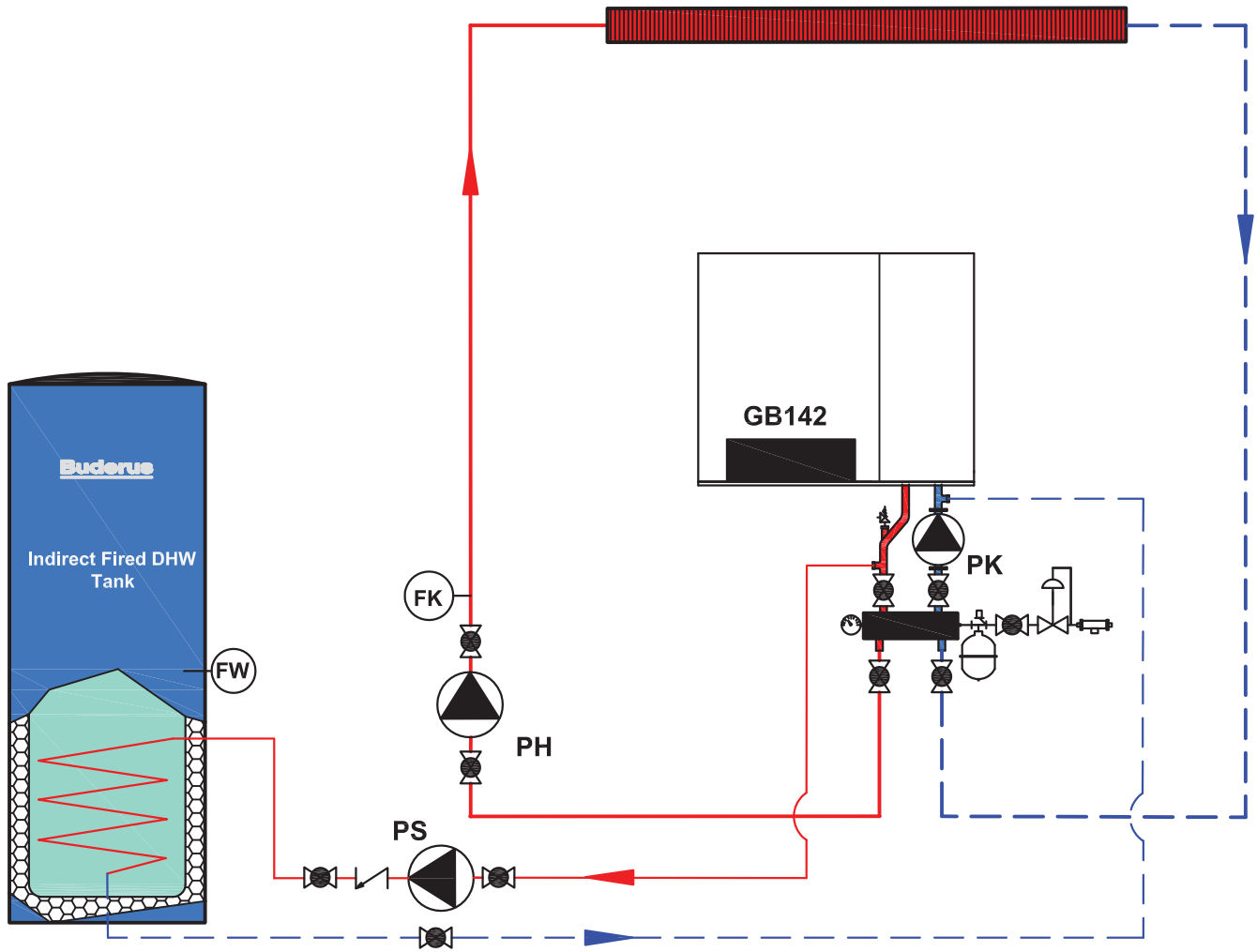

Wiring Diagram - System 3

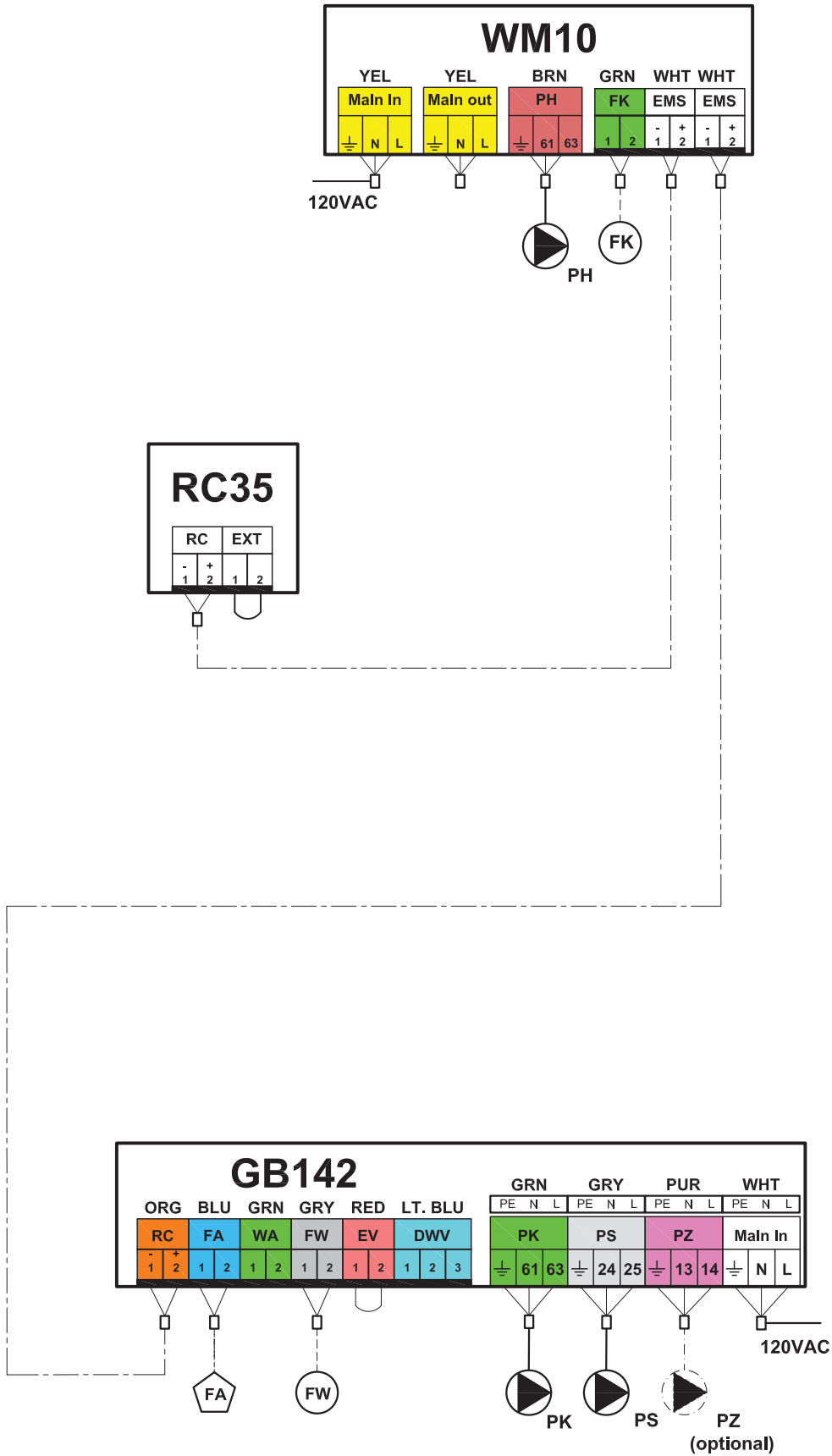

Programming - System 3

Enter the service level in RC35 control as described in the Installation and Service instructions or in chapter 2.4.2.

Important parameters:

- Go to settings, press MENU/OK
- Turn dial clockwise until *Did you install a low loss header module?* appears. Select Yes.
- Turn dial clockwise until *Is heating zone 1 installed (unmixed heating zone)?* appears. Select Yes.
- Press RETURN and select *heating zone 1*, press MENU/OK
- Turn dial clockwise until *Should heating zone 1 be activated?* appears. Select Yes.
- Turn dial clockwise until *Which user interface is assigned to heating zone 1?* appears. Select RC35 if the unit is mounted in a representative room for room reset or outdoor reset with room feedback.

Set up the remainder of the parameters according to the Installation and Service instructions.

See also chapter 2.4 for additional information on the RC35.

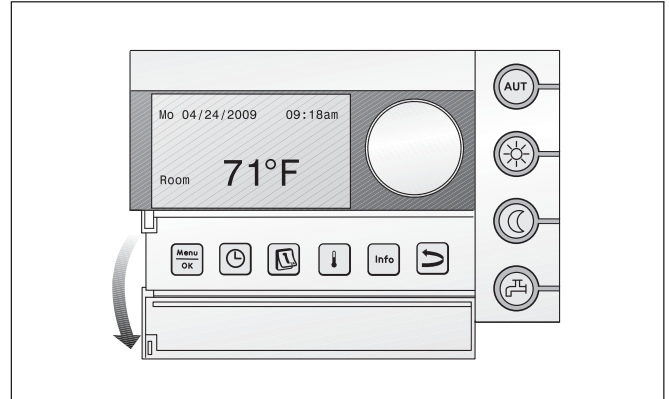

Fig.31 RC35 overview

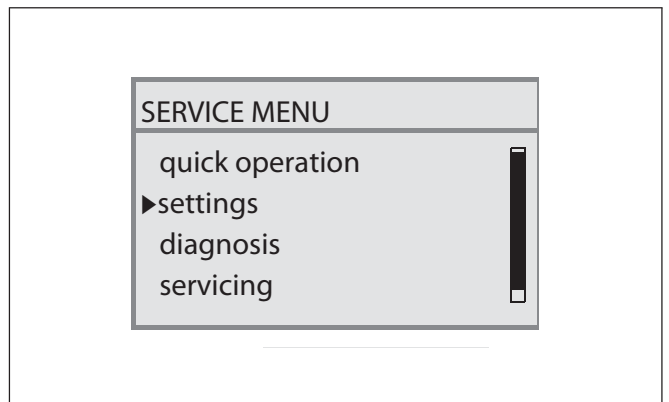

Fig.32 RC35 service menu view

3.4 System 4: Single boiler with RC35, WM10, SM10, one heating zone, & solar thermal DHW

Summary:

Ideal setup for large open floor plans, e.g. restaurants, churches, retail, shop floors, etc. plus a significant DHW demand daily. Single boiler system supplying one unmixed heating zone combined with solar thermal DHW with boiler backup. This is a proven system that is simple to install, almost maintenance free, and fully automated.

- Outdoor reset with room feedback
- RC35 room sensor and user interface installed in a reference room for room feedback
- Zone pump is controlled by the boiler
- Separate day and night temperature program with multiple setpoints for the heating zone and DHW separately
- DHW loading with or without priority
- Maximum efficiency from outdoor reset based on heat loss of the structure and maximum comfort from room feedback
- Solar thermal system loads the DHW tank when solar energy can be harvested
- Integration of solar thermal with the boiler reduces boiler starts and boiler run time and saves fuel

In detail:

The RC35 computes a quantified heat demand for the structure based on information from the outdoor sensor, its internal room sensor, and the heating curve.

Applications include a high, medium and low temperature zone (e.g. radiant floor, panel radiators, baseboard or hydro-air).

Day and night temperatures can be set based on the unique requirements of the zone and when occupants will be present and absent.

The WM10 module controls the zone pump in constant circulation which prevents temperature swings and provides maximum comfort.

The modulating boiler strives to run at low fire for the longest time possible where efficiency is at its highest.

RC35 user interface with integrated room sensor and full text display for easy programming and operation.

Display of outdoor temperature curve for yesterday and today.

Holiday function allows reduced temperatures during absence and bringing the space back to temperature in time when returning home.

Solar thermal DHW functionality integrated in controls delays or prevents reheating of the tank using fossil fuels when solar activity has been detected. The proven algorithm for solar thermal integration in the boiler control system can reduce DHW burner starts for DHW generation by 25% and fossil fuel usage even further compared to a 3rd party solar thermal system. DHW reheating by the boiler is done according to a

customized timer program. DHW priority over space heating can be enabled or disabled. DHW single charge button to reload the tank during night mode.

The RC35 displays solar thermal gain for comparison with previous days.

The low loss header decouples the boiler loop from the system.

DHW recirculation pump functionality is built in with separate timer program.

Required components:

- GB142 boiler
- RC35 controller
- WM10 LLH module
- SM10 Solar module
- PH zone circulator
- PS DHW tank loading circulator.
- Buderus solar thermal system with collectors, mounting rack, line set, and pump station
- Solar DHW tank

Additional instructions:

Install the zone supply temperature sensor FK after the respective pump in order to be able to detect pump failure. ECM pumps (low energy or constant pressure pumps) are recommended for constant flow rate and additional energy savings.

Control modes

The following control modes are available with the RC35:

- **Outdoor reset (factory default):**
The system water temperature is calculated in response to the outdoor temperature. This temperature is then delivered to the zones by a constantly operating heating zone pump. The pump will only shut-down in warm weather shut down, night setback (shut-down mode only) or DHW mode (domestic hot water priority only). Install the RC35 unit in the boiler, or in the room with *maximum room influence* set to 0 (factory setting).
- **Outdoor reset with room influence:**
The RC35 must be installed in a reference room in order to record the room temperature accurately. The higher the room influence parameter set the greater its influence on the heating curve. If *maximum room influence* is set to 0 (factory setting), room feedback is disabled.
- **Room reset:**
With outdoor reset disabled and the RC35 installed in a reference room the system water temperature is influenced only by the conditions in the room. Applications include super insulated structures, or rooms with significant solar gain, auxiliary heat (wood stove), or similar.

Piping Diagram - System 4

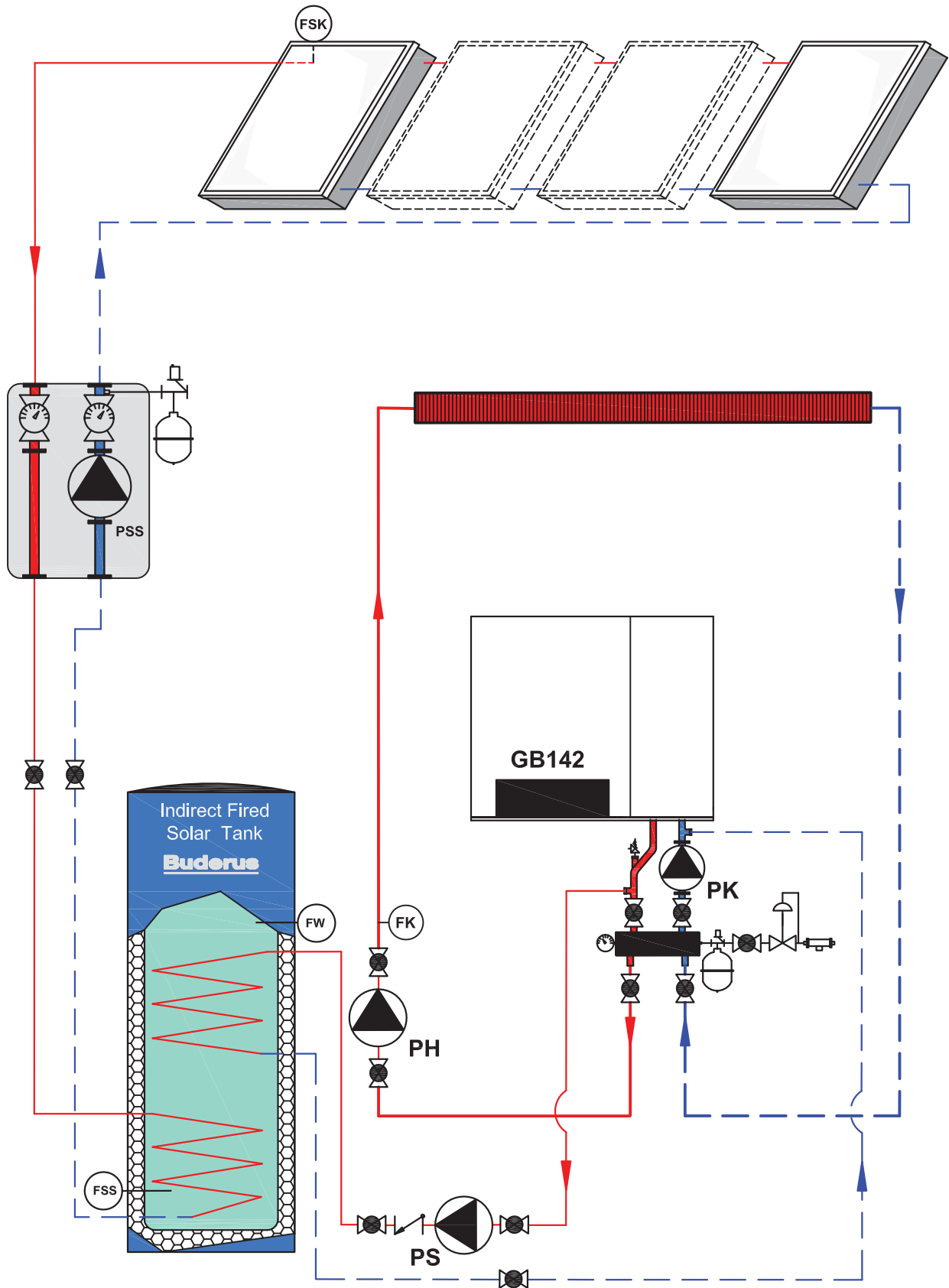

Wiring Diagram - System 4

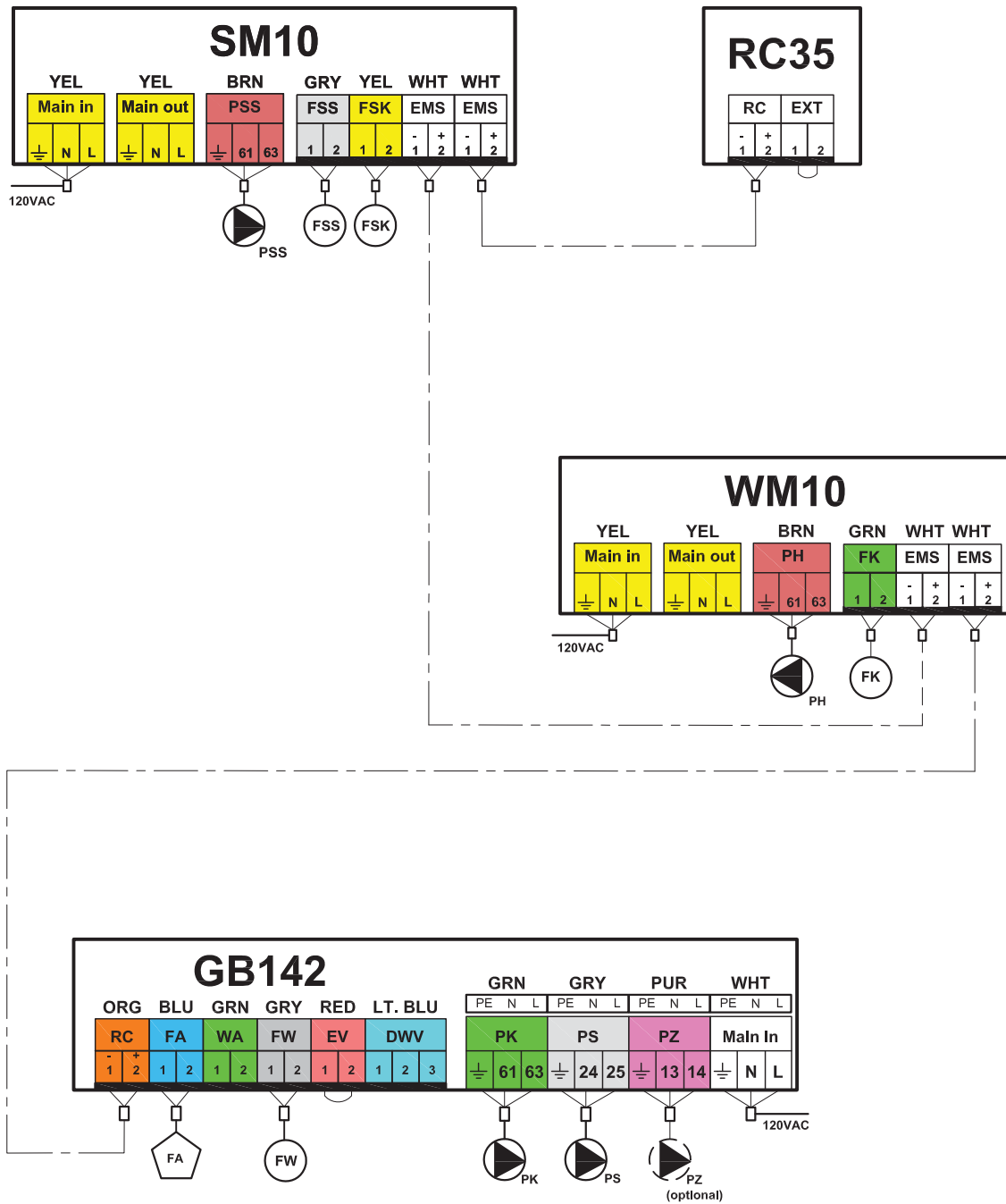

Programming - System 4

Enter the service level in RC35 control as described in the Installation and Service instructions or on chapter 2.4.2.

Important parameters:

- Go to settings, press MENU/OK
- Turn dial clockwise until *Did you install a low loss header module?* appears. Select Yes.
- Turn dial clockwise until *Is heating zone #1 installed (unmixed heating zone)?* appears. Select Yes.
- Press RETURN and select *heating zone #1*, press MENU/OK
- Turn dial clockwise until *Should heating zone #1 be activated?* appears. Select Yes.
- Turn dial clockwise until *Which user interface is assigned to heating zone #1?* appears. Select RC35 if the unit is mounted in a representative room for room reset or outdoor reset with room feedback.
- Turn dial clockwise until *Has a solar module been installed?* appears. Select Yes.

Set up the remainder of the parameters according to the Installation and Service instructions.

See also chapter 2.4 for additional information on the RC35.

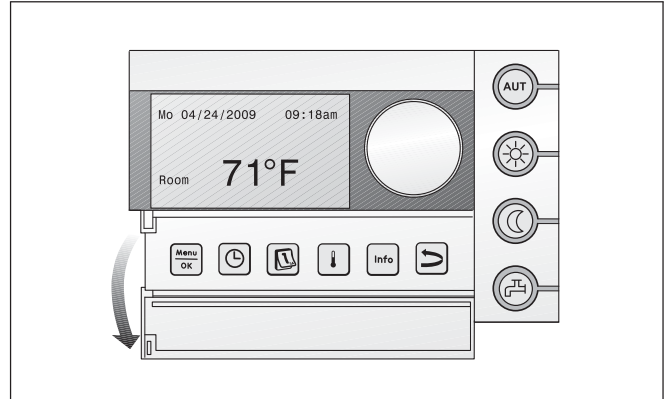

Fig.33 RC35 overview

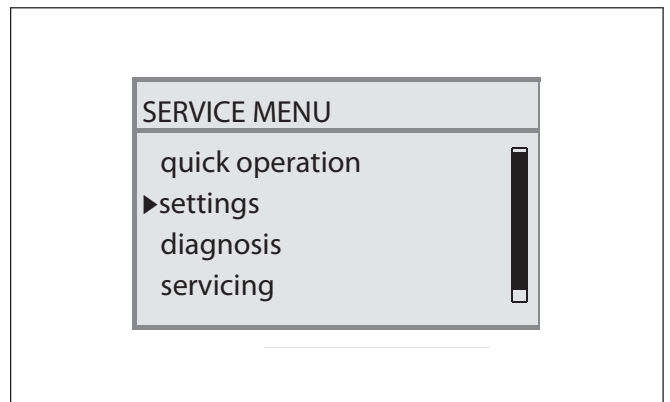

Fig.34 RC35 service menu view

3.5 System 5: Multi-boiler Cascade

Summary:

Multi-boiler system with staging control and many options for heat distribution.

- MCM10 Staging control each for 2 to 4 boilers and a maximum of 16 boilers per system
- Boiler rotation based on hours run time
- Different options for input of heat demand:
 - AM10 outdoor reset controller
 - 0-10V input for output power control (boiler modulation)
 - 0-10V input for supply water temperature control
 - Dry contact input
 - RC35 outdoor reset control with room influence

Boilers are piped in reverse-return for equal flow rate through all boiler headers.

In detail:

The cascade controller fires, runs, and modulates the boilers based on heat demand, plus rotates the boilers to achieve equal run time.

The cascade controller strives to run boilers at low fire for the longest time possible where efficiency is at their highest.

Low loss headers decouple the boilers from the system loop independently of the number of zones calling. Boilers are piped in reverse-return for equal flow rate through all boiler headers.

Required components:

- GB142 boilers with individual manifolds and low loss header
- MCM10 multi cascade module (up to 4 boilers each)
- Heat demand input via:
 - AM10 outdoor reset controller
 - 0-10V input (output power or system supply water temperature)
 - Dry contact input
 - RC35 outdoor reset control with room influence

Piping Diagram - System 5

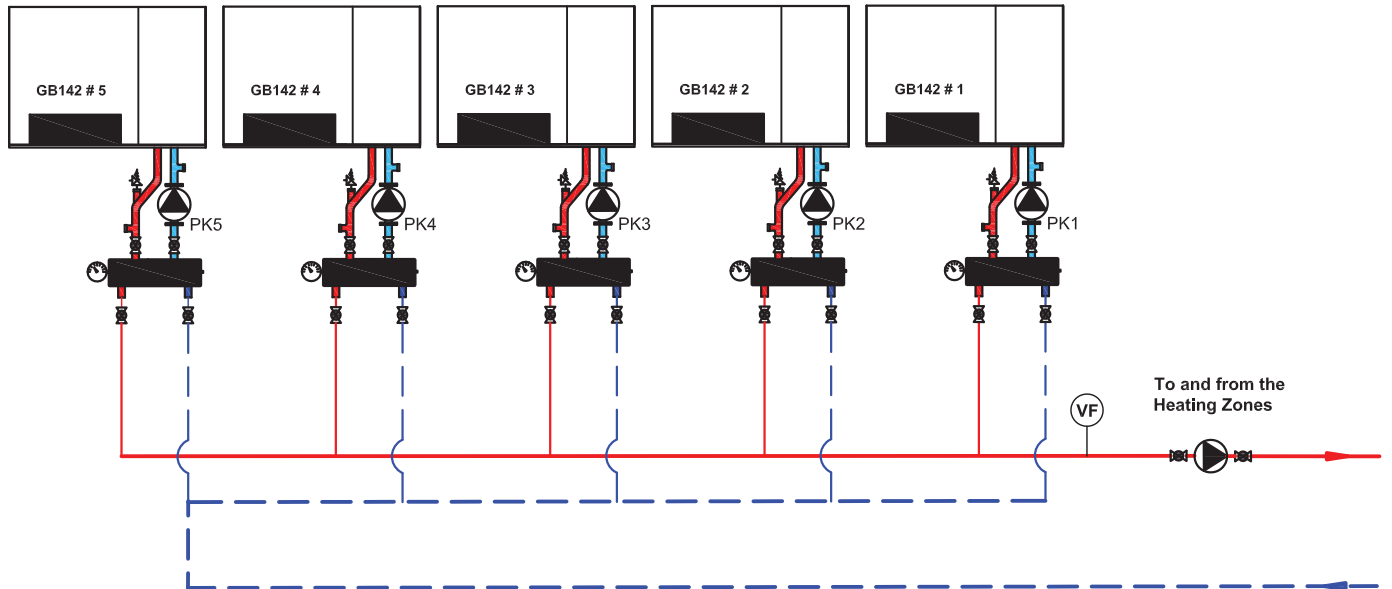

NOTE: Up to 16 boilers can be cascaded using this setup. Only 5 boilers are shown for clarity.

Wiring Diagram - System 5

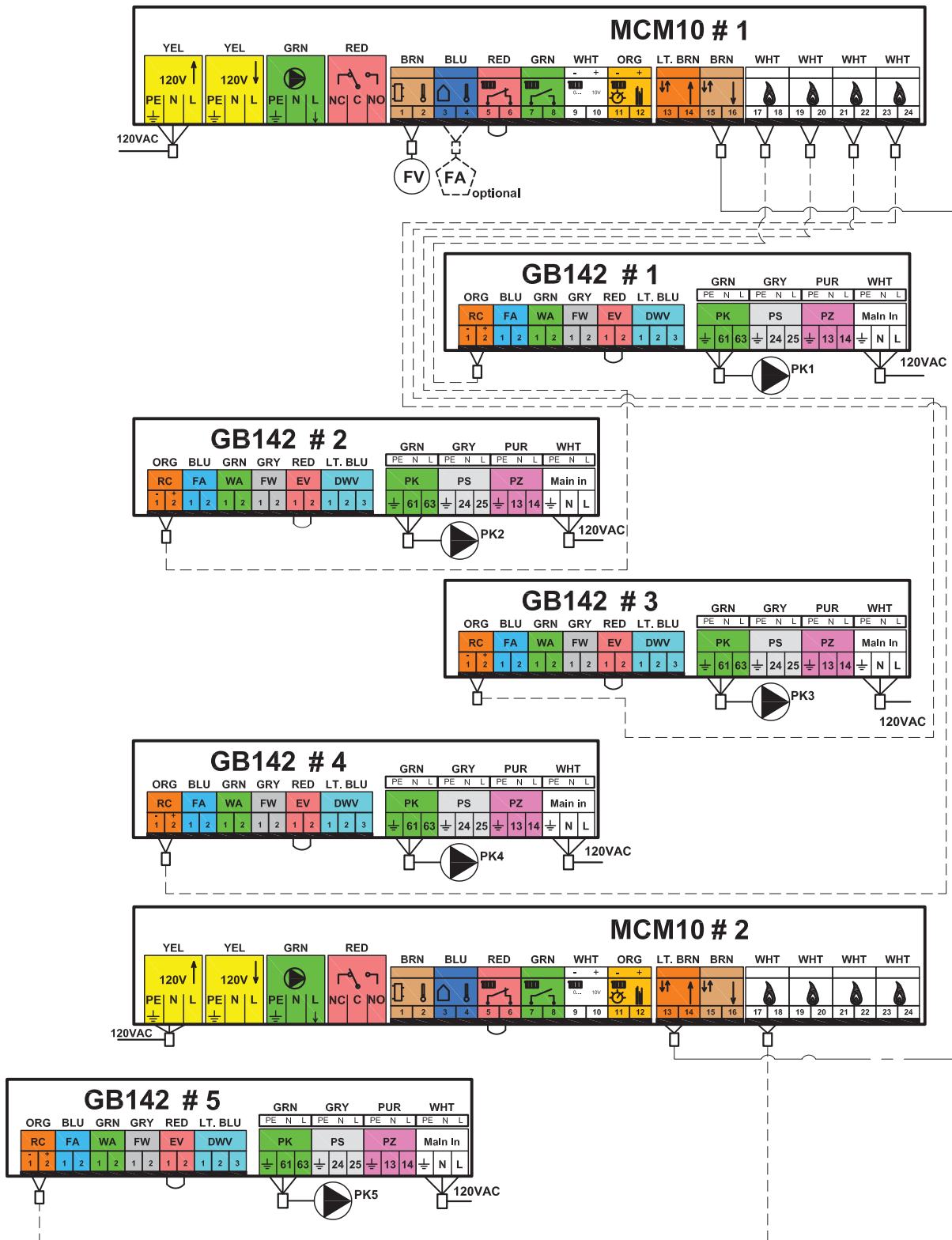

NOTE: Up to 16 boilers can be cascaded using this setup. Only 5 boilers are shown for clarity. When using the RC35 and WM10 versus the AM10, note the different sensor locations for accurate operation.

Programming - System 5

MCM10 multi cascade controller does not require any programming.

- Set boiler dial on BC10 to AUT on each boiler.
- Set DHW dial on boiler to the OFF position if not in use.

Wiring detail

- If using the AM10 follow the wiring and programming in chapter 2.3. Connect a system supply sensor to pins 1/2.
- If using a 0-10V signal from a BMS connect to pins 9/10.
Notice: Polarity sensitive: Ensure connection to the correct poles: 9 = negative, 10 = positive
See Appendix 2 for details on this control option.
- If using a dry contact closure for heat demand use pins 7/8.
- If using the RC35 for outdoor reset control with room influence (see Systems 1 and 2), connect to pins 11/12.
Connect the outdoor sensor to pins 3/4.

For additional information consult the MCM10 installation manual.

Appendix

- **Appendix 1 - Single boiler with 0-10V heat demand input**
- **Appendix 2 - Multi-boiler cascade with 0-10V heat demand input**
- **Appendix 3 - Adding DHW priority to a multi-boiler cascade**

Appendix 1 - Single boiler with 0-10V heat demand input

A single boiler can be controlled via a quantified 0-10V heat demand signal from a building management system. The EM10 module will read the 0-10V signal and modulate the boiler according to:

- (1) the system supply temperature
- (2) power output

Control based on supply temperature

The EM10 uses the 0-10V signal of the building management system to compute the system supply temperature set point. This is a linear ratio (table 5).

Input voltage (V)	Flow temperature set point (boiler)		Status of boiler
	(°F)	(°C)	
0	32	0	OFF
0.5	32	0	OFF
0.6	± 59	± 15	ON/heat demand
5.0	± 122	± 50	ON/heat demand
10.0	± 194	± 90	ON/heat demand

Table 5

Control based on boiler output

The EM10 uses the 0-10V signal of the building management system to compute a performance set point. This is a linear ratio (table 6).

Input voltage (V)	Performance set point (boiler) [%]	Status of boiler
0	0	OFF
0.5	0	OFF
0.6	6	Low load *)
5.0	50	Part-load
10.0	100	Full load

Table 6

*) The low-load performance depends on the device type. E.g. if the low load of the device is 20% and the control signal is 1 Volt (= 10%), the performance value setting is lower than the low load. In this case the boilers may be cycling on and off.

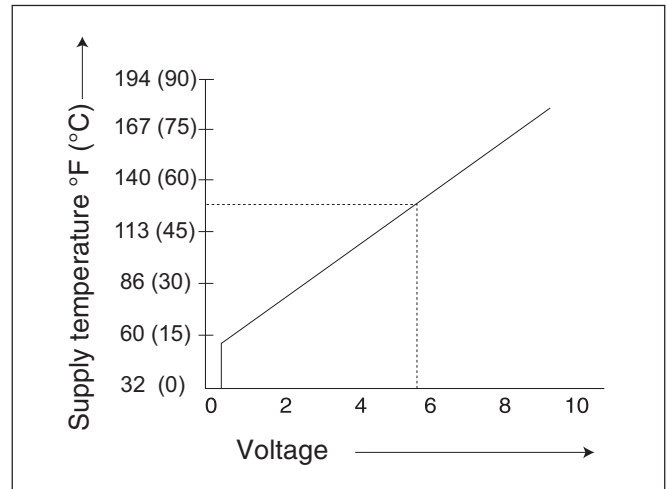

Figure 35 0-10V Diagram

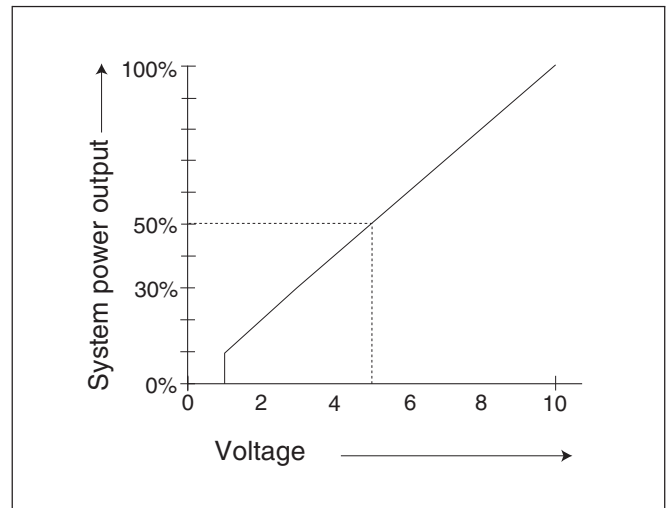
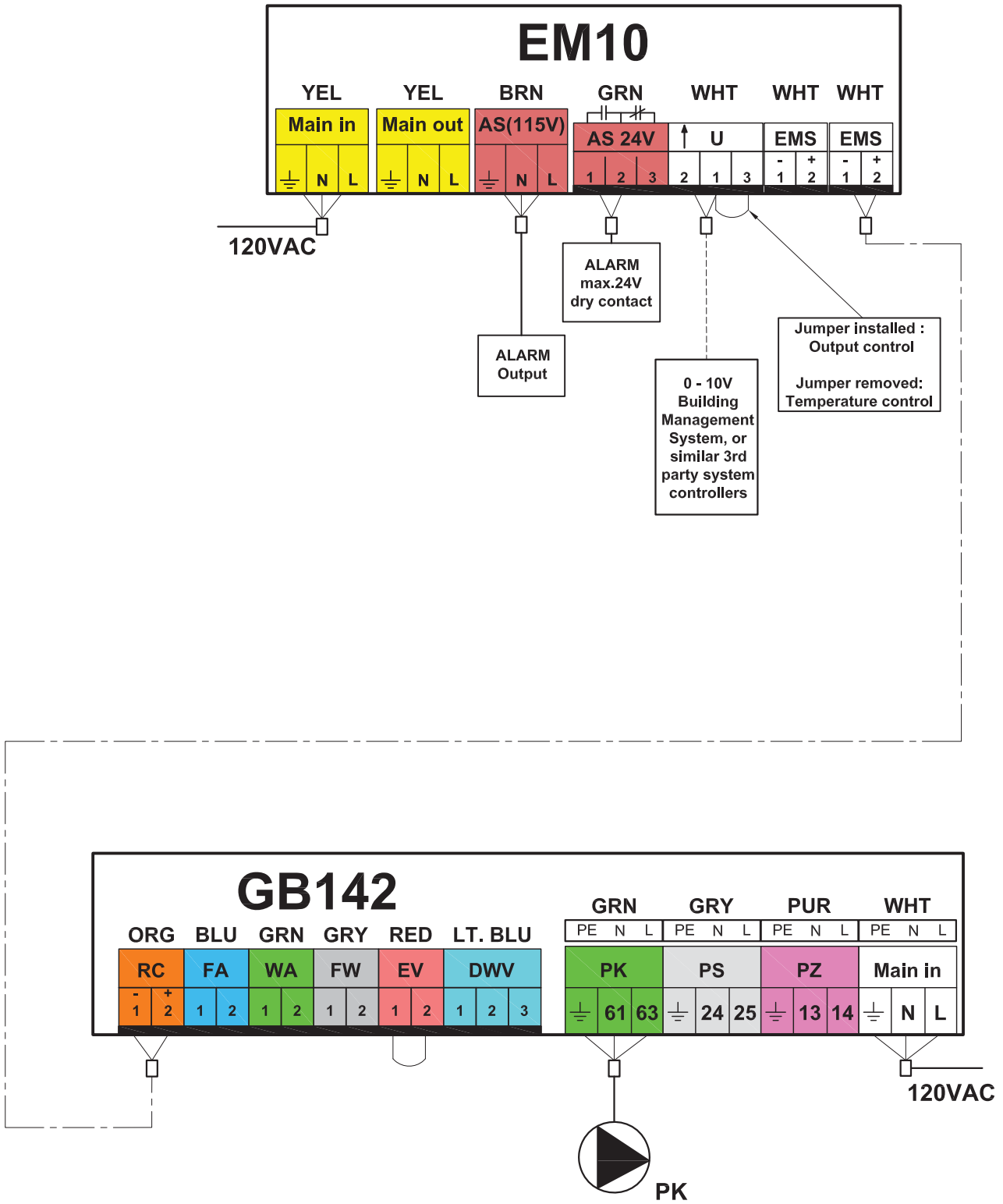

Figure 36 Control based on power output

Appendix 1 - Wiring diagram



Appendix 2 - Multi-boiler cascade with 0-10V heat demand input

The MCM10 accepts a quantified heat demand from a building management system, which can be used to control:

- (1) the system supply water temperature
- (2) power output of the boilers (boiler modulation)

Control of system supply water temperature

The MCM10 uses the 0-10V signal of the building management system to compute the system supply water temperature set point. This is a linear ratio (table 7).

Input voltage (V)	Supply temperature set point (boiler)		Status of boilers
	(°F)	(°C)	
0	32	0	OFF
0.5	32	0	OFF
0.6	59	15	ON/heat demand
5.0	122	50	ON/heat demand
10.0	194	90	ON/heat demand

Table 7

Control of boiler output (boiler modulation)

The MCM10 uses the 0-10V signal of the building management system to compute how many boilers to fire and their modulation. This also depends on supply and return water temperatures, boiler run time, boiler size (if different boiler sizes are used), load, etc. This is a linear ratio (table 8).

Input voltage (V)	Performance set point (boiler) [%]	Status of boiler
0	0	OFF
0.5	0	OFF
0.6	6	Low load *)
5.0	50	Part-load
10.0	100	Full load

Table 8

*) The low-load performance depends on the device type. E.g. if the low load of the device is 20% and the control signal is 1 Volt (= 10%), the performance value setting is lower than the low load. In this case the boilers may be cycling on and off.

Required components:

- GB142 boilers
- MCM10 module

Note: Do not use the AM10 in this configuration

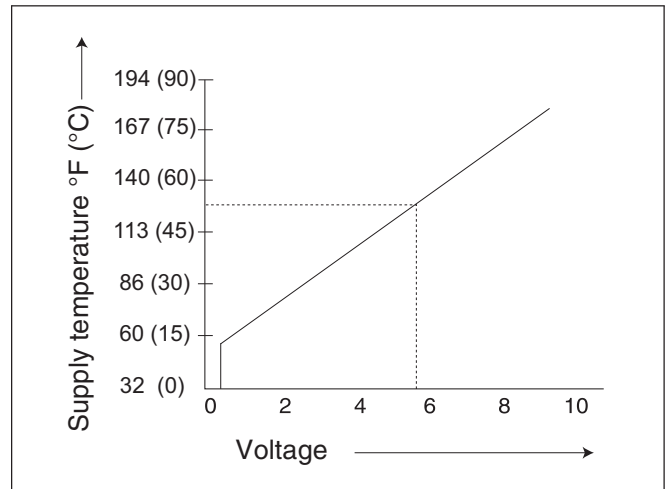

Figure 37 0-10V Diagram

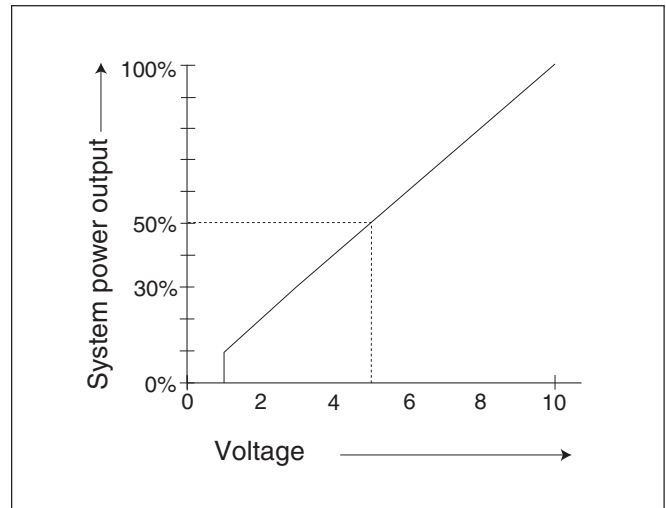
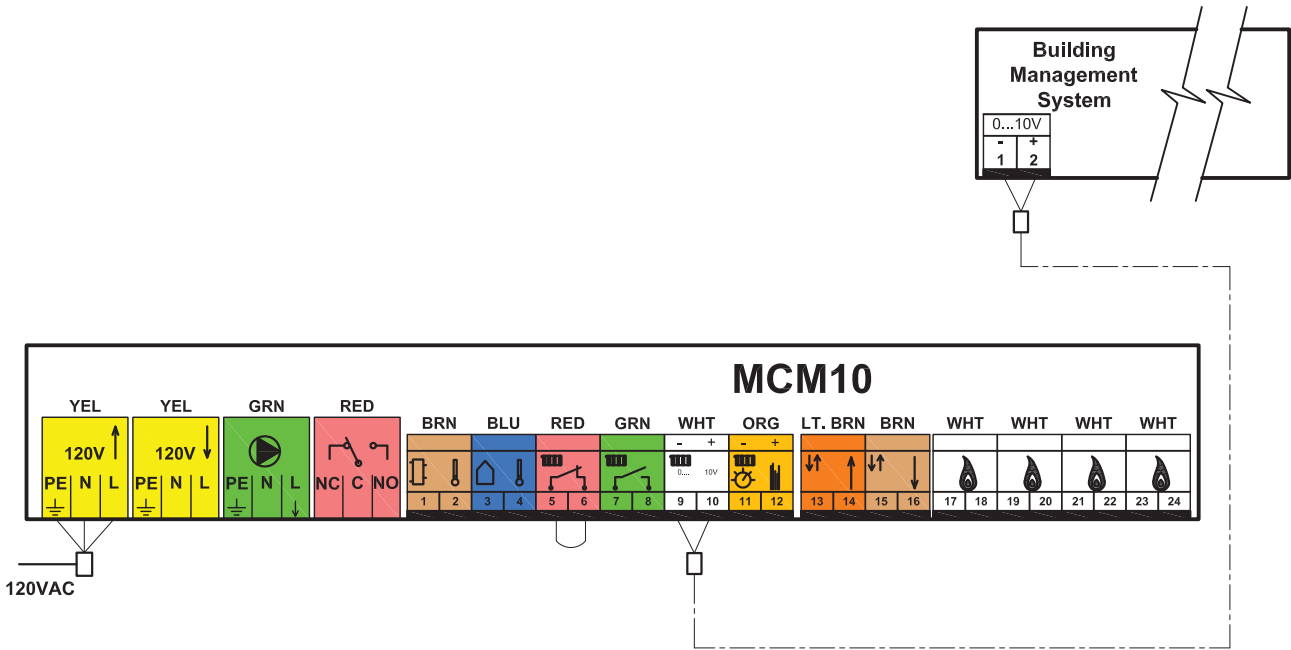

Figure 38 Control based on power output

Appendix 2 - Wiring diagram



MCM10 Manual Jumper

Set Point Acc Supply temperature [°F] Set Point Acc Power Output[%]

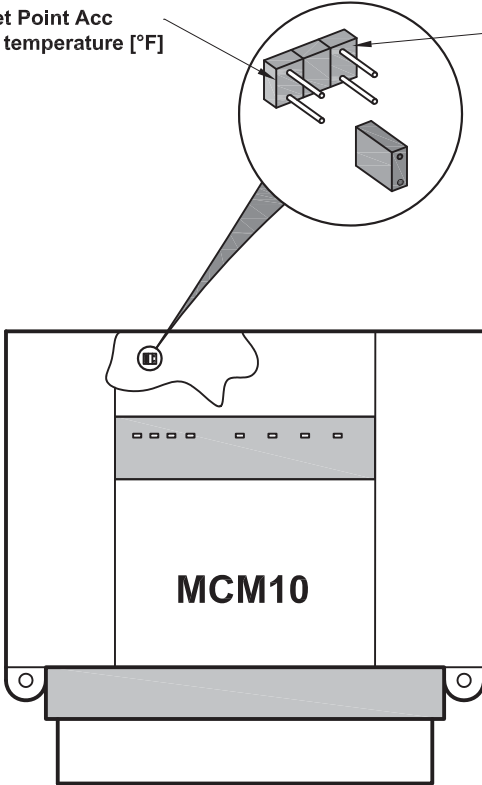

Appendix 3 - Adding DHW priority to a multi-boiler cascade

Description

To add DHW priority to a multi-boiler cascade, use piping and wiring as shown here.

Install a DHW tank aquastat in the indirect fired DHW tank.

Use a zone relay to turn the tank loading pump on and communicate the heat demand to the cascade controller.

Closing contacts 7 and 8 on the MCM10 will fire one boiler after the other until the heat demand is satisfied and the aquastat shuts off, removing the heat demand signal from the MCM10 which shuts down all boilers.

NOTICE: For DHW priority, disable all other consumers during a DHW heat demand by disconnecting their circulators using the N/C contacts on the relay box.

NOTICE: This system may cause the boilers to ramp up to their high limit. To prevent other zones from overheating, take one of the following measures:

1. Disconnect circulators of consumers to be protected from overheating using the N/C contacts on the relay box.
2. Install high limits in the zones to be protected from overheating.
3. Install thermostatic mixing valves in the zones to be protected from overheating.

Appendix 3 - Piping and wiring diagram

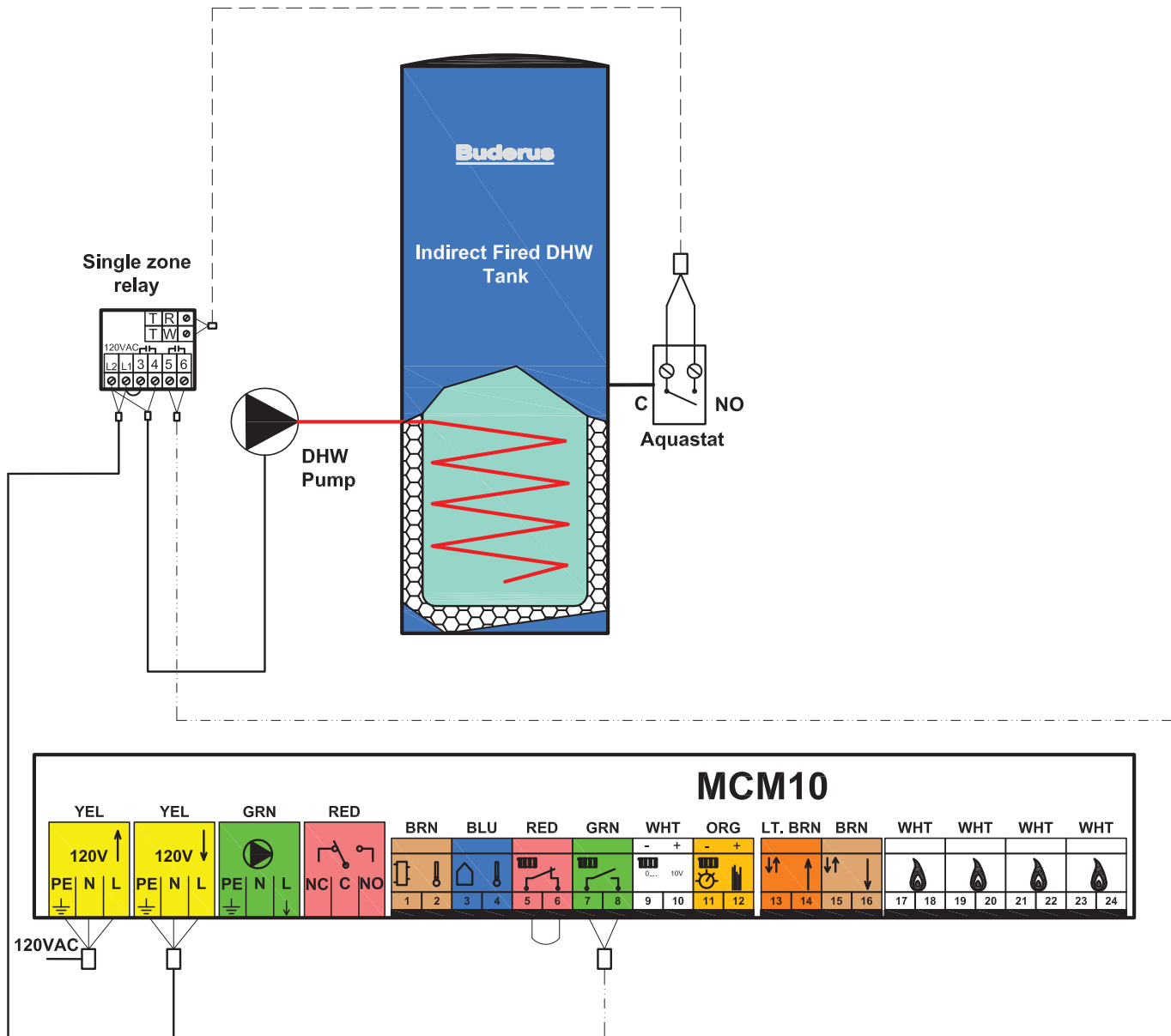

NOTE: Other components not shown for clarity.

Bosch Thermotechnology Corporation
50 Wentworth Avenue
Londonderry, NH 03053
Tel.: 800-283-3787
Fax: 603-965-7581
www.buderus.us

Products manufactured by:
Bosch Thermotechnik GmbH
Sophienstrasse 30-32
D-35576 Wetzlar
www.buderus.de

Bosch Thermotechnology Corporation reserves the right to
make changes without notice due to continuing engineering
and technological advances.
Copyright © 2012 Bosch Thermotechnology Corp. All rights reserved.

BTC 435001101 C

Buderus

Bosch Group