

Aqua-Pure[®]

INSTALLATION AND OPERATING INSTRUCTIONS

AWS SERIES RESIDENTIAL WATER SOFTENERS

MODELS:

AWS100M

AWS150M

AWS200M

AWS300M

**Installer, please leave with homeowner.
Homeowner, retain for future reference.**

INSTR2198 0911

3M



SAFETY INFORMATION

Read, understand, and follow all safety information contained in these instructions prior to installation and use of the Aqua-Pure® AWS Series Residential Water Softener. Retain these instructions for future reference. Failure to follow installation, operation and maintenance instructions may result in property damage and will void warranty.

Intended use:

The Aqua-Pure AWS Series Residential Water Softener is intended for use in softening water in homes and has not been evaluated for other uses. The system must be installed indoors near the point of entry of a home water line, and be installed by qualified professional installers according to these installation instructions.

EXPLANATION OF SIGNAL WORD CONSEQUENCES

 WARNING	Indicates a potentially hazardous situation, which, if not avoided, could result in death or serious injury and/or property damage.
 CAUTION	Indicates a potentially hazardous situation, which, if not avoided, may result in minor or moderate injury and/or property damage.
CAUTION	Indicates a potentially hazardous situation, which, if not avoided, may result in property damage.

WARNING

To reduce the risk associated with choking:

- Do not allow children under 3 years of age to have access to small parts during the installation of this product.

To reduce the risk associated with ingestion of contaminants:

- Do not use with water that is microbiologically unsafe or of unknown quality without adequate disinfection before or after the system.

To reduce the risk of physical injury:

- Shut off inlet water supply and depressurize system as shown in manual prior to service.

To reduce the risk associated with a hazardous voltage:

- If the home electrical system requires use of the cold water system as an electrical safety ground, a jumper must be used to ensure a sufficient ground connection across the filter installation piping — refer installation to qualified personnel.
- Do not use the system if the power cord is damaged — contact qualified service personnel for repair.

To reduce the risk associated with back strain due to the heavy weight of the various system components:

- Follow safe lifting procedures.

CAUTION

To reduce the risk associated skin, eye, and respiratory tract irritation from gravel and filter media during installation:

- Gravel and several types of filter media may be used in this product, depending upon the application. During installation, dust may cause irritation to skin, eyes, and respiratory tract.
- Utilize a NIOSH-approved dust filter mask, protective gloves, and appropriate eye protection when handling and pouring gravel and filter media.
- To request an MSDS relating to this product, call 203-238-8965 or go to www.3M.com, select country, and use the search engine to search MSDS. For emergencies, call 800-364-3577 or 651-737-6501 (24 hours).

CAUTION

To reduce the risk associated with property damage due to water leakage:

- **Read and follow** Use instructions before installation and use of this water treatment system.
- Installation and use **MUST** comply with existing state or local plumbing codes.
- **Protect from freezing**, relieve pressure and drain system when temperatures are expected to drop below 33°F (0.6°C).
- **Do not** install on hot water supply lines. The maximum operating water temperature of this filter system is 110°F (43.3°C).
- **Do not** install systems in areas where ambient temperatures may go above 110° F (43.3° C).
- **Do not** install if water pressure exceeds 125 psi. If your water pressure exceeds 80 psi (552 kPa), you must install a pressure limiting valve. Contact a plumbing professional if you are uncertain how to check your water pressure.
- **Do not** install where water hammer conditions may occur. If water hammer conditions exist you must install a water hammer arrester. Contact a plumbing professional if you are uncertain how to check for this condition.
- Where a backflow prevention device is installed on a water system, a device for controlling pressure due to thermal expansion must be installed.
- **Do not** use a torch or other high temperature sources near filter system, cartridges, plastic fittings or plastic plumbing.
- On plastic fittings, never use pipe sealant or pipe dope. **Use PTFE thread tape only**, pipe dope properties may deteriorate plastic.
- Take care when using pliers or pipe wrenches to tighten plastic fittings, as damage may occur if over tightening occurs.
- **Do not** install in direct sunlight or outdoors.
- Mount system in such a position as to prevent it from being struck by other items used in the area of installation.
- Ensure all tubing and fittings are secure and free of leaks.
- **SHUT OFF FUEL OR ELECTRIC POWER SUPPLY TO WATER HEATER** after water is shut off.
- **Do not** install system where water lines could be subjected to vacuum conditions without appropriate measures for vacuum prevention.
- **Do not** apply heat to any fitting connected to bypass or control valve as damage may result to internal parts or connecting adapters.
- Install on a flat/level surface. It is also advisable to sweep the floor to eliminate objects that could pierce the media tank.

To reduce the risk associated with property damage due to plugged water lines:

- Pay particular attention to correct orientation of control valve. Water flow should match arrow on control valve. The Inlet and Outlet of other water treatment equipment products will vary depending on the control valve brand used.

IMPORTANT NOTES

- Failure to follow instructions will void warranty.

TABLE OF CONTENTS

<u>SECTION</u>	<u>DESCRIPTION</u>
1	BEFORE INSTALLATION
2	INSTALLATION
3	PROGRAMMING
4	SERVICE INSTRUCTIONS & MAINTENANCE
5	PERFORMANCE DATA SHEET
6	TROUBLESHOOTING
7	PARTS
8	LIMITED WARRANTY

SECTION 1: BEFORE INSTALLATION

CAUTION

To reduce the risk associated with property damage due to water leakage:

- **Read and follow** Use instructions before installation and use of this water treatment system.
- Installation and use **MUST** comply with existing state or local plumbing codes.

ELECTRICAL

There are no user-serviceable parts in the AC adapter, motor, or controller. In the event of a failure, these should be replaced.

- 1) All electrical connections must be completed according to local codes.
- 2) Use only the power AC adapter that is supplied.
- 3) The power outlet must be grounded.
- 4) To disconnect power, unplug the AC adapter from its power source.

MECHANICAL

- 1) Do not use petroleum based lubricants such as petroleum jelly, oils, or hydrocarbon based lubricants. Use only 100% silicone lubricants.
- 2) Take care when using pliers or pipe wrenches to tighten plastic fittings, as damage may occur if over tightening occurs.
- 3) All plumbing must be completed according to local codes.
- 4) Soldering near the drain line should be done before connecting the drain line to the valve. Excessive heat will cause interior damage to the valve.
- 5) Observe drain line requirements.
- 6) Do not use lead-based solder for sweat solder connections.
- 7) The drain line must be a minimum of 1/2 inch diameter. Use 3/4 inch pipe if the backwash flow rate is greater than 7 gpm (26.5 lpm) or the pipe length is greater than 20 ft (6 m).
- 8) Do not support the weight of the system on the control valve fittings, plumbing or the bypass.
- 9) It is not recommended to use sealants on the threads. Use thread tape on the threads of the 1 inch NPT elbow, the drain line connections, and other NPT threads.

GENERAL

- 1) Observe all warning and caution statements that appear in this manual.
- 2) Keep the media tank in the upright position. Do not turn upside down or drop. Turning the tank upside down will cause media to enter the valve.
- 3) Operating temperature is between 40°F (4.4°C) and 110°F (43.3°C).
- 4) Rated water pressure range is 20 - 125 psi.

CAUTION

To reduce the risk associated with property damage due to water leakage:

- Installation and use **MUST** comply with existing state or local plumbing codes.
- **Do not** install on hot water supply lines. The maximum operating water temperature of this filter system is 110°F (43.3°C).
- **Do not** install if water pressure exceeds 125 psi. If your water pressure exceeds 80 psi (552 kPa), you must install a pressure limiting valve. Contact a plumbing professional if you are uncertain how to check your water pressure.

- 5) Use only regenerant salts designed for water softening.

IMPORTANT NOTE

SODIUM INFORMATION: Water softeners using sodium chloride for regeneration add sodium to the water. Persons who are on sodium restricted diets should consider the added as part of their overall sodium intake.

- 6) Follow state and local codes for water testing.

WARNING

To reduce the risk associated with ingestion of contaminants:

- **Do not** use with water that is microbiologically unsafe or of unknown quality without adequate disinfection before or after the system.

- 7) When installing the water connections (bypass or manifold) connect to the plumbing system first. Allow heated parts to cool and cemented parts to be set before installing any plastic parts. Do not get primer or solvent on o-rings, nuts or the valve.

IMPORTANT NOTE

If sediment is present, the installation of a sediment pre-filter is recommended. Even if sediment is not currently present or at a level high enough to be objectionable, a pre-filter can help increase the efficiency of the softener and help reduce the amount of maintenance required.

Installation Site Selection:

Select the location of your water softener with care. Various conditions which contribute to proper location are as follows:

- 1) Locate as close as possible to water supply source.
- 2) Locate as close as possible to a drain.
- 3) Locate in correct relationship to other water conditioning equipment (Figure 1, page 2-1).
- 4) Locate the water softener in the supply line BEFORE the water heater. Temperatures above 110°F (43°C) will damage the water softener and void the factory warranty.
- 5) DO NOT install the water softener in a location where freezing temperatures occur. Freezing may cause permanent damage and will also void the factory warranty.
- 6) Allow sufficient space around the installation for easy servicing.
- 7) Provide a non-switched 110V, 60Hz (220V, 50Hz for specified systems) power source for the control valve.

WARNING

To reduce the risk associated with ingestion of contaminants:

- **Do not** use with water that is microbiologically unsafe or of unknown quality without adequate disinfection before or after the system.

CAUTION

To reduce the risk associated with property damage due to water leakage:

- **Protect from freezing**, relieve pressure and drain system when temperatures are expected to drop below 40°F (4°C).
- **Do not** install on hot water supply lines. The maximum operating water temperature of this water softener is 110°F (43°C).
- **Do not** install in direct sunlight or outdoors.

SECTION 2: INSTALLATION

Proper installation sequence of water conditioning equipment is very important. Refer to the following diagram for your particular water supply. Failure to follow installation, operation, and maintenance instructions may result in property damage due to leakage and will void warranty.

TYPICAL WELL INSTALLATION

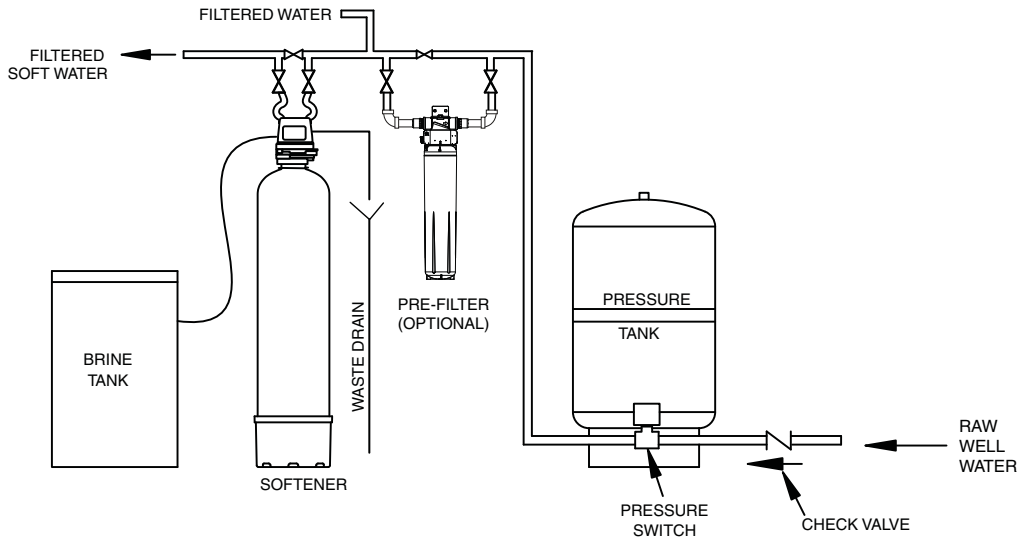

PUBLIC WATER INSTALLATION

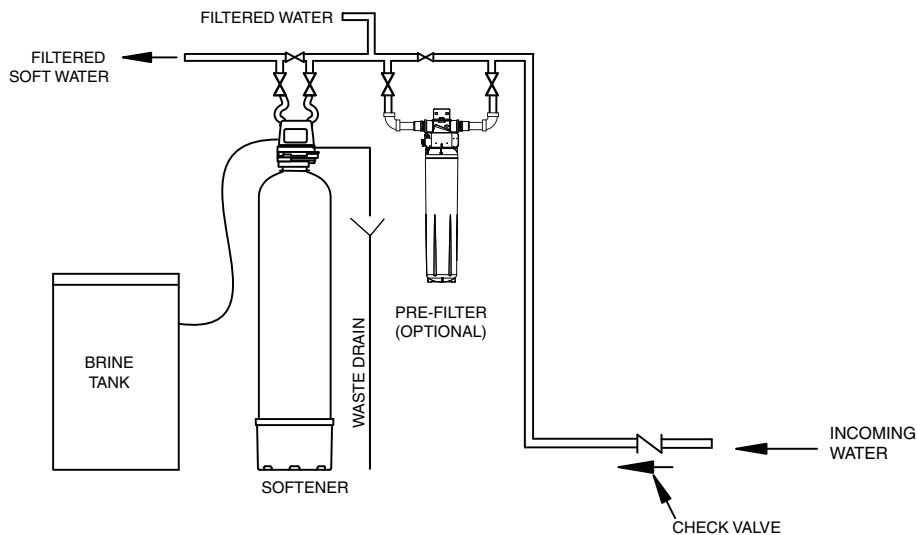

Figure 1

CAUTION

To reduce the risk associated with property damage due to water leakage:

- **Read and follow** Use instructions before installation and use of this water treatment system.
- Installation and use **MUST** comply with existing state or local plumbing codes.

To reduce the risk associated with property damage due to plugged water lines:

- Pay particular attention to correct orientation of control valve. Water flow should match arrow on control valve. The Inlet and Outlet of other water treatment equipment products will vary depending on the control valve brand used.

Step 1) Remove the unit from the shipping box and remove all packaging. Ensure no freight damage has occurred since shipment from our manufacturing facility. Locate the parts package and install the bypass and adapter fittings on the control valve to facilitate the connection to the customer's water supply.

CAUTION

To reduce the risk associated with property damage due to water leakage:

- On plastic fittings, never use pipe sealant or pipe dope. **Use PTFE thread tape only**, pipe dope properties may deteriorate plastic;
- Take care when using pliers or pipe wrenches to tighten plastic fittings, as damage may occur if over tightening occurs.

Step 2) **NOTE: Extension legs should be installed only whenever a salt dosage on any model softener is more than 15 lbs. Models utilizing 15" x 15" x 34" brine tanks require salt grid extension legs when salting the softener above 15 lbs. of salt or more. Models requiring extension leg kits can be ordered through your Dealer/Installer or our Customer Service Department at 1-800-222-7880.**
Verify all packaging materials have been removed from the brine tank. On all units, legs rest on bottom of the brine tank.

Step 3) Shut off all water at main supply valve on a public water supply. On a private well system, turn off power to the pump and drain pressure tank. Make certain pressure is relieved from complete system by opening nearest faucet to drain system.

CAUTION

To reduce the risk associated with property damage due to water leakage:

- **SHUT OFF FUEL OR ELECTRIC POWER SUPPLY TO WATER HEATER** after water is shut off.

Step 4) Cut main supply line as required to fit plumbing to INLET and OUTLET of unit.

Step 5) Attach plumbing. **DO NOT** apply heat to any fitting connected to BYPASS or CONTROL VALVE as damage may result to internal parts or connecting adapters. **MAKE CERTAIN WATER FLOW ENTERS THROUGH INLET AND DISCHARGES THROUGH OUTLET.**

⚠ WARNING

To reduce the risk associated with a hazardous voltage:

- If the home electrical system requires use of the cold water system as an electrical safety ground, a jumper must be used to ensure a sufficient ground connection across the water softener installation piping — refer installation to qualified personnel.

The control valve allows for 1/2" connection for use as a drain line connection.

CAUTION

To reduce the risk associated with property damage due to water leakage:

- On plastic fittings, never use pipe sealant or pipe dope. **Use PTFE thread tape only**, pipe dope properties may deteriorate plastic;
- Take care when using pliers or pipe wrenches to tighten plastic fittings, as damage may occur if over tightening occurs.

Step 6) Attach DRAIN LINE to DRAIN LINE FITTING. To prevent back pressure from reducing flow rate below minimum required for backwash, DRAIN LINE MUST be sized according to run length and relative height. Be careful not to bend flexible drain tubing sharply enough to cause "kinking" (if kinking occurs DRAIN LINE MUST BE REPLACED). Typical examples of proper DRAIN LINE diameters are:

- 1) 1/2" ID up to 15 ft. when discharge is lower than INLET.
- 2) 5/8" ID up to 15 ft. when discharge is slightly higher than the INLET.
- 3) 3/4" ID when drain is 25 ft. away and/or drain is installed overhead.

Some areas prohibit the use of flexible drain lines. Check with local code officials prior to installation.

Step 7) Position DRAIN LINE over drain and secure firmly. To prevent backsiphoning of sewer water, provide an air-gap of at least 2" or 2 pipe diameters between end of drain hose and drain (Figure 2). **DO NOT** raise DRAIN LINE more than 10 ft. above floor.

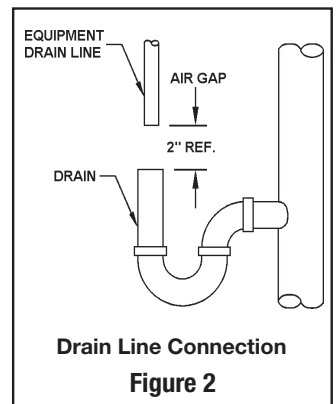

Step 8) Connect one end of the included 3/8" black Polyethylene tubing to the brine fitting located on the left side of the CONTROL VALVE. Connect the other end to the SAFETY BRINE VALVE ELBOW inside of the brine well in the brine tank. To do so remove the retaining clip from the brine line fitting on the control valve. The retaining clip is holding a plastic insert sleeve and needs to be inserted into the polyethylene tubing before installing the tubing into the fitting elbow and hand tighten only. **CAUTION: Do not use pliers or wrenches to tighten as damage may occur and will void the manufacturer's warranty.**

Step 9) Install OVERFLOW LINE to brine tank OVERFLOW FITTING. Discharge of line must be lower than OVERFLOW FITTING. **DO NOT INTERCONNECT OVERFLOW LINE WITH VALVE DRAIN LINE.**

- Step 10) Make certain **BYPASS VALVE INLET and OUTLET KNOBS ARE IN "BYPASS" position**. After all plumbing connections have been completed, open main water shut-off valve and restore power to well pump. Check for leaks and correct as necessary.

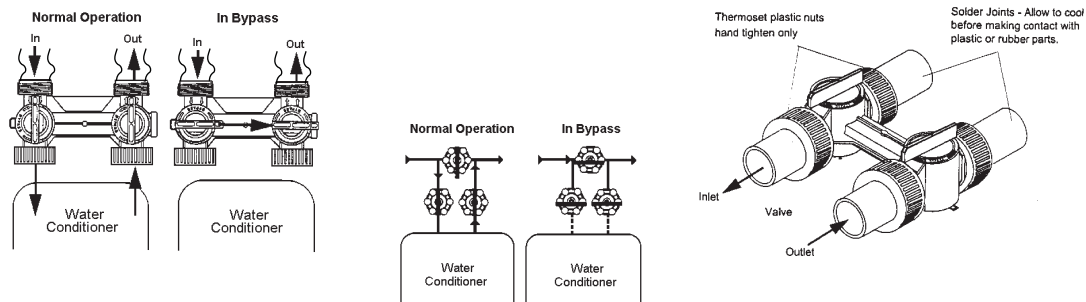

Figure 3

- Step 11) Plug **CONTROL VALVE POWER CORD** into 110v/60Hz, non-switched power source. Program the control valve (refer to page 3-1).

NOTE: Regeneration settings for the control valve are factory preset. The control valve design permits adjustment of the salt setting. This adjustment may be necessary when unusual operating conditions exist, such as high concentrations of iron, manganese or hardness and/or high flow rates or daily water consumption.

- Step 12) Manually stage control to **BACKWASH POSITION**. Press and hold **REGEN** button for 3 seconds. The valve will advance to **BACKWASH POSITION**. Unplug power cord to prevent the unit from advancing automatically.
- Step 13) Partially open **INLET** knob on bypass valve (Figure 3). This will allow the unit to fill slowly from the bottom up, reducing air entrapment. Allow unit to fill slowly, failure to do so could result in loss of resin to the drain. Once a steady stream of water, no air, is flowing to drain the inlet and outlet knobs on the bypass can be fully opened (refer to Figure 3).
- Step 14) Plug the power cord back into the power source. Press the **REGEN** button and wait for the valve to advance to the next regeneration position. Repeat the process until the valve is in Service Position (Time will be on the display).
- Step 15) Refer to **Section 3: Programming**, on how to set control valve for proper set up and regeneration settings.

SPECIAL SERVICE INSTRUCTIONS:

Under normal circumstances removal of valve should not be required. However, if it must be removed, it can be done by rotating the valve head assembly to the left or counter-clockwise. Pressure should be relieved before attempting any disassembly. Upon reassembly, all o-rings should be lubricated with silicone grease. Reattach valve head assembly by rotating to the right or clockwise until valve head assembly is seated to the tank hand tight.

BRINE LINE CONNECTION

The brine line to the brine tank connects to the valve. Make the connections and tighten (See Figure 4). Be sure that the brine line is secure and free from air leak. Even a small leak may cause the brine line to drain out, and the conditioner will not draw brine from the tank. This may also introduce air into the valve causing problems with valve operation.

ELECTRICAL CONNECTION

All AWS controllers operate on 12-volt alternating current power supply. This requires use of the supplied AC adapter.

AC ADAPTERS

Make sure power source matches the rating printed on the AC adapter.

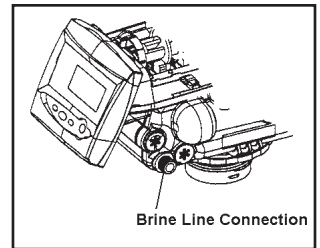

Figure 4

IMPORTANT NOTE

The power source should be constant. Be certain the AC adapter is not on a switched outlet. Power interruptions longer than 8 hours may cause the controller to lose the time and day settings. When power is restored, the day and time settings must then be reentered.

CAMSHAFT

The front end of the camshaft has an indicator cup. The cup has slots in the outer periphery and numbers on the inside face. The numbers can be seen with the cover off, from the front over the top of the controller. The number at the top indicates which regeneration cycle is currently in progress (See Figure 5).

CAMSHAFT FRONT END

The corresponding slot for the number is positioned at the optical sensor which is approximately 90 degrees out of phase.

Regeneration Cycle Indicators

- C0 = Treated Water - normal operation mode
- C1 = Backwash Cycle
- C2 = Brine Draw Cycle
- C3 = Slow Rinse Cycle
- C4 = System Pause
- C5 = Fast Rinse Cycle 1
- C6 = Backwash Cycle 2
- C7 = Fast Rinse Cycle 2
- C8 = Brine Refill

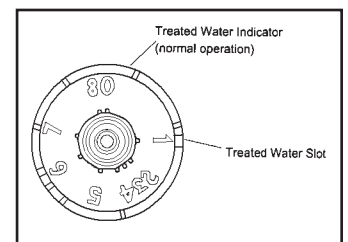

Figure 5

POWER LOSS MEMORY RETENTION

The AWS series controllers feature battery-free time and date retention during the loss of power. This is designed to last a minimum of 8 hours depending on the installation. The controller will continue to keep time and day in dynamic memory while there is no AC power.

The controller will not track water usage on volumetric demand controls in the event of a power failure.

All programmed parameters are stored in the static memory and will not be lost in the event of a power failure. These settings are maintained separately from the time and day settings.

Information entered or calculated by the controller is stored in two different ways:

A static memory will store:

- Media volume
- Regenerant setting
- Time of regeneration
- Days between regeneration

A dynamic memory with 8 hour retention will store:

- Current day of week
- Running clock

MOTOR

The controller uses a standard 12-volt AC motor that works with either 50 Hz or 60 Hz.

IMPORTANT NOTE

Water flow to the valve can be turned on or bypassed when the controller is powered up for the first time.

VARIABLE RESERVE FUNCTION

The AWS metered-demand volumetric controllers are designed to have a variable reserve feature. This feature automatically adjusts the reserve to the end-user's water usage schedule.

A variable reserve saves salt and water by only regenerating when absolutely necessary, and ensures enough soft water for typical high-water usage days.

Each day of regeneration the controller reviews the last four weeks of water usage for the same day of the week to determine if the remaining capacity is adequate for the next day of the week. If not, it will initiate an automatic regeneration.

DISPLAY ICONS

IMPORTANT NOTE

In normal operation and during programming, only a few of the icons will actually be displayed.

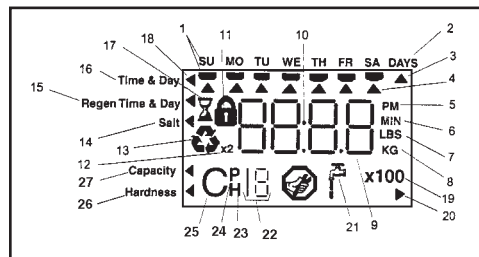

Figure 6

- 1) Days of the week. The flag immediately below the day will appear when that day has been programmed as a day the system should regenerated (used with 7-day timer programming).
- 2) This indicator is displayed when the days between regeneration are being programmed (used with .5 to 99 day regeneration programming).
- 3) This cursor is displayed when the days between regeneration are being programmed (used with .5 to 99 day regeneration programming).
- 4) One of these cursors will be displayed to indicate which day will be programmed into the controller
- 5) "PM" indicates that the time displayed is between 12:00 noon and 12:00 midnight (there is no AM indicator). PM indicator is not used if clock mode is set to 24-hour.
- 6) When "MIN" is displayed, the value entered is in minutes increments.
- 7) When "LBS" is displayed, the value entered is in pounds.
- 8) When "Kg" is displayed, the value entered is in kilograms or kilograins.
- 9) Four digits used to display the time or program value. Also used for error codes.
- 10) Colon flashes as part of the time display. Indicates normal operation.
- 11) Locked/unlocked indicator. In Basic User programming this is displayed when the current parameter is locked-out. It is also used in Professional programming to indicate if the displayed parameter will be locked (icon will flash) when controller is in Basic User.
- 12) When "x2" is displayed, a second regeneration has been called for.
- 13) The recycle sign is displayed (flashing) when a regeneration at the next time of regeneration has been called for. Also displayed (continuous) when in regeneration.
- 14) The display cursor is next to "SALT" when programming the amount of regenerant.
- 15) The display cursor is next to "REGEN TIME & DAY" when programming the time of regeneration and the days of regeneration.
- 16) The display cursor is next to "TIME & DAY" when programming the current time and day.
- 17) The hourglass is displayed when the motor is running. The camshaft should be turning.
- 18) These cursors will appear next to the item that is currently displayed.
- 19) X100 multiplier for large values.
- 20) Not used.

- 21) Shows when water is flowing through the valve.
- 22) Used with #23, #24, #25. Displays a sequence number or a value.
- 23) History Values. The number displayed by #22 identifies which history value is currently displayed.
- 24) Parameter. Displayed only in Professional Programming. The number displayed by #22 identifies which parameter is currently displayed.
- 25) Cycle. The number displayed by #22 is the current cycle in the regeneration sequence.
- 26) Hardness setting.
- 27) Capacity display — shows estimated system capacity.

KEYPAD - BUTTONS

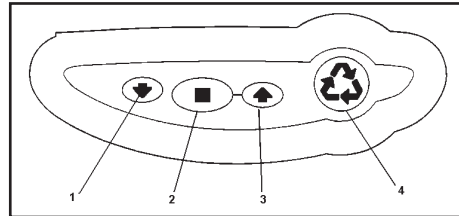

Figure 7

- 1) DOWN arrow. Generally used to scroll down or increment through a group of choices.
- 2) SET. Used to accept a setting that normally becomes stored in memory. Also used together with the arrow buttons.
- 3) UP arrow. Generally used to scroll up or increment through a group of choices.
- 4) Regenerate. Used to command the controller to regenerate. Also used to change the lock mode.

PROGRAMMING CONVENTIONS

The controller is programmed using the buttons on the keypad. The programming instructions will be described two ways whenever a section has keypad input.

First, a table shows simplified instructions. Second, text follows that describes the action. In each table:

“Action” lists the event or action desired.

“Keys” are listed as:

UP for up arrow

DOWN for down arrow

SET for set

REGEN for regeneration

“Duration” describes how long a button is held down:

P/R for press and release

HOLD for press and hold

X sec for a number of seconds to press the button and hold it down

“Display” calls out the display icons that are visible.

REGENERATION MODES

The AWS series controllers can be regenerated either automatically or manually. During a regeneration, the total time remaining of the regeneration, the total time remaining of the regeneration will be displayed on the controller. The current cycle is shown in the lower left of the display.

Regeneration Cycle Indicators

- C0 = Treated Water - normal operation mode (not displayed)
- C1 = Backwash Cycle
- C2 = Brine Draw Cycle
- C3 = Slow Rinse Cycle
- C4 = System Pause
- C5 = Fast Rinse Cycle 1
- C6 = Backwash Cycle 2
- C7 = Fast Rinse Cycle 2
- C8 = Brine Refill

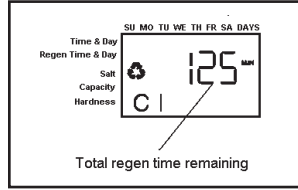

Figure 8

Advancing the Regeneration Cycles

Action	Key	Duration	Display
Show current cycle	SET	HOLD	Cx
Show regen time remaining	SET	HOLD	Time
Advance to next cycle	SET and UP	HOLD	Cx

To advance cycles during a regeneration (manual or automatic):

- Press and hold the SET button. The current cycle number, (Ex. C1) will be displayed along with the time remaining for that individual cycle.
- When holding the SET button, simultaneously press the UP button, and release to advance to the next cycle. While the motor is running, an hourglass icon will be displayed.

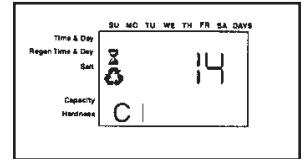

Figure 9

- Repeat this process for each cycle until the system is back into the treated water mode.

IMPORTANT NOTES

- When the controller gets to cycle C4 (Pause cycle), there may be a slight delay before the controller can be advanced onto cycle C5.
- Not all regeneration cycles may be used. A cycle will be skipped if it is not required by the current program.

Cancelling a Regeneration

Action	Key	Duration	Display
Cancel regen	SET and UP	5 sec.	Hourglass starts to flash

To cancel a regeneration (either manual or automatic):

- Press and hold the SET button and UP buttons simultaneously and hold until the hourglass icon starts flashing (approximately 5 seconds).
- The regeneration is cancelled.
- The camshaft rotates to the treated water position (may take up to 2 min.)
- Hourglass flashes while motor runs.

If a second regeneration was programmed (display shows a 2X by the regeneration icon) both regenerations must be cancelled separately.

IMPORTANT NOTES

- Cancelling a regeneration may cause undesirable or salty water to go into the plumbing. Only use this function when absolutely necessary.
- If the regeneration cycle is cancelled after the brine draw cycle (C2), check the water level in the brine tank. It must be refilled to the proper level.

MANUAL REGENERATION

Action	Key	Duration	Display
Regen at next time of regen	REGEN	P/R	Recycle icon flashes
Cancel regen	REGEN	P/R when recycle icon is flashing	Recycle icon disappears
Immediate regen	REGEN	5 sec.	Recycle icon appears
Immediate double regen	REGEN	5 sec. when immediate manual regen has started	X2 icon appears

The controller can be manually instructed to perform a regeneration. There are two (2) choices: The controller will perform a delayed regeneration at the next time of regeneration (ex. 2:00 AM that night), or regenerate immediately.

For a delayed regeneration (at the next set time of regeneration):

- Push the REGEN button once. The recycle symbol will be flashing on the display (Figure 10). Push the REGEN button again to cancel.

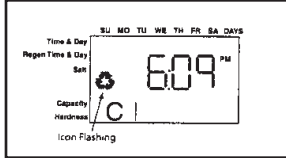

Figure 10

For an immediate regeneration:

- Push and hold the REGEN button for five (5) seconds. The display will show the regeneration symbol. The camshaft will start rotating to cycle C1.

For an immediate, double regeneration:

- After an immediate manual regeneration has begun, and the camshaft has rotated to cycle C1, you can initiate a second immediate manual regeneration.
- Press and hold the REGEN button for 5 seconds once the camshaft has begun cycle C1.
- The display will show a x2 icon indication that a second manual regeneration will occur after the current regeneration is completed (Figure 11).

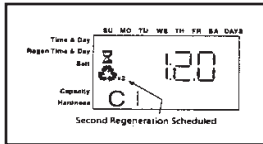

Figure 11

START-UP

IMPORTANT NOTE

The control valve can be started-up even if power is not yet available to the controller. The valve must be connected to water supply. The motor can be unmounted from the valve, and the camshaft can be indexed manually counterclockwise by hand. This will allow the tank to be filled and allows regenerant draw to be tested. See Drive Motor of this manual for further instructions.

- 1) Remove the cover from the valve. Removing the cover will allow you to see that the camshaft is turning, and in which cycle the camshaft is currently positioned.
- 2) With the supply water for the system still turned off, position the bypass valve to the “not in bypass” (normal operation) position.
- 3) Hold the REGEN button on the controller down for 5 seconds. This will initiate a manual regeneration.

The controller will indicate that the motor is turning the camshaft to the cycle C1 (Backwash) position by flashing an hourglass. The controller will display the total regen time remaining (Figure 12).

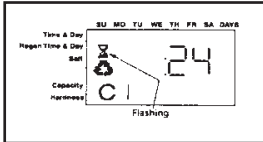

Figure 12

If you press and hold the SET button, the controller will indicate the time remaining in the current cycle.

- 4) Fill the media tank with water.
 - A) While the controller is in cycle C1 (Backwash), open the water supply valve very slowly to approximately the 1/4 open position

IMPORTANT NOTE

If opened too rapidly or too far, media may be lost out of the tank into the valve or the plumbing. In the 1/4 open position, you should hear air slowly escaping from the valve drain line.

- B) When all of the air has been purged from the media tank (water begins to flow steadily from the drain line), open the main supply valve all of the way. This will purge the final air from the tank.
 - C) Allow water to run to drain until the water runs clear from the drain line. This purges any refuse from the media bed.
 - D) Turn off the water supply and let the system stand for about five minutes. This will allow for any air trapped to escape from the tank.
- 5) Add water to the brine tank (initial fill).
 - A) With a bucket or hose, add approximately 2 gallons (8 liters) of water to the regenerant tank.
Add water until the water level is approximately 3 inches (7.6 cm) above the platform.

IMPORTANT NOTE

We recommend that you do not put salt into the tank until after the control valve has been put into operation. With no salt in the tank, it is much easier to view water flow and motion in the tank.

Action	Key	Duration	Display
Display current cycle	SET	5 Sec	Current Cycle
Advance to next cycle	SET and UP	P/R	Next Cycle
Advance to C0	SET and UP	5 Sec	C0

- 6) Engage the refill cycle to prime the line between the brine tank and the valve.
 - A) Slowly open the main water supply valve again, to the fully open position. Be sure not to open too rapidly as that would push the media out of the media tank.
 - B) Advance the controller to the Refill Position. From cycle C1 (Backwash), press and hold the SET button. This will display the current cycle.

While pressing the SET button, press the UP arrow to advance to the next cycle. Continue to advance through each cycle until you have reached cycle C8 (Refill).

IMPORTANT NOTE

As you advance through each cycle there will be a slight delay before you can advance to the next cycle. The hourglass icon will light while the camshaft is indexing. There may be a pause at cycle C4 (System Pause). This cycle allows the water/air pressure to equalize on each side of the valve discs before moving on. The hourglass will not be visible indicating that the system is paused.

- C) With the water supply completely open, when you arrive at cycle C8 (Refill), the controller will direct water down through the line to the brine tank. Let the water flow through the line until all air bubbles have been purged from the line (Figure 13).

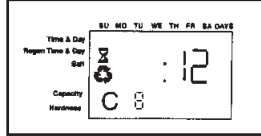

Figure 13

- D) Do not let the water flow down the line to the tank for more than one to two minutes, or the tank may overflow.
- E) Once the air is purged from the line, press the SET button and the UP button simultaneously to advance to cycle C0 (Treated Water) position.
- 7) Draw water from the brine tank.

Action	Key	Duration	Display
Advance to C1	REGEN	5 Sec	REGEN icon steady, C1 and time remaining
Advance to C2	SET and UP	P/R	REGEN icon steady, C2 and time remaining.

- A) From the treated water position (cycle C0), advance the valve to the brine draw position. Hold the REGEN button down for 5 seconds. The controller will begin a manual regen, and advance the control valve to the cycle C1 (Backwash). Press the SET and UP button to advance to cycle C2 (Draw).
- B) With the controller in this position, check to see that the water in the brine tank is being drawn out of the tank. The water level in the tank should recede very slowly.
- C) Observe the water being drawn from the tank for at least three minutes. If the water level does not recede, or goes up, reference the Troubleshooting section.
- 8) If the water level is receding from the tank you can then advance the controller back to the treated water (C0) position by pressing SET and the UP buttons simultaneously to advance the controller to the C0 position.
- 9) Before loading salt add enough water back to the brine tank to cover the salt grid by approximately 3 inches (7.6 cm). Then add initial salt fill to brine tank, and one cup full of unscented laundry bleach to the brine well.
- 10) Put softener through a complete regeneration - to sanitize the system before use (refer to previous section for instructions on manual regeneration).
- 11) After the regeneration is complete, turn on a faucet plumbed after the water softener. Run the faucet until the water runs clear.

Installation is now complete, and your water softener is now ready for service!

SECTION 3: PROGRAMMING

- When the controller is first plugged in, it may display a flashing hourglass and the message Err 3, this means that the controller is rotating to the home position (Figure 14). If the Err 2 is displayed, check that the incoming power frequency matches the controller. See the Troubleshooting section of this manual.
- The preset default time of regeneration is 2:00 AM. If you want to change it, see the instructions in “Basic User Programming”.
- The controller can be programmed to regenerate on specific days of the week. See instructions in “Basic User Programming”.

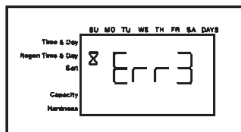

Figure 14

- If electrical power is not available, the camshaft can be rotated to the left by hand if the motor is removed. See Drive Motor on Page 4-2 of this manual for further instructions.
- The controller sends commands to the motor for camshaft movement. However, water pressure/flow are required during the regeneration cycle for backwash, purge and refill, and brine draw to actually take place.
- Make sure control power source is plugged in. The transformer should be connected to a non-switched power source.

The controller is designed to operate by only setting the time of day and the day of the week. The remaining settings have been set at the factory. These default settings will work for most applications.

The controller menu has three levels:

Basic — This level is easily accessed by the user. The settings can be changed and saved as long as they are not locked.

Professional — This level allows the installer to lock settings. The locked settings are viewable in the basic level but cannot be changed.

History — The operation history and the program are viewable. This information is used to troubleshoot and maintain the system.

BASIC USER PROGRAMMING

IMPORTANT NOTES

If a button is not pushed for thirty seconds, the controller returns to normal operation mode. Pushing the regenerate button immediately returns the controller to normal operation.

Any setting that is a time display will not show “AM” for times between 12:00 midnight and 12:00 noon. “PM” is displayed to the right of the time for times between 12:00 noon and 12:00 midnight. When using the 24 hour clock “PM” is not displayed.

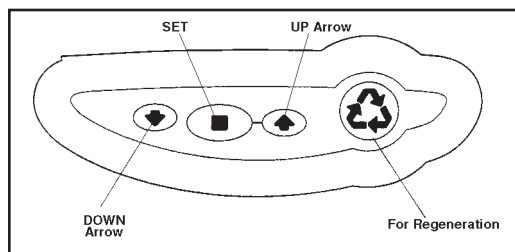

Figure 15

To change a setting:

Action	Key	Duration	Display
Enter basic programming	SET	P/R	Will show day of week
Move to desired display	UP and DOWN arrows	P/R	Will increment through the displays
Enable setting to be changed	SET	P/R	Display will flash
Change setting	UP and DOWN arrows	P/R	Value changes and
Save setting	SET	P/R	Display stops flashing
Return to operation	REGEN	P/R	Normal operation display

This level of programming is accessible by pressing the SET button.

The UP and DOWN arrows will step through the settings.

- Time of day
- Day of week
- Time of regeneration
- Number of days between regeneration (99 day calendar override timer)
- Amount of salt used per regeneration
- System capacity
- Hardness

To make changes:

- Time of day

When the Time of Day is displayed, push SET. The time will flash. Use the arrow buttons to increase/decrease the time. Push SET to enter the selection.

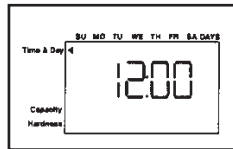

Figure 16

- Days of the week

The day of the week does not have a default setting. It is entered at Power-up. To change the current day, push SET when day of week is displayed. A flag will flash beneath the current day. Use the arrow buttons to change. Push SET to enter the selection.

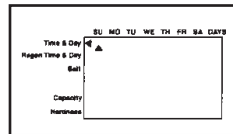

Figure 17

- Time of Regeneration

This is set for 2:00 AM as the default. The controller does not account for daylight savings time.

To change this setting, push SET. Use the arrow buttons to increase/decrease the time. Push SET to enter the selection.

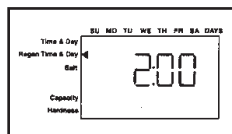

Figure 18

- Calendar override

The controller can be programmed to regenerate automatically from a 1/2 day to a 99 day frequency.

The 1/2 day regeneration mode will regenerate at the “time of regeneration,” as well as 12 hours opposite from that time. For example, the controller will regenerate at 2:00 AM and at 2:00 PM on the same day.

The default setting is 12 days. To change, push SET when this setting is displayed. Use the arrow buttons to increase/decrease. Push SET to enter the selection.

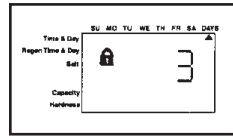

Figure 19

IMPORTANT NOTES

Setting days between regeneration to zero will cause the system to not regenerate. This setting is used for selecting regeneration on specific days or to use with a remote regeneration input. See below.

Regeneration on specific day is used to provide regeneration when water demands are not steady. Example: If the weekdays have low usage and the weekend is high, then regeneration every three days will not meet the requirements.

- Amount of salt used per regeneration

The controllers are setup to automatically calculate the capacity of the system by multiplying the resin/media volume that was entered earlier into the controller, with the salt amount entered by the dealer/installer. This eliminates the need for salting efficiency tables.

The default setting is L (Low Salt).

To enable the most simple programming possible, the dealer/installer has three salt amount options to choose from. These are set up to give the installation the maximum performance based on the inputs by the dealer/installer. The three salt options are:

High Salt — This setting gives the installation the highest capacity possible for that resin volume. This is a great setting for applications with very high hardness, many occupants or for applications where the dealer wants to provide that the application supplies soft water. This setting may tend to use less water over the course of a year, because it generally needs to be regenerated less often. This setting is displayed as an “H”.

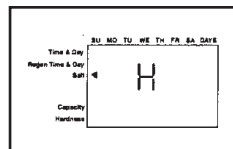

Figure 20

Standard Salt — This setting fits most applications around the world. It gives you an efficient use of salt, while maintaining a large enough capacity to regenerate every three days for most applications. This setting is displayed as an “S”.

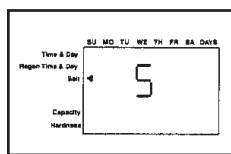

Figure 21

Low Salt — This setting is provided to give your installation the maximum efficiency of salt usage, as measured in grains of hardness softened per pound of salt used (grains of CaCO₃ reduced per pound of salt used). This setting is useful for markets where highly efficient conditioners are expected or required by the consumers or law. This setting is displayed as an “L”.

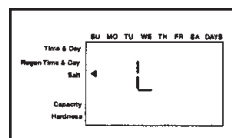

Figure 22

IMPORTANT NOTE

SODIUM INFORMATION: Water softeners using sodium chloride for regeneration add sodium to the water. People who are on sodium restricted diets should consider the added sodium as part of their overall sodium intake.

The following tables show the estimated salt amount for each setting, as well as the estimated capacity of that salt setting for each resin amount.

Media Volume	Salt Setting	Total Salt Amount per Regeneration (lbs)
1.0	L (Low)	3.5
	S (Standard)	9
	H (High)	15
1.5	L (Low)	5.25
	S (Standard)	13.5
	H (High)	22.5
2.0	L (Low)	7
	S (Standard)	18
	H (High)	30
3.0	L (Low)	10.5
	S (Standard)	27
	H (High)	45

L = Low salt, approximately 5 lbs. per cu. ft. of media

S = Standard salt, approximately 9 lbs. per cu. ft. of media

H = High salt, approximately 15 lbs. per cu. ft. of media

To program the salt amount, press the SET button to enter the change mode. The L default will begin to flash. Use the UP and DOWN arrow keys to scroll through the three settings. Press the SET button to enter the amount.

- Capacity

The controller is designed to estimate capacity of the system by multiplying the initial resin/media volume by the regenerant amount programmed in under “Amount of regenerant used per regeneration.”

An estimated total system capacity is displayed in kilograins (kilograms CaCO₃) that could be removed by the fully regenerated media bed. This value is derived by standard water treatment industry norms. The system capacity is displayed merely for the installers reference when determining regeneration frequency.

NOTE: Capacity is the result of the amount of media in the tank and the salt setting. The default capacity will be changed by selecting a different salt setting.

- Hardness setting

The hardness setting is set in grains per gallon (CaCO₃). The hardness is divided into the total capacity setting, giving a total volume of water that can be conditioned before a regeneration is needed. To set, press SET when P8 is displayed, and use the UP or DOWN buttons to increment. Press SET again to accept the setting.

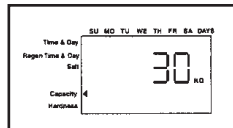

Figure 23

HISTORY

This level displays settings and usage information that can be used to diagnose and troubleshoot the system.

To enter the history level:

Action	Key	Duration	Display
Enter data mode	DOWN arrow and SET	5 sec.	Value for H0
Scroll through history	UP and DOWN arrows P/R	P/R	Next history value
Reset value to factory default	SET	5 secs. with value is displayed	Original factory default

History Data

	Description	Range
H0	Resin volume initial setting value	cubic feet
H1	Days since last regeneration	0-255
H2	Current flow rate	0-47 gpm
H3	Water used today in gallons since Time of Regeneration	0-65536 gallons
H4	Water used since last regeneration in gallons	0-65536 gallons
H5	Total water used since reset in 100s	0-65536 gallons
H6	Total water used since reset in 1,000,000	0-65536 gallons
H7	Average usage for Sunday in gallons	0-65536 gallons
H8	Average usage for Monday in gallons	0-65536 gallons
H9	Average usage for Tuesday in gallons	0-65536 gallons
H10	Average usage for Wednesday in gallons	0-65536 gallons
H11	Average usage for Thursday in gallons	0-65536 gallons
H12	Average usage for Friday in gallons	0-65536 gallons
H13	Average usage for Saturday in gallons	0-65536 gallons

When in history values mode a small “H” will be displayed in the lower left corner of the display. Next to the “H” will be the number that applies to the history value.

H0 — System Resin Volume Setting

The history value H0 displays the initial resin volume setting (programmed when the system was first set up). If the value is incorrect and needs to be reset, press and hold the SET button for five seconds to reset the controller.

IMPORTANT NOTE

Resetting the resin volume resets the entire controller back to the factory default. Only use if absolutely necessary. The control will need to be completely re-programmed.

SECTION 4: SERVICE INSTRUCTIONS & MAINTENANCE

VALVE SERVICE

COVER

The cover provides protection for the controller, wiring, and other components. This cover will be removed for most service and maintenance.

To remove cover:

- 1) Grasp side edges toward rear of the valve.
- 2) Pull outwards until the slots in the cover clears the projections on the top plate.
- 3) Lift up on the rear and pull forward to clear the control module.

To install cover:

- 1) Position cover to be low in front and under the bottom edge of the control module.
- 2) The cover will hook on the bottom of the controller and drop down over the camshaft.
- 3) To finish, grasp the side edges and pull outward to clear the projections on the top plate.
- 4) Drop down until the cover snaps in place.

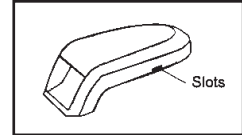

Figure 24

ELECTRONIC CONTROL MODULE

The purpose of the electronic control module is to control the regeneration cycle. The control module has several variations. When replacing the controller, use the same model or some functions may not work. This is an electronic controller that is programmable and uses input/output signals.

To remove control module:

- 1) Disconnect power to the unit.
- 2) Remove valve cover.
- 3) Press trip lever to release module from top plate.
- 4) Pivot the top forward and up.
- 5) Remove any wire connections. Wire connections have a locking tab that must be squeezed before removing.

NOTE: There is no need to label the wires. The keyed connectors will only plug back into one site.

To install control module:

- 1) Be sure the power is disconnected.
- 2) Check model.
- 3) Check routing of wires and plug them into the controller. Connectors will snap in place. Be sure that wires are properly managed through the clips on top plate. This will prevent the wires from being caught in the camshaft.
- 4) Place bottom of module in position. The bottom will fit into a clip.
- 5) Pivot the top into position and snap in place. The controller should be secure.

If you are ready to program the controller, then power can be applied by plugging in transformer.

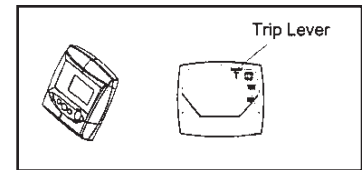

Figure 25

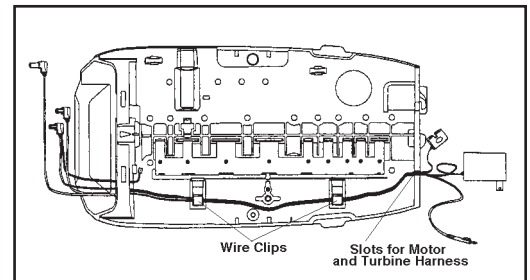

Figure 26

DRIVE MOTOR

The drive motor is open loop and receives commands from the control module. The motor has a pinion gear that meshes with the camshaft gear to drive (rotate) the camshaft.

During operation, rotation forces the motor into its mounting position and screws or bolts are not needed.

NOTE: Some units will have a shipping peg in the top motor mount. The peg can be removed and discarded. This peg is not required for motor operation.

To remove motor:

- 1) Disconnect power to the unit.
- 2) Remove cover.
- 3) Pull off wiring connector.
- 4) Grasp the motor body and rotate to the left.
- 5) Pull motor out.

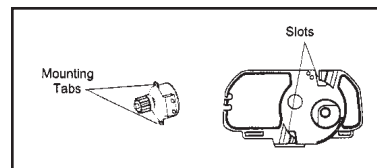

Figure 27

To install motor:

- 1) Insert gear through hole on top plate
- 2) With motor ears flat to the rear of the top plate, rotate to the right until mounting tabs are engaged in slots.
- 3) Reconnect wires.

NOTE: It is not necessary to pre-position the camshaft or the motor. When the controller is powered up the camshaft will be rotated to the “home” position.

OPTICAL SENSOR

The optical sensor is mounted to the top plate. The camshaft cup rotates through the sensor and the slots are detected. A signal is sent to the controller for each slot.

IMPORTANT NOTE

Damaged sensors should be replaced. Sensors may be cleaned with compressed air or a soft brush.

To remove optical sensor:

- 1) Disconnect power to the unit.
- 2) Remove cover.
- 3) Remove controller.
- 4) From the controller side, pinch the legs of the sensor holder in the top plate.
- 5) Pull the holder away from the mounting surface.
- 6) Remove wires.

To install optical sensor:

- 1) Attach wires. Wires should point away from camshaft.
- 2) Place leading edge of sensor holder into opening.
- 3) Pivot holder into place. Legs should enter slots and snap in place.

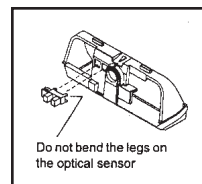

Figure 28

IMPORTANT NOTE

The optical sensor legs are fragile and may break. If the optical sensor legs break or crack, we recommend replacement. A damaged sensor may result in improper regeneration.

CAMSHAFT

The camshaft has several lobes that push open the valve discs as the camshaft rotates. Rotation is controlled by a drive motor that drives a gear at the rear of the camshaft. The front end has a cup with markings and slots.

IMPORTANT NOTE

The camshaft slots are molded to exact dimensions. Do not attempt to modify the cam cup slots. Improper regen will occur!

The outside surface of the cup has an arrow mark. When the arrow is at top center, the camshaft is in the loading position. 90 degrees to the right on the cup an optical sensor is mounted to the top plate. This sensor reads the slots as they pass through. The largest slot is "Home" and the remaining slots are positioned to signal the regeneration cycles.

When looking at the end of the camshaft, numbers are visible in the hollow of the cup. An arrow on the top plate points to the current marking. The numbers represent regeneration cycles as follows:

C0 = Treated water - normal operation mode

C1 = Backwash

C2 = Brine draw

C3 = Slow Rinse

C4 = System pause

C5 = Fast rinse cycle 1

C6 = Backwash cycle 2

C7 = Fast rinse cycle 2

C8 = Brine refill

These numbers are offset rotationally 90 degrees from the matching slot. The offset enable the service person to view the number at the top of the cup and determine which slot is at the optical sensor.

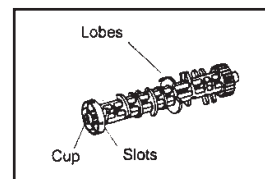

Figure 29

IMPORTANT NOTE

If any part of the camshaft is broken or damaged the camshaft should be replaced. Do not repair or modify damaged cam lobes, gears or timing cup.

To remove camshaft:

- 1) Disconnect power to the unit.
- 2) Remove cover.
- 3) Remove motor.
- 4) Camshaft should be in the treated water position. Rotate to the left as needed.
- 5) Use a screwdriver to hold open the #1 valve disc.

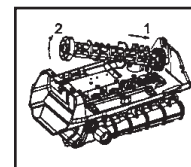

Figure 30

IMPORTANT NOTE

When replacing/removing camshaft, make sure not to damage or misalign the optical sensor. Hold the sensor in position while removing camshaft.

6) Move the camshaft backwards, away from the controller.

7) Lift the loose front end up and out.

To install camshaft:

- 1) Check that the optical sensor is in position.
- 2) Position camshaft above the valve discs. The arrow on the cup should be up.
- 3) Slide the rear of the camshaft into place.
- 4) Pivot the camshaft close to its final position. The camshaft will push on one or more valve discs. You will feel resistance as you complete the installation.
- 5) Move the camshaft down and into position. Force valve discs to move as needed.
- 6) Move the camshaft forward. Check that the optical sensor is in position.
- 7) Install motor.

NOTE: The camshaft will position itself to C0 (treated water) when the controller is powered up.

WIRING HARNESSES

The wiring harnesses are designed to fit one way. The connectors are unique to the port they plug into. The wires are held in place by clips and the connectors latch in place.

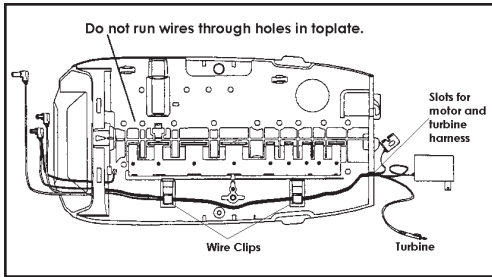

Figure 31

To remove a wiring harnesses:

- 1) Disconnect power to the unit.
- 2) Remove cover.
- 3) Remove controller.
- 4) Remove connections by squeezing the latch on the connector and pulling out.

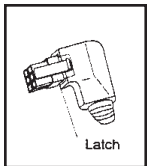

Figure 32

- 5) Pull the harness out of the clips on the top plate.

To install a wiring harness:

IMPORTANT NOTE

Start at the back of the valve and work toward the controller. This will place any slack behind the controller. Slack or loose wires can become tangled in the camshaft.

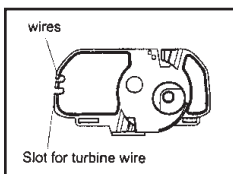

Figure 33

- 1) Depending on which harness is being installed, plug the connector into the motor or turbine.
- 2) Route the harness through the opening at the back of the top plate.
- 3) Place the harness into the clips on the top plate. Do not leave any slack. Put the motor wire in first, then the turbine sensor cable second.
- 4) Feed the wire through the opening on the front of the top plate.
- 5) If installing the motor harness the connector to the optical sensor can be clipped in place.
- 6) Connect the harness to the back of the controller.

NOTE: If using both a motor and turbine cable harness, install the smaller motor cable first. Install the larger turbine cable second. This will lock the motor cable beneath in the wire management clips.

SPRING (VALVE DISCS)

This spring is a one-piece metal spring that applies pressure to the valve discs holding them closed. The rotating camshaft overcomes this pressure to open the valve discs as needed. The shape of the spring is critical for proper operation.

IMPORTANT NOTE

Do not attempt to straighten or repair this spring. If this spring is damaged, valve discs may not operate correctly.

To remove spring:

- 1) Disconnect power to the unit.
- 2) Remove cover.
- 3) Remove motor.
- 4) Remove camshaft.
- 5) Place unit in bypass.
- 6) Release water pressure by pushing the last valve discs open with a screwdriver.
- 7) Locate valve discs 3, 4 and 5.
- 8) Position yourself on the spring side of the valve discs.
- 9) Place two (or more) fingers on the flat part of the spring.
- 10) Move the fingers toward the valve discs and into the spring valley between the previously located valve discs.
- 11) By pulling back and up on the spring, the spring will pop out of the valley.
- 12) Pull back further to remove the spring.

To install spring:

- 1) Inspect the spring for damage. Do not attempt to repair a bent spring.
- 2) Position yourself on the spring side of the valve discs.
- 3) Position the spring over the valve body close to final position. The wide spring segments will be located at the wide valve discs. The curve of the spring will be down into the valve.

The long flat close edge is inserted first. This edge slides into a channel on the valve body.

The spring will slide off the top of the valve disc downward. The small projection on the end of the spring will drop into the hole in the valve disc to provide secure positioning. Repeat for all spring segments.

NOTE: If a spring segment goes beyond the locating hole, it can be pulled back using a small flat blade screwdriver.

NOTE: In high pressure (80 psi and higher) applications, the standard single valve disc springs can be installed on top of the one piece spring.

- 4) Rock the spring back and place the flat edge into the channel.
- 5) Lower the springs until they rest on top of the valve discs.

A tool (Phillips screwdriver) will be needed to push the springs in place.

The spring posts will guide the spring into place.

- 6) Hold the flat part down with one hand.
- 7) Spread your fingers apart to cover the length and push down.
- 8) With the other hand use the tool to push down in the valley of each spring segment.

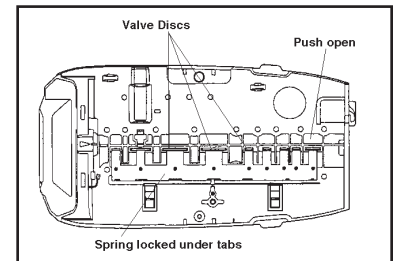

Figure 34

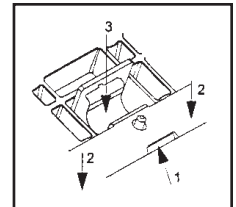

Figure 35

TOP PLATE

The top plate holds the valve discs in place during operation. This plate is removed to allow cleaning and replacing the valve discs.

IMPORTANT NOTE

The valve discs are made from a chloramine resistant severe service rubber. The valve discs will usually not need to be changed. Before removing the top plate for valve disc service be certain that one of the discs is not operating correctly.

To remove top plate:

- 1) Disconnect power to unit.
- 2) Remove cover.
- 3) Remove motor.
- 4) Remove camshaft.
- 5) Place unit in bypass.
- 6) Release water pressure by pushing the last valve disc open with a screwdriver.
- 7) Any optional items may be removed.
- 8) Wiring harnesses should be removed.
- 9) Remove valve disc spring.
- 10) Use a Phillips screwdriver to remove the screws from the top plate.
- 11) Lift the top plate off. All the valve discs can be pulled straight out.

Inspect valve discs for wear. The sealing surface is the raised ridge on the underside of the top shoulder.

Check each valve disc cavity in the valve for debris. Remove any foreign objects before replacing the valve disc.

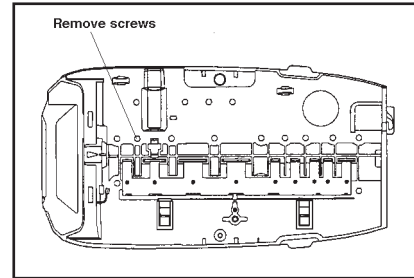

Figure 36

To install valve discs:

NOTE: If the valve disc fits properly in the cavity, it will work correctly.

- 1) Put the valve disc into the correct (based on shoulder size) valve port cavity. The metal end without rubber coating should be visible.
- 2) Push down on the shoulder to position the valve disc completely into the port cavity.

The metal portion will be positioned straight up and the top of the shoulder will be level with the valve.

To install the top plate:

NOTE: All valve discs should be in position. Use the same screws that were removed to reassemble the top plate.

IMPORTANT NOTE

Follow the procedure to engage the screws with the existing threads. If the same threads are not used, the holding power of the screw is lost. Under pressure the valve can leak. Screws that have the same diameter but have different threads should not be used.

- 1) Position the top plate on top of the valve and over the valve discs.
- 2) Insert a screw at one of the corner positions.
IMPORTANT: This procedure for reinserting screws must be followed to ensure proper holding strength of the screws.
 - A. Drop screw of same size and thread into the hole.
 - B. Use a Phillips screwdriver and lightly rotate the screw backwards
 - C. When the thread of the screw and thread of the hole match, the screw will "click" and slightly drop down.
 - D. The threads are lined up. Lightly rotate the screw to tighten and engage threads.
 - E. Once the threads have engaged the screw can be tightened. Minimal resistance will be present as the screw is turned in. Resistance indicates new threads are being formed. Back the screw out and rematch the threads.
- 3) Turn the screw in but do not tighten.
- 4) Place a second screw into the hole diagonally opposite the first screw and turn in but do not tighten.
- 5) Insert another screw into one of the remaining corners and turn it in.
- 6) The fourth screw goes into the hole diagonally opposite. Turn it in.
- 7) Put the remaining screws in following the same crisscross pattern working from the ends toward the center. When all the screws are in place they can be tightened down.
- 8) Start at the corner of the screw pattern and tighten that screw. Work the same pattern from the ends toward the center and crisscrossing as each screw is tightened. Check that each valve disc moves smoothly before replacing the spring and camshaft.
- 9) Replace spring.

- 10) Replace camshaft and motor.
- 11) Replace controller and wiring harnesses.

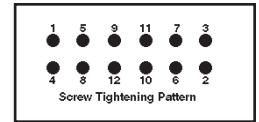

Figure 37

MAINTENANCE

IMPORTANT NOTE:

Many of the maintenance procedures involve o-rings. When reassembling two parts with an o-ring seal, care must be taken with the placement of the o-ring. To properly install o-rings, they should be lightly lubricated with silicone. Place the o-ring over the part feature that will be inserted into the hole. Do not start the assembly with the o-ring in the hole.

Injector Screen and Injector

Inspect and clean brine tank and screen filter on end of brine pickup tube once a year or when sediment appears in the bottom of the brine tank.

Clean injector screen and injector once a year.

- 1) Unplug the wall-mount transformer.
- 2) Remove cover. Shut off water supply or put bypass valve(s) into bypass position.
- 3) Relieve system and valve pressure by using a screwdriver to press valve disc #7 slightly open. The pressure will escape quickly.
- 4) Using a T-50 torx driver (recommended), or large flat blade screwdriver, remove injector screen and injector cap.
- 5) Clean injector screen using a fine brush. Flush under running water until clean.
- 6) Using a needle-nose pliers, pull injector straight out.

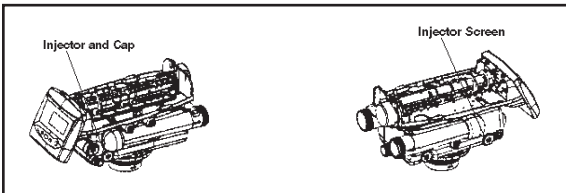

Figure 38

- 7) Flush water into the injector screen recess of the valve body to flush debris out through the injector recess.
- 8) Clean and flush the injector with water. Inspect for any debris in the venturi.
- 9) Lubricate the o-rings on the injector, injector cap and injector screen with silicone lubricant only!
- 10) Reinstall the injector, injector cap and injector screen. Be careful not to crimp or bend the o-rings.

CAUTION

To reduce the risk associated with property damage due to water leakage:

- **Do not** use a torch or other high temperature sources near filter system, cartridges, plastic fittings or plastic plumbing.
- On plastic fittings, never use pipe sealant or pipe dope. **Use PTFE thread tape only**, pipe dope properties may deteriorate plastic.
- Take care when using pliers or pipe wrenches to tighten plastic fittings, as damage may occur if over tightening occurs.

- 11) Plug the wall-mount transformer into outlet; reset clock if necessary.
- 12) Slowly open water supply valve or return bypass valve(s) to the “service” position.

WATER METER MAINTENANCE

Demand Systems

The valve metering devices are used with the demand controls, and may require simple maintenance. In rare instances, the turbine wheel of the water meter can collect small particles of oxidized iron, eventually preventing the wheel from turning.

- 1) Shut off the water supply or put the bypass valve(s) into the bypass position.
- 2) Relieve pressure by opening the backwash drain valve (the seventh back from the controller) with a screwdriver.
- 3) Loosen and remove the pipe/tube adapters or bypass from the inlet and outlet of the valve body.
- 4) Using a needle-nose pliers, remove the turbine from the outlet housing. Grasp one of the four vanes of the outer gland and pull straight out to remove turbine assembly from the outlet of the valve.
- 5) Carefully remove the turbine wheel from the housing. Use a toothbrush to lightly scrub debris or iron off the magnet. Iron build-up on the surfaces can be reduced by soaking the wheel in mild sodium hydrosulfite solution for a few minutes. Flush thoroughly with water.
- 6) Carefully reinstall the turbine wheel into the turbine cage housing. Make sure that the shaft of the wheel seats into the bearing of the cage. Reassemble the turbine cage and check that the wheel rotates freely.
- 7) Reinstall the turbine cage into the outlet of the valve.
- 8) Reinstall the pipe/tube adapters or bypass to the inlet and outlet of the valve.
- 9) Turn on the water supply or put the bypass valve(s) into the service position and purge the air out of the system.
- 10) The system will require the startup procedure to be performed in order to operate appropriately.

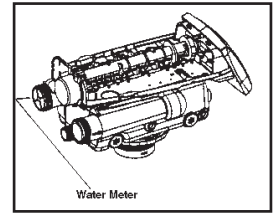

Figure 39

CHECK TURBINE OPERATION

After the turbine has been cleaned, verify that the turbine is accurately working. Repressurize the conditioner system, and verify that the controller is plugged in. Completely turn on a faucet that is plumbed after the conditioning system. After a few seconds, the display should be flashing a small faucet icon with water drops. If this is flashing, the turbine is operating properly.

If the faucet icon does not flash, then the system may have a faulty turbine probe cable wire harness. Replace that harness and repeat the steps above for checking for turbine operation.

REFILL FLOW CONTROL

If the brine tank is not refilling correctly (too much or too little water) the refill flow control should be cleaned and inspected.

To clean the refill flow control:

- 1) Place unit in bypass. Relieve water pressure by pushing open one of the last two valve discs.
- 2) Remove cap.
- 3) Pull refill flow control parts out.
- 4) Inspect parts for damage.
- 5) Flush with water and clean with soft brush.
- 6) Replace refill flow control parts.
- 7) Replace cap (hand tight).

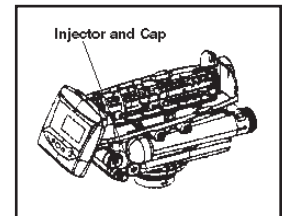

Figure 40

DRAIN FLOW CONTROL

If the unit is not supplying conditioned water for as long as when it was first setup, then the drain flow control should be cleaned.

To clean the drain flow control:

- 1) Place unit in bypass. Relieve water pressure by pushing open one of the last two valve discs.
- 2) Remove the drain flow control and ball.
- 3) Inspect parts for damage.
- 4) Flush with water and clean with soft brush.
- 5) Orifice should be open not plugged.
- 6) Replace ball and drain flow control (hand tight).

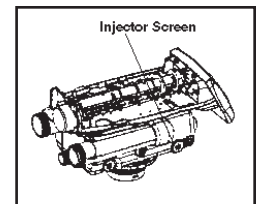

Figure 41

AFTER SERVICE START-UP

Whenever the controller is unplugged or the system is put in bypass for maintenance, a start-up is required. This start-up is not normally as extensive as the new system start-up procedure needs to be followed.

The initial power-up procedure should be used if a new controller or a new valve has been installed. This procedure is explained in the users manual.

The following service start-up procedure can be used when the controller was programmed prior to servicing the unit and removing power. The unit should be fully assembled with the cover off.

To start-up after service:

1) Plug the transformer into the controller. Resin/media volume should not need to be entered. If the display is flashing three dashes and a decimal point, contact the factory.

2) Set time of day and day of week if necessary.

NOTE: Time of day and day of week settings are stored in a temporary memory and will be maintained at least 8 hours.

The display will flash four dashes and a colon if the time of day needs to be set. If the display shows the correct time, proceed to step 5.

3) The UP and DOWN arrows are used to set the time of day. When the correct time is displayed push SET. If using the 12 hour setting PM will be displayed behind the time. AM is not designated.

4) Use the UP and DOWN arrow buttons to move a small flag (box) at the top of the display under the day of the week. When the correct day is flagged push SET.

The controller is ready to operate. The media tank should be ready for operation.

5) Hold the REGEN button on the controller down for five seconds. This will initiate a manual regeneration. The controller will indicate that the motor is turning the camshaft to the C1 cycle (Backwash) position. The display will show the total regen time remaining and the hourglass will flash when the motor is running.

6) Open the supply valve to the 1/4 open position. Any air in the media tank and valve will escape from the valves' drain line.

7) Open supply valve to full open.

8) Advance the controller to the Refill Position. From cycle C1 (Backwash), press and hold the SET button. This will display the current cycle. Press the UP arrow to advance to the next cycle.

Continue to advance through each cycle until you have reached cycle C9 (Refill).

NOTE: As you advance through each cycle there will be a slight delay before you can advance to the next cycle. The hourglass icon will flash while the camshaft is indexing to each cycle. There may be a pause at cycle C4 (System Pause). This cycle allows the water pressure to equalize on each side of the valve discs before moving on to the next cycle. The hourglass will flash indicating that the system is paused.

9) Allow a small amount of water to flow into the brine tank. Press SET and UP buttons simultaneously to advance to the treated water position.

10) Turn on a faucet and run the water until it is clear.

The unit is ready for operation.

SECTION 5: PERFORMANCE DATA SHEET

Model Number	AWS100M	AWS150M	AWS200M	AWS300M
Rated Service Flow (gpm)	11.2	14	12.7	17
Pressure Drop at Rated Service Flow Rate (psi)	15	15	15	15
Rated Softening Capacity (Grains) Low Salt Setting Standard Salt Setting High Salt Setting	15,115 @ 3.5 lbs salt 27,403 @ 9 lbs salt 29,346 @ 15 lbs salt	22,053 @ 5 lbs salt 41,432 @ 13.5 lbs salt 44,536 @ 22.5 lbs salt	28,864 @ 6.5 lbs salt 55,243 @ 18 lbs salt 59,381 @ 30 lbs salt	44,106 @ 10 lbs salt 82,864 @ 27 lbs salt 89,072 @ 45 lbs salt
Efficiency at Low Salt setting (Grains/lbs salt)	4,319	4,411	4,441	4,411
Min.-Max. Working Pressure (psi)	20-125	20-125	20-125	20-125
Min.-Max. Operating Temperature (°F)	40-110	40-110	40-110	40-110
Max. Flow Rate (gpm) to Drain During Regeneration Cycle	1.6	2.5	2.5	4.8
Amount of High Capacity Resin (cu ft)	1	1.5	2	3
Media Tank Diam. x H, in (cm)	8 x 44 (20 x 112 cm)	10 x 44 (25 x 112 cm)	10 x 54 (25 x 137 cm)	14 x 65 (36 x 165 cm)
Overall Height D x H with valve, in (cm)	15 x 61 (38 x 155)	15 x 61 (38 x 155)	15 x 63 (38 x 160)	15 x 74 (38 x 188)
Brine Tank, W x D x H in (cm)	15 x 15 x 34 (38 x 38 x 86)	15 x 15 x 34 (38 x 38 x 86)	15 x 15 x 34 (38 x 38 x 86)	18 x 33 Round (26 x 84)
Approx Salt Storage, lbs (kg) With Salt Grid Leg Extensions Without Salt Grid Leg Extensions	N/A 180 (81)	135 (61) 180 (81)	135 (61) 180 (81)	225 (102) 300 (136)
Approximate Shipping Weight, lbs (kg)	100 (45.4)	125 (56.7)	150 (68)	300 (136.1)

SECTION 6: TROUBLESHOOTING

PROBLEM	CAUSE	SOLUTION
1. ERR 1 displayed	A. Controller power has been connected and the control is not sure of the state of operation.	A. Press the UP arrow and the control should reset.
2. ERR 2 displayed	A. Controller power does not match 50 or 60 Hz.	A. Disconnect and reconnect the power. B. If problem persists, obtain the appropriate controller for either 50 or 60 Hz power.
3. ERR 3 displayed	A. Controller does not know the position of the camshaft. Camshaft should be rotating to find home position.	A. Wait for 2 minutes for the controller to return to HOME position. The hourglass should be flashing on the display indicating the motor is running.
	A. Camshaft is not turning during ERR 3 display	A. Check that motor is connected
		B. Verify that motor wire harness is connected to motor and the controller module.
		C. Verify that optical sensor is connected and in place.
		D. Verify that motor gear has engaged cam gear.
		E. If everything is connected, try replacing in this order: - Wire harness - Motor - Optical sensor - Controller
A. If camshaft is turning for more than 5 minutes to find HOME position.	A. Verify that optical sensor is in place and connected to wire. B. Verify that camshaft is connected appropriately. Verify that no dirt or rubbish is clogging any of the cam slots. C. If motor continues to rotate indefinitely, replace the following components in this order: - Optical sensor - Wire Harness - Motor - Controller	
4. Brine tank overflow.	A. Uncontrolled brine refill flow rate.	A. Remove brine control to clean ball and seat.
	B. Air leak in brine line to air check.	B. Check all connections in brine line for leaks. Refer to instructions.
	C. Drain control clogged with resin or other debris.	C. Clean drain control.
5. Flowing or dripping water at drain or brine line after regeneration.	A. Valve stem return spring weak.	A. Replace spring.
6. Hard water leakage after regeneration.	A. Improper regeneration.	A. Repeat regeneration after making certain correct salt dosage was set.
	B. Leaking of external bypass valve.	B. Replace bypass valve.
	C. O-ring around riser pipe damaged.	C. Replace o-ring.
7. Control will not draw brine.	A. Low water pressure.	A. Set pump to maintain 20 psi at softener.
	B. Restricted drain line.	B. Change drain to remove restriction.
	C. Injector plugged.	C. Clean injector and screen.
	D. Possible problem with injector.	D. Replace injector.
	E. Air check valve closes prematurely.	E. Put control momentarily into brine/slow rinse. Replace or repair air check if needed.
	F. Valve disc 2 and/or 3 not closed.	F. Remove foreign matter from disc and check disc for closing by pushing in on stem. Replace if needed.
8. Clock does not display time of day.	A. Transformer cord unplugged.	A. Connect power.
	B. Problem with transformer.	B. Replace transformer.
	C. Problem with circuit board.	C. Replace timer.

9. Clock does not display correct time of day.	A. Electrical outlet operated by switch.	A. Use electrical outlet not controlled by switch.
	B. Incorrect voltage or frequency (Hz).	B. Replace timer with one of correct voltage and frequency (Hz) (Contact Dealer).
	C. Power outages.	C. Reset clock.
10. No water flow display when water is flowing.	A. Bypass valve in bypass.	A. Shift bypass valve to not-in-bypass position.
	B. Meter probe disconnected or not fully connected to meter housing.	B. Fully insert probe into meter housing.
	C. Restricted meter turbine rotation due to foreign material in meter.	C. Remove meter housing, free up turbine and flush with clean water. Turbine should spin freely, if not, replace meter.
	D. Problem with meter probe.	D. Replace harness.
	E. Problem with circuit board.	E. Replace timer.
11. Control will not regenerate automatically or when button is pressed.	A. Electrical cord or transformer unplugged.	A. Connect power.
	B. Problem with motor.	B. Replace motor.
12. Control regenerates at wrong time of day.	A. Power outages.	A. Reset clock to correct time of day.
	B. Clock set incorrectly.	B. Reset clock to correct time of day.
13. Intermittent or irregular brine draw.	A. Low water pressure.	A. Set pump to maintain 20 psi at softener.
	B. Possible problem with injector.	B. Replace injector and cap.
14. System using more or less salt than salt control is set for.	A. Inaccurate setting.	A. Make correct setting.
	B. Foreign matter in controller causing incorrect flow rates.	B. Remove salt controller and flush out foreign matter. Manually index control to brine/slow rinse and allow unit to proceed through complete regeneration.
	C. Problem with controller.	C. Replace part.
15. No conditioned water after regeneration	A. No salt in brine tank.	A. Add salt to brine tank.
	B. Injector plugged.	B. Clean injector and injector screen.
	C. Air check valve closes prematurely.	C. Put control momentarily into refill to free air check. Replace or repair air check if needed.
	D. Unit did not regenerate.	D. Check for power.
16. Control will not regenerate automatically but will regenerate when button is pushed.	A. If water flow display is not operative, refer to Problem 10.	A. Same as Problem 10.
	B. Problem with circuit board.	B. Replace timer.
	C. Incorrect hardness and capacity settings.	C. Set to correct values.
17. Run out of soft water between regenerations	A. Improper regeneration.	A. Repeat regeneration, making certain that correct salt dosage is used.
	B. Incorrect salt settings.	B. Set control to proper level. See Specifications.
	C. Incorrect hardness.	C. Set to correct values.
	D. Water hardness has increased.	D. Set hardness to new value.
	E. Restricted meter turbine rotation due to foreign material in meter.	E. Remove water housing, free up turbine and flush with clean water. Turbine should spin freely; if not, replace meter.

SECTION 7: PARTS
COMPONENT PARTS LIST
METERED SOFTENER MODELS (AWS SERIES)

REF	DESCRIPTION	AWS100M	AWS150M	AWS200M	AWS300M
1	Control Valve, Timer & Cover (AWS-M)	VAM-X-7SB-C	VAM-X-5SB-C	VAM-X-5SB-C	VAM-X-8SB-C
1a	O-ring	43F	43F	43F	43F
2	Media Tank w/Base	6236001-0844	6236001-1044	6236001-1054	MTP1465B
3	Media	H-10P	H-010P & H-050P	H-10P (x2)	H-10P (x3)
4	Turbulator	6236232	6236232	6236233	C04N-65
5	Brine Line Tubing	13000X	13000X	13000X	13000X
6	Brine Tank, Complete	BT1534X	BT1534X	BT1534X	BTCS33BK
7	Overflow Fitting	BT16	BT16	BT16	BT16
8	Brine Tank Shell w/Cover	BT1534L	BT1534L	BT1534L	BT1833BK
9	Brine Well w/Cap	BT15BW	BT15BW	BT15BW	B1030-28
10	Grid Plate	BT15GP	BT15GP	BT15GP-EXT	BTCS12-18
11	Safety Brine Valve, Complete	10002X	10002X	10002X	10002X
12	Safety Brine Valve	60014	60014	60014	60014
13	Float Assembly	60068X	60068X	60068X	60068X
14	Air Check Assembly	60002	60002	60002	60002
15	Bypass Valve (Incl. Ref. 20)	1040930	1040930	1040930	1040930
16	Bypass Drain Ftg, 3/4" Barb x FPT	1002449	1002449	1002449	1002449

NOTE: When ordering components, always specify model number.

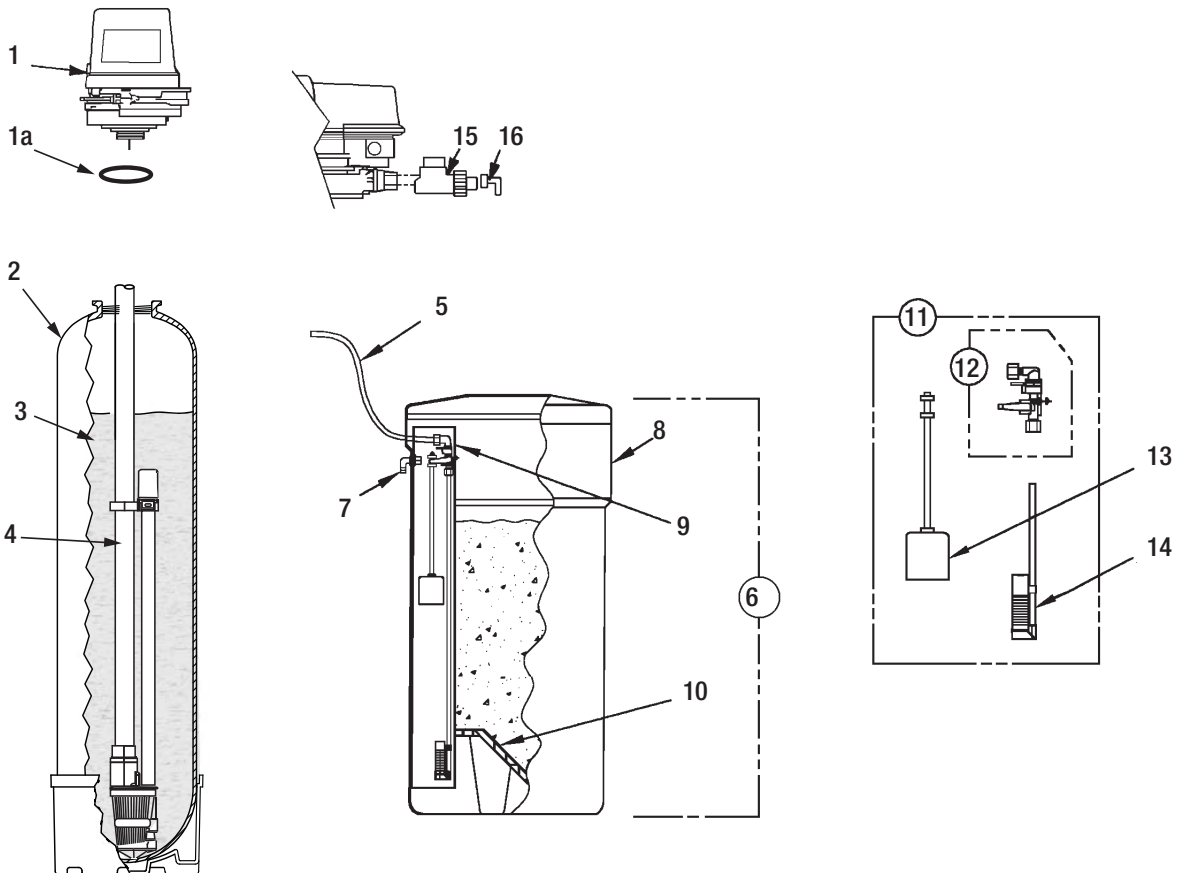

VALVE EXPLODED VIEW

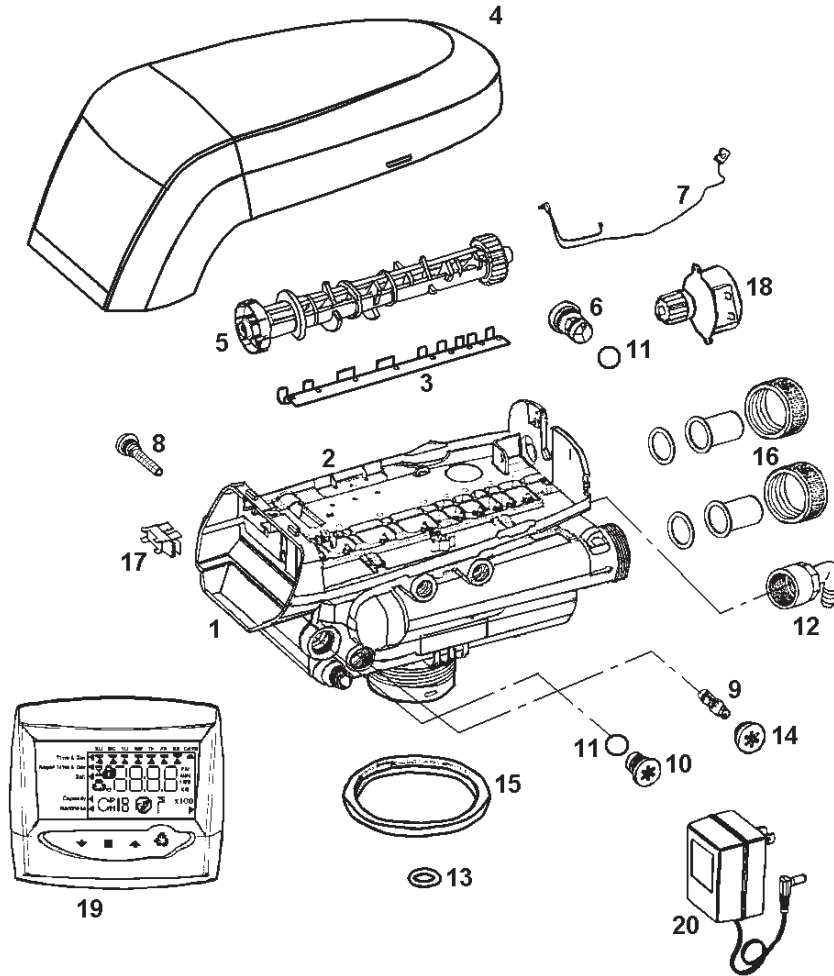

VALVE PARTS LIST

**ONLY THOSE PARTS REFERENCED IN DRAWING ARE STOCK ITEMS
ALL OTHERS ARE SPECIAL ORDER, NON-RETURNABLE**

REF	PART NO.	DESCRIPTION
1	1035807	Valve Assembly w/o Flow Controls
2	1235338	Top Plate (Not Shown)
3	1235339	Valve Disc Spring, One Piece
4	1236246	Valve Cover
5	1235352	Cam, STD, Black
6	25F-8 25F-10 25F-12 25F-14	Drain Control Assembly: No. 8 (1.6 gpm; 6.1 lpm) No. 10 (2.5 gpm; 9.5 lpm) No. 12 (3.5 gpm; 13.2 lpm) No. 14 (4.8 gpm; 18.2 lpm)
7	1235269	Motor/Optical Cable Assembly
8	1000226	Screen/Cap Assembly w/O-ring Injector (High Efficiency) Options
9	1030410 1030412 1035736	"G" Injector (High Efficiency) - Tan "J" Injector (High Efficiency) - Lt. Blue "L" Injector (High Efficiency) - Orange

REF	PART NO.	DESCRIPTION
10	1243510	Regenerant Refill Controller
11	1030502	Ball, Refill Flow Control
12	1002449	Drain Fitting Elbow (3/4 inch hose barbed)
13	1010428	O-ring
14	1000269	Injector Cap with O-ring
15	1035622	Tank Ring
Ref.	104117	Valve Disc Kit: Standard (Not Shown)
16	1001670	1 inch Copper Tube Adapter Kit (Incl. Adapters, Gasket and Nuts)
17	1235373	Module, Sensor, Photo Interrupter
18	1235361	Motor w/Spacer and Pinion, 12V, 50/60 Hz
19	1242163	Controller
20	1000812	Transformer

SECTION 8: LIMITED WARRANTY

Limited Warranty: 3M Purification Inc. warrants this Product to be free from defects in material and workmanship during normal use for the warranty period set forth below. The warranty period commences from the date of purchase. This warranty does not cover failures resulting from abuse, misuse, alteration or damage not caused by 3M Purification Inc. or failure to follow installation and use instructions. No warranty is given as to the service life of any filter cartridge, membrane, or media as it will vary with local water conditions and water consumption.

3M PURIFICATION INC. MAKES NO OTHER WARRANTIES OR CONDITIONS, EXPRESS OR IMPLIED, INCLUDING, BUT NOT LIMITED TO, ANY IMPLIED WARRANTY OR CONDITION OF MERCHANTABILITY OR FITNESS FOR A PARTICULAR PURPOSE OR ANY IMPLIED WARRANTY OR CONDITION ARISING OUT OF A COURSE OF DEALING, CUSTOMER OR USAGE OF TRADE.

If the Product is found defective within the warranty period, your exclusive remedy and 3M Purification Inc.'s sole obligation shall be, at 3M Purification Inc.'s option, to replace or repair the Product or refund the purchase price of the Product. This warranty does not cover labor. The remedy stated in this paragraph is Customer's sole remedy and 3M Purification Inc.'s exclusive obligation.

Warranty Period:

- One (1) year on the entire product unit
- Five (5) years on the mineral tank only (does not include internal component parts)
- Five (5) years on the control valve
- Five (5) years on salt storage container and components*

Limitation of Liability: 3M Purification Inc. will not be liable for any loss or damage arising from this 3M Purification Inc. product, whether direct, indirect, special, incidental, or consequential, regardless of the legal theory asserted, including warranty, contract, negligence or strict liability. Some states and countries do not allow the exclusion or limitation of incidental or consequential damages, so the above limitation or exclusion may not apply to you.

Warranty Claims:

To obtain warranty service, call 1-800-222-7880 or mail your request to: 3M Purification Inc., 400 Research Parkway, Meriden, CT 06450. Proof of purchase (original sales receipt) must accompany the warranty claim, along with a complete description of the Product, model number and alleged defect. **This warranty gives you specific legal rights, and you may have other rights which may vary from state to state, or country to country.**

* Water Softeners only



3M Purification Inc.
400 Research Parkway
Meriden, CT 06450
1-800-222-7880
www.3Mpurification.com

3M is a trademark of 3M Company.
Aqua-Pure is a trademark of 3M Company used under license.
© 2011 3M Company. All rights reserved.