



Model 8826 System Controller Installation, Configuration and User Manual

READ AND SAVE THESE INSTRUCTIONS

WELCOME

Thank you for choosing the Aprilaire® HVAC Automation System. With this system you have taken the first step towards total control of a building's heating and air-conditioning system. This simple to use, yet powerful system, provides centralized control of all of the buildings thermostats with an intuitive graphics based software package. The software can be accessed via any computer allowing the means to manage comfort and control the energy costs that the heating and cooling equipment represent.

TABLE OF CONTENTS

Technical Support	2	Adding HVAC and Humidity Control Equipment	11
System Controller Package Contents	2	Configuring Thermostats and Humidistats	11
System Pre-requisites	3	Naming the Thermostats/Humidistats	12
Other Useful Documents	3	Assigning Heating and Cooling Equipment (Thermostat Only) . . .	12
Installation Steps	3	Lockouts	12
Step 1: Mount the System Controller	3	Service Reminders (Model 8800 Thermostats Only)	12
Step 2: Provide Power to the System Controller	3	Sensors	13
Step 3: Connect the System Controller to the Distribution Panel	4	Security	14
Step 4: Connect the System Controller to a Network or Computer	4	Humidistat Set-up	15
Configuring the System Controller for your		Thermostat Set-up	15
Network or Computer	4	Scheduling	16
On Windows Computers	4	Master Schedules	16
Changing your IP Address	5	Holidays	17
For Windows XP	5	Holds	18
For Windows 7	6	Individual Holds	18
Change your IP Address on your System Controller		Status	19
to Match your Network Settings	7	Setting Alarms	20
To Restore your Computer's IP Address	8	Alarms	21
For Windows XP	8	E-mail Alerts	21
For Windows 7	9	Service Reminders	22
System Set-up	10	Firmware Update	24
Temperature Format	10	LED Diagnostics	25
Service Override	10	Limited Warranty	26
Time and Date	10	Warranty Registration	26
Number of Thermostats on the Network	10	System Requirements	27
Naming the System Controller	10		
System Status Bar	10		

TECHNICAL SUPPORT

If you have any questions or concerns regarding the installation or operation of this system, DO NOT take the product back to your distributor. Please contact Aprilaire at 888-782-8638 for system integrator support.

You may need to work with an IT professional to properly configure your e-mail settings and/or configure your network to provide access to the System Controller from outside your local network.

SYSTEM CONTROLLER PACKAGE CONTENTS

1. The Model 8826 System Controller
2. Power Supply
3. Installation, Configuration and User Manual
4. Eight Position Connector for wiring the System Controller to the Distribution Panel

SYSTEM PRE-REQUISITES

These instructions assume that you have already installed the thermostat(s) and wired them to the Distribution Panel according to the Model 8800 System Installation Instructions (Document 10009416).

If your thermostats are configured as non-programmable, all schedules are stored in the System Controller and setpoints are written out to the thermostats at the beginning of each schedule event. If the thermostats are configured as programmable, the schedules are stored in the thermostats. This is advantageous because if communication to the System Controller is disrupted, the thermostats will continue to run the programmed schedule.

In programmable mode, Progressive Recovery can be enabled at the thermostat. The Progressive Recovery feature allows the thermostat to activate the heating and cooling equipment **PRIOR** to a scheduled event in order to reach the desired temperature at the start of that scheduled event. **Example:** If the WAKE time is 6 am, and the temperature is 70°, the heat will come on before 6 am, so the temperature is 70° by the time you wake at 6 am.

IMPORTANT NOTE: Set the thermostat ID numbers to consecutive numbers beginning at 1.

OTHER USEFUL DOCUMENTS

The following documents will be useful in installation and setup of a system using Model 8870 thermostats:

Model 8870 Installation Instructions (Document 61000494)
Model 8870 Operating Instructions (Document 61000491)
Model 8061 TT Support Module Installation Instructions
Model 8062 TrH Support Module Installation Instructions
Model 8870 System Installation Instructions (Document 10008222)
Model 8870 Programmer's Manual (Document 10005756)

The following documents will be useful in installation and setup of a system using Model 8800 thermostats:

Model 8800 Installation Instructions (Document 61000761)
Model 8800 Operating Instructions (Document 61000762)
Model 8081/8082 Support Module Installation Instructions (Document 61000793)
Model 8800 System Installation Instructions (Document 10009416)
Model 8800 Programmer's Manual (Document 10009414)

INSTALLATION STEPS

To install the System Controller you will need to complete the following steps, which are described in the following sections:

1. Mount the System Controller in a suitable location.
2. Connect the System Controller to a network or computer.
3. Connect the System Controller to a Distribution Panel.
4. Connect power to the System Controller using the included power supply.

STEP 1: MOUNT THE SYSTEM CONTROLLER

The System Controller should be mounted to a wall at a location that:

- Provides access to a power outlet.
- Provides access to an Ethernet network connection if you plan to access the System Controller over a network.
- Provides access to wire the RS-485 communications to the distribution panel.

The System Controller should be mounted in a dry location that maintains normal temperatures between 40°F and 100°F.

The System Controller does not need to be accessed in normal operation, but should be accessible for servicing.

STEP 2: PROVIDE POWER TO THE SYSTEM CONTROLLER

The System Controller comes with a power adapter that plugs into a normal 120VAC outlet. Simply plug the power adapter into an electrical outlet and connect the power plug to the 5 position connector on the 8826. It is highly recommended to use a surge protected uninterruptible Power Supply to power the 8826.

Illumination of the Power LED on the System Controller indicates power has been established.

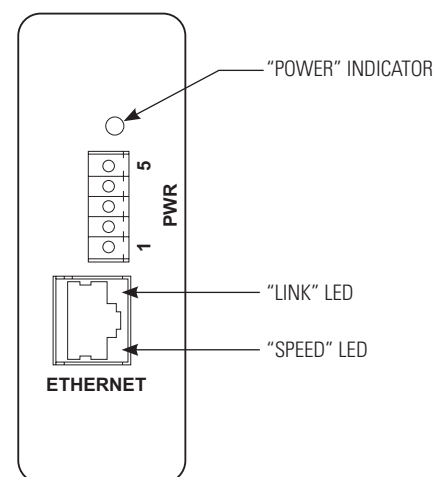

STEP 3: CONNECT THE SYSTEM CONTROLLER TO THE DISTRIBUTION PANEL

The System Controller connects to the distribution panel on the Thermostat port. The wiring is done as follows:

Thermostat Port	Distribution Panel
Pin 4	B+
Pin 5	B-
Pin 6	A+
Pin 7	A-

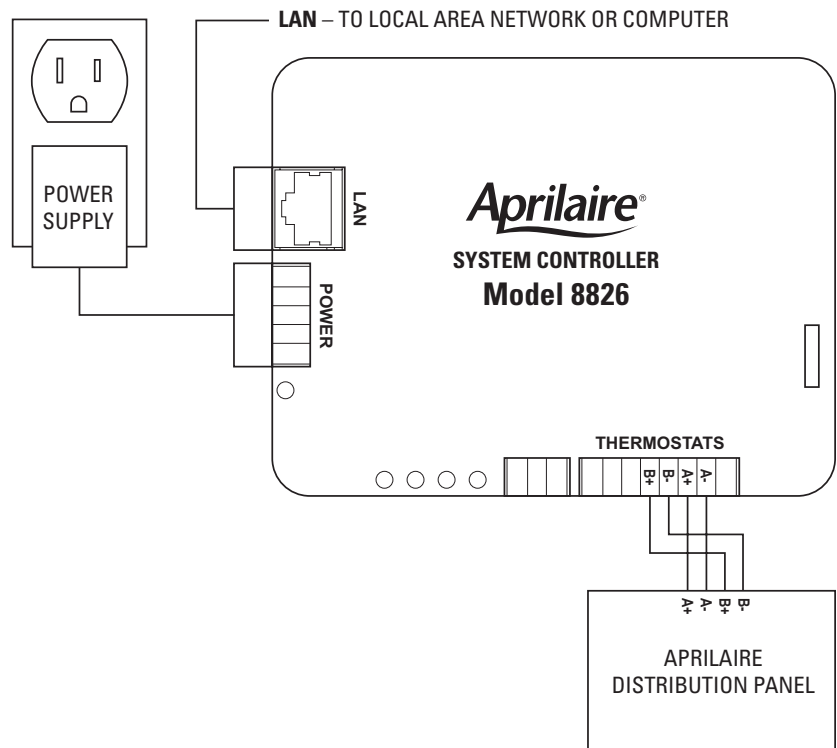

STEP 4: CONNECT THE SYSTEM CONTROLLER TO A NETWORK OR COMPUTER

There are two methods to connect a computer to the System Controller; directly to a computer (with a crossover Ethernet cable) or using a local area network (with a standard Ethernet cable).

If there is no network available, then the System Controller is connected to a computer using a crossover cable. Plug one end of the crossover cable into the System Controller and the other end into the computer's network port.

If there is a network available, then use a standard Ethernet cable, plugging one end into the System Controller and the other into an available Ethernet network jack.

CONFIGURING THE SYSTEM CONTROLLER FOR YOUR NETWORK OR COMPUTER

Once you have completed the installation of the System Controller you are ready to configure the System Controller for use on your network or with your computer.

The System Controller is sent from the factory with a default fixed IP address of 192.168.0.100. If your computer has an IP address that begins with 192.168.0 then proceed to the System Set-up section. If you don't know the IP address of your computer, then proceed as follows:

ON WINDOWS COMPUTERS:

- 1a. For Windows XP, click on Start, Run to bring up the run dialog similar to that shown at the right.
- 1b. For Windows Vista and 7, click on Start and then in the Search Programs and Files type "run" to bring up the run dialog similar to that shown on the right.

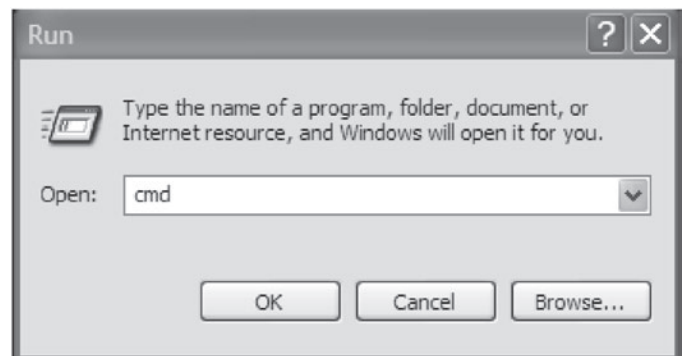

2. Type **cmd** and then click OK: this will bring up the command prompt similar to that shown at right:

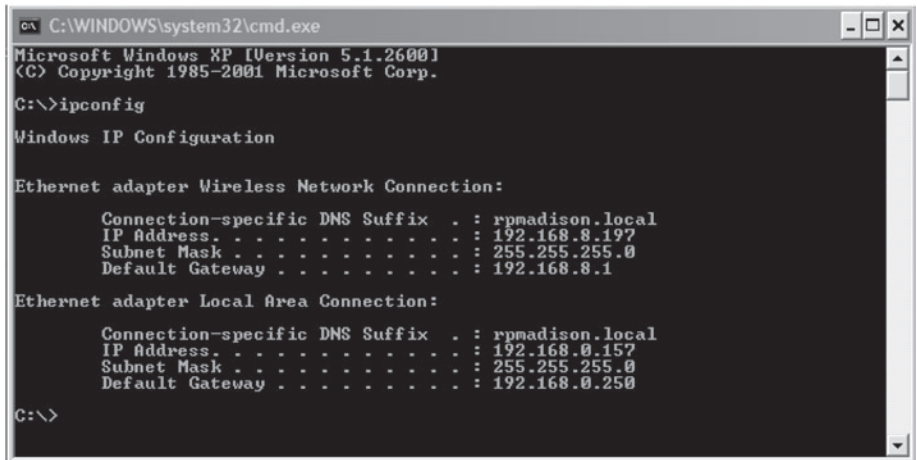

```
C:\WINDOWS\system32\cmd.exe
Microsoft Windows XP [Version 5.1.2600]
(C) Copyright 1985-2001 Microsoft Corp.

C:\>ipconfig

Windows IP Configuration

Ethernet adapter Wireless Network Connection:

    Connection-specific DNS Suffix  . : rpmadison.local
    IP Address . . . . . : 192.168.8.197
    Subnet Mask . . . . . : 255.255.255.0
    Default Gateway . . . . . : 192.168.8.1

Ethernet adapter Local Area Connection:

    Connection-specific DNS Suffix  . : rpmadison.local
    IP Address . . . . . : 192.168.0.157
    Subnet Mask . . . . . : 255.255.255.0
    Default Gateway . . . . . : 192.168.0.250

C:\>
```

3. Type **ipconfig** and press Enter: several lines including the IP Address of the Local Area Connection will be displayed, as shown above.

CHANGING YOUR IP ADDRESS

If your computer's IP address begins with 192.168.0 then you can skip this step.

If your computer's IP address does not begin with 192.168.0 then you need to temporarily change your computer to connect to the System Controller and change its settings to match your network.

In the following procedure we will change your computer's IP address so that you can communicate with the System Controller. Once this step is completed, you can then connect to the System Controller to change its IP address to match your network.

FOR WINDOWS XP

1a. Start the Control Panel by clicking Start, then Settings and Control Panel. In the Control Panel, locate and double click Network Connections to bring up Network Connections dialog, shown below. Select Local Area connection and then go to File and select Properties to bring up the Local Area Connection Properties dialog box on the right, below.

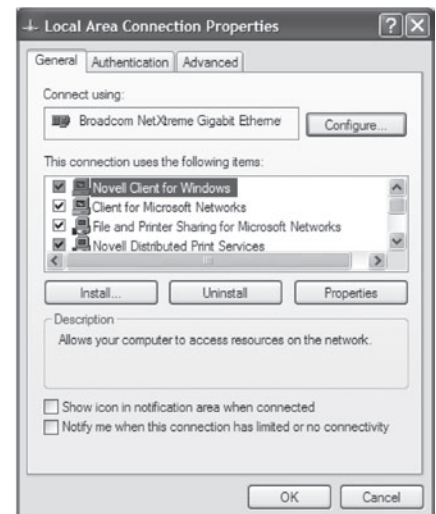
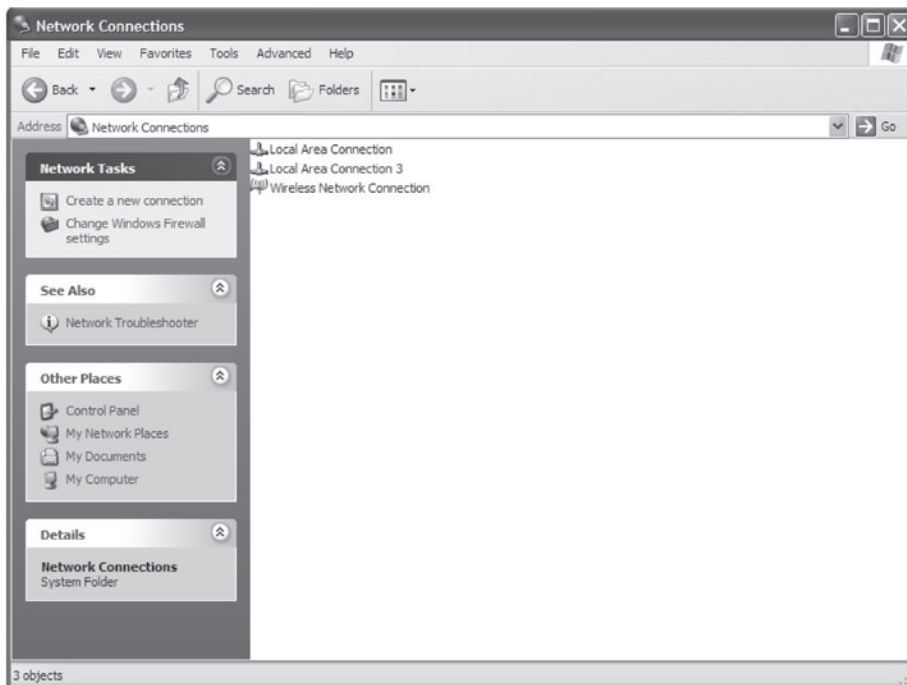

FOR WINDOWS 7

- 1b. Start the Control Panel by clicking Start, then Control Panel. In the Control Panel, locate and double click Network and Sharing Center to bring up Network and Sharing dialog, shown below. Double click on Local Area connection and then select Properties to bring up the Local Area Connection dialog box on the right, below.

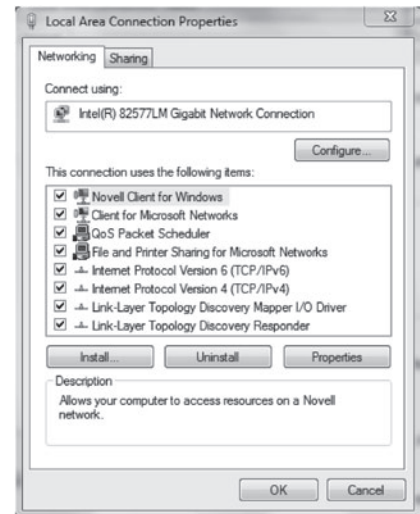
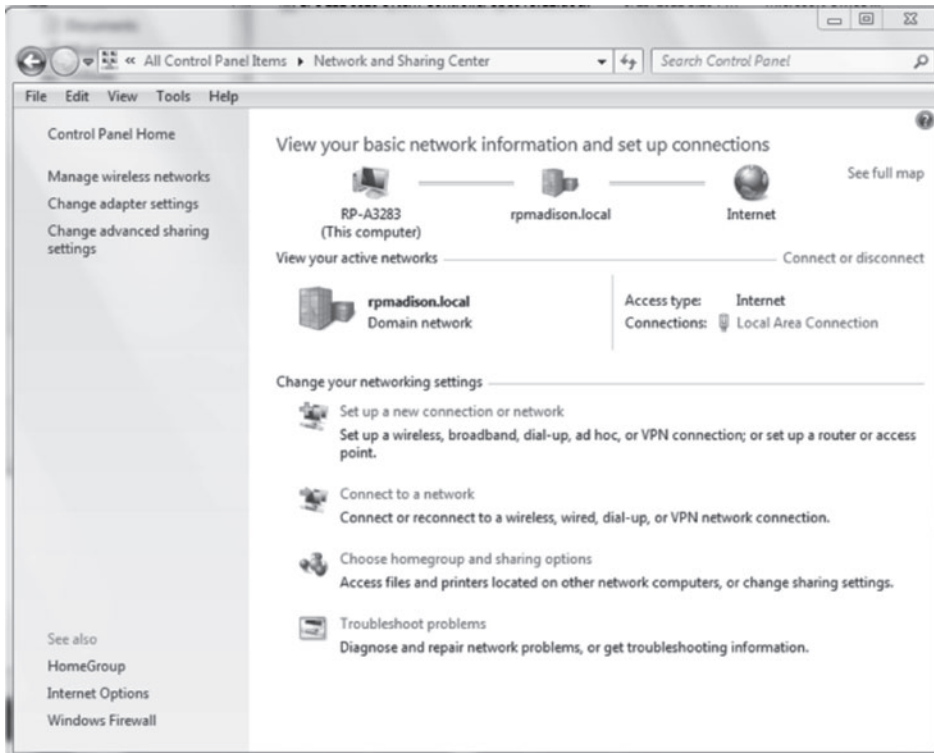

2. For Windows 7, select Internet Protocol Version 4 (TCP/IPv4) or for Windows XP, select Internet Protocol (TCP/IP). Then click Properties to bring up the TCP/IP dialogs.
3. If the **Use the following IP address** field is selected, make a note of the current IP address and Subnet mask for future reference:
Current IP address: _____
Current Subnet mask: _____
4. If **Obtain an IP address automatically** is selected instead, then click **Use the following IP address**.
5. Set the IP address to a unique IP address, such as 192.168.0.99, and set the Subnet mask to 255.255.255.0 as shown in the image at the right and click OK. On some computers you may have to restart the computer for your changes to take affect.

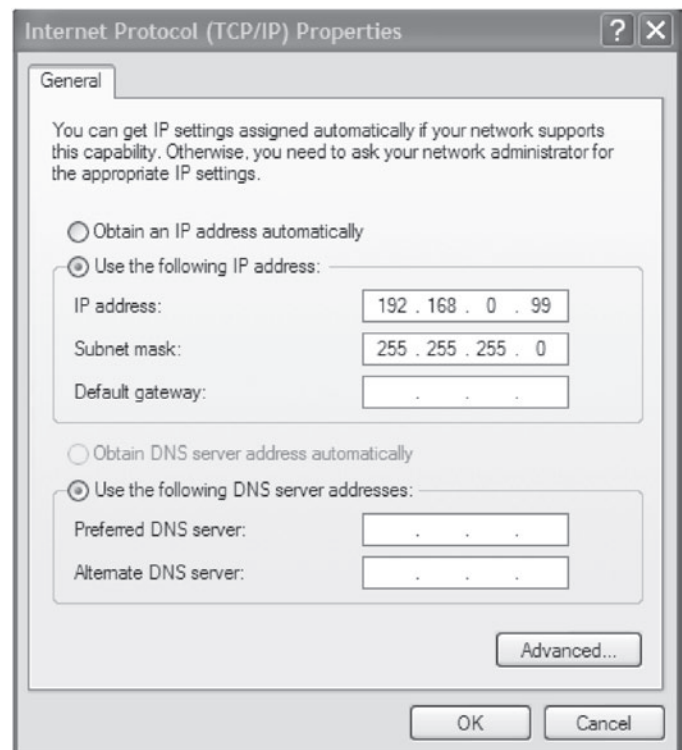

CHANGE YOUR IP ADDRESS ON YOUR SYSTEM CONTROLLER TO MATCH YOUR NETWORK SETTINGS

The following section describes how to change the IP address of the system controller. Perform these steps:

- If you have followed the previous steps to change your computer's IP address so that it starts with 192.168.0, and you are now ready to set the correct IP address for the System Controller, or
- If your computer's IP address does start with 192.168.0, but you want the IP address of the System Controller to be something other than 192.168.0.100.

1. Start a web browser on your computer.
2. Place the cursor in the address field and type `http://192.168.0.100` and then press Enter to bring up the page shown at right.



Aprilaire
Fresh Ideas for Indoor Air

RTA Alpha of **Aprilaire System Controller**

Navigation: About | Options | HVAC | Thermostats/Humidistats | **Network** | Admin

System Controller Model 8826

System Information:

About	
Software Version	00.01.13
Software Build Date	Sep 15 2011, 17:46:39
Log in to change Settings	
Login Name: <input type="text"/>	Password: <input type="password"/> <input type="button" value="Login"/>

Footer: Friday 7 January 2011 12:23 PM Alarms Exist Outside Temperature: 73°F

3. Select the Network tab at the top of the page. You will see the page at right:
4. Type in the desired IP address and Subnet mask to match your network.
5. Record the IP address that you entered below for future reference.

_____ . _____ . _____ . _____



Navigation: About | Options | HVAC | Thermostats/Humidistats | **Network** | Admin

Addressing

MAC Address	00:18:c7:01:02:03	
IP Address Method	Static	
IP Address	<input type="text" value="192.168.0.100"/>	<input type="text"/>
Subnet Mask	<input type="text" value="255.255.255.0"/>	<input type="text"/>
Gateway	<input type="text" value="192.168.0.1"/>	<input type="text"/>

Firewall

Inbound Port	<input type="text" value="80"/>	<input type="text"/>
--------------	---------------------------------	----------------------

Footer: Friday 7 January 2011 12:28 PM Alarms Exist Outside Temperature: 73°F

TO RESTORE YOUR COMPUTER'S IP ADDRESS

If you changed your computer's IP address to connect to the System Controller, follow these steps to restore your computer's IP address back to its original setting.

FOR WINDOWS XP

1a. Start the Control Panel by clicking Start, then Settings and Control Panel. In the Control Panel, locate and double click Network Connections to bring up Network Connections dialog, shown below. Select Local Area connection and then go to File and select Properties to bring up the Local Area Connection dialog box on the right, below.

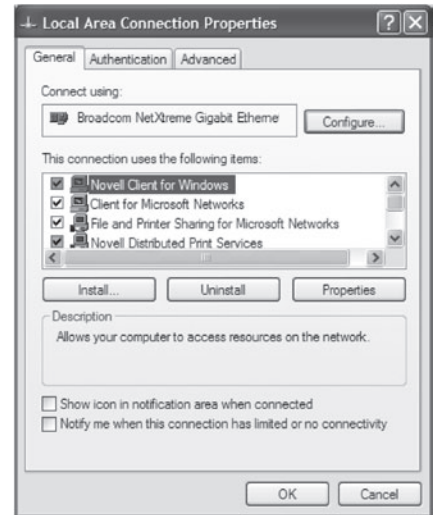
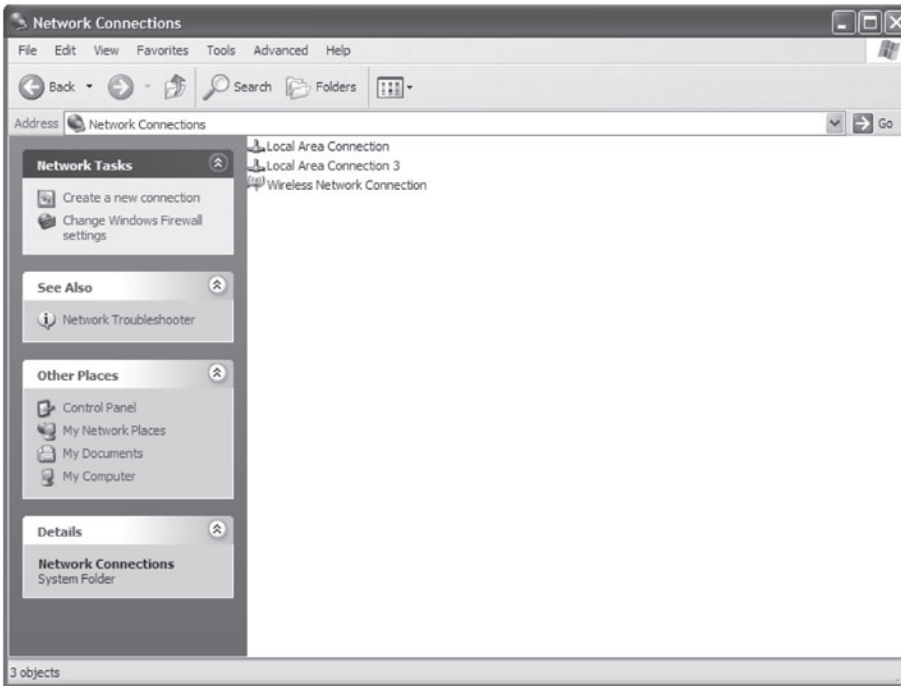

FOR WINDOWS 7

- 1b. Start the Control Panel by clicking Start, then Control Panel. In the Control Panel, locate and double click Network and Sharing Center to bring up Network and Sharing dialog, shown below. Double click on Local Area connection and then select Properties to bring up the Local Area Connection dialog box on the right, below.

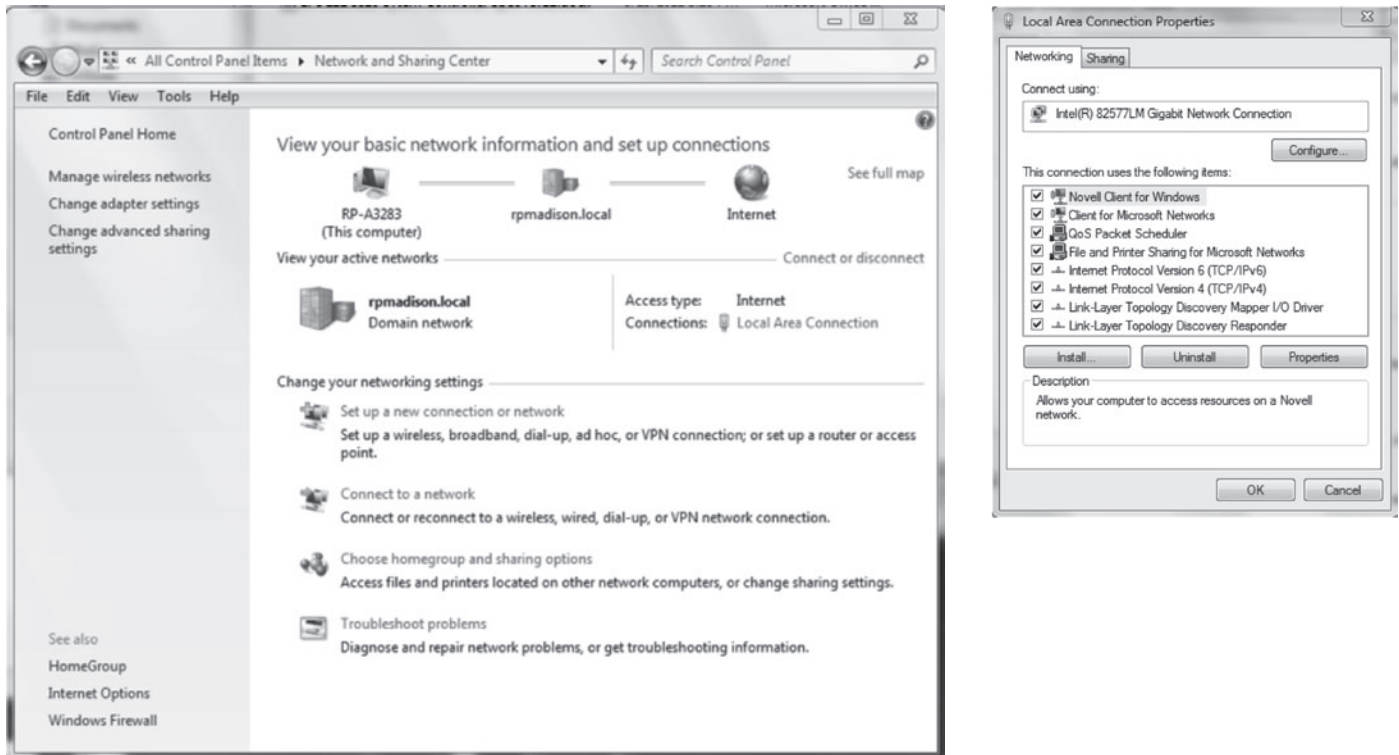

2. For Windows 7, select Internet Protocol Version 4 (TCP/IPv4) or for Windows XP, select Internet Protocol (TCP/IP). Then click Properties to bring up the TCP/IP dialogs.
3. If you wrote down an IP address during step 3 of Changing Your IP Address, Change the IP address and subnet mask to the previous values that you recorded. Otherwise, select Obtain an IP address automatically.
4. Click OK. On some computers you may have to restart the computer for your changes to take effect.

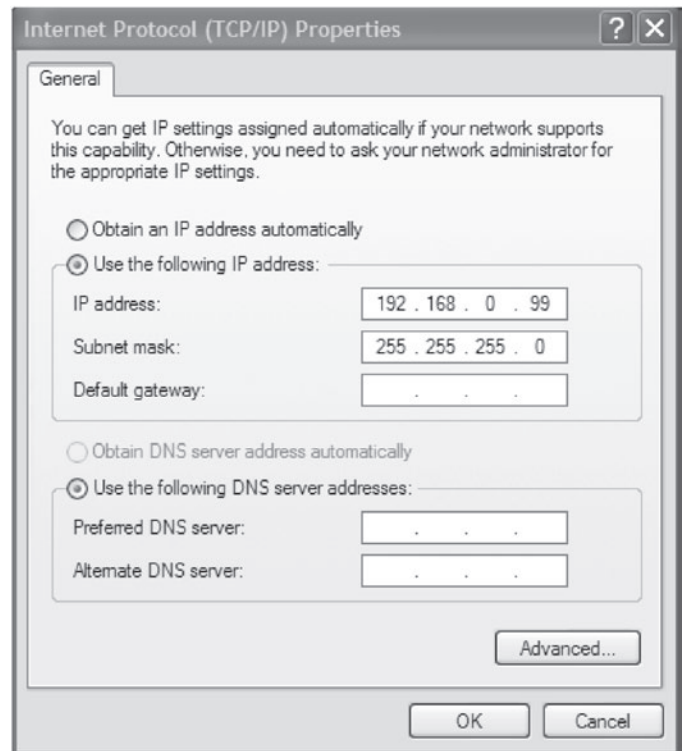

SYSTEM SET-UP

The screenshot shows the HVAC Configuration web interface. At the top, there are tabs for 'About', 'Options', 'HVAC', 'Thermostats/Humidistats', 'Network', and 'Admin'. The 'Options' tab is selected. The interface is organized into sections: 'Status' (Display Format, Service Override Time), 'Thermostat Settings' (Number of Thermostats and Humidistats, Email On Communication Loss/Restore, Email On Power Restore), 'Email Settings For Alarm Notification' (Email Account Username, Email Password, Time Zone, Primary/Secondary/Tertiary Email Contact), 'System' (Email Server Name, Primary/Secondary DNS IP Address, Identification, System Clock), and 'Master Scheduling'. A status bar at the bottom shows 'Thursday 17 November 2011 01:32 PM' and 'Alarms Exist'. A hand icon points to the 'Options' tab, and another points to the 'System' category in the left sidebar.

TEMPERATURE FORMAT

The Temperature Format field can be used to select between Fahrenheit and Celsius display. This setting will affect the temperature display on both the System Controller and the thermostats on the network.

SERVICE OVERRIDE

The Service Override feature can be used to activate the network override feature in the Model 8870 thermostats and Model 8800 thermostats that are set to non-programmable mode. When the network override feature is enabled the thermostat will ignore commands from the System Controller that modify the Mode, Fan or Setpoint settings. This feature can be used if maintenance is being performed on the network.

TIME AND DATE

The System Controller can be set to display the time in either a 12 hour or 24 hour format using the Time Format Selection.

The time is set by using the Set Time button. When the Set Time button is pressed the System Controller will update the time and date to match the web browser. The Time and Date of the System Controller will be written out to all the thermostats on the network.

NUMBER OF THERMOSTATS ON THE NETWORK

The number of thermostats on the network can be set either by manually setting the Number of Thermostats and Humidistats field or by using the Find button. When the Find button is pressed, the System Controller will automatically discover the number of thermostats on the network and populate the Number of Thermostats and Humidistats field. If the Find button is used to populate this field, confirm that the number of thermostats and humidistats on the network is correct. If the number is not populated correctly, the network settings at the thermostats should be verified.

NAMING THE SYSTEM CONTROLLER

The description of System Controller is displayed on the top of every page. The description can be changed using the Unit Description field. The unit description can be up to 26 characters and any combination of letters, numbers, spaces, and symbols. This name will also be used to identify the System Controller when e-mail alerts are sent.

SYSTEM STATUS BAR

The System Status Bar will be present for all pages on the System Controller. The System Status Bar will display the date and time. The System Status Bar will display "Alarms Exist" if there are any active alarms. The System Status bar will display the Outdoor temperature if there is an outdoor temperature sensor connected and enabled on the thermostat at Node Address 1.

ADDING HVAC AND HUMIDITY CONTROL EQUIPMENT

The HVAC page allows the user to set-up, up to 24 HVAC units. These units can be renamed for ease of identification. The Name field can be up to 12 characters and any combination of letters, numbers, spaces, and symbols.

The Controls Heat/Humid field is used to select if the equipment controls Heating, in the case of a thermostat or Humidification in the case of a humidistat.

The Controls Cool/Dhmd field is used to select if the equipment controls Cooling, in the case of a thermostat or Dehumidification in the case of a humidistat.

The Fan field is used to select if the thermostat controls the fan.

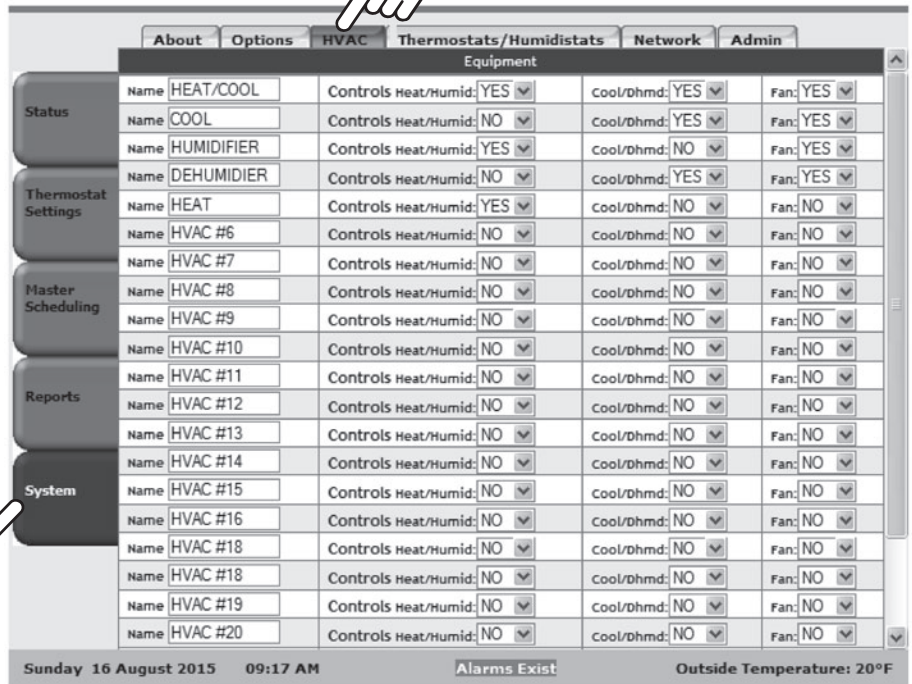

Equipment			
Name	HEAT/COOL	Controls Heat/Humid: YES	Cool/Dhmd: YES
Name	COOL	Controls Heat/Humid: NO	Cool/Dhmd: YES
Name	HUMIDIFIER	Controls Heat/Humid: YES	Cool/Dhmd: NO
Name	DEHUMIDIER	Controls Heat/Humid: NO	Cool/Dhmd: YES
Name	HEAT	Controls Heat/Humid: YES	Cool/Dhmd: NO
Name	HVAC #6	Controls Heat/Humid: NO	Cool/Dhmd: NO
Name	HVAC #7	Controls Heat/Humid: NO	Cool/Dhmd: NO
Name	HVAC #8	Controls Heat/Humid: NO	Cool/Dhmd: NO
Name	HVAC #9	Controls Heat/Humid: NO	Cool/Dhmd: NO
Name	HVAC #10	Controls Heat/Humid: NO	Cool/Dhmd: NO
Name	HVAC #11	Controls Heat/Humid: NO	Cool/Dhmd: NO
Name	HVAC #12	Controls Heat/Humid: NO	Cool/Dhmd: NO
Name	HVAC #13	Controls Heat/Humid: NO	Cool/Dhmd: NO
Name	HVAC #14	Controls Heat/Humid: NO	Cool/Dhmd: NO
Name	HVAC #15	Controls Heat/Humid: NO	Cool/Dhmd: NO
Name	HVAC #16	Controls Heat/Humid: NO	Cool/Dhmd: NO
Name	HVAC #18	Controls Heat/Humid: NO	Cool/Dhmd: NO
Name	HVAC #18	Controls Heat/Humid: NO	Cool/Dhmd: NO
Name	HVAC #19	Controls Heat/Humid: NO	Cool/Dhmd: NO
Name	HVAC #20	Controls Heat/Humid: NO	Cool/Dhmd: NO

Sunday 16 August 2015 09:17 AM Alarms Exist Outside Temperature: 20°F

CONFIGURING THERMOSTATS AND HUMIDISTATS

The Thermostat/Humidistats page is used to configure the thermostats and humidistats on the network. The Address Field is used to identify which thermostat or humidistat on the network is being displayed for set-up. The Model field will indicate what model thermostat is connected at that network address. The Prior and Next buttons can be used to navigate to the previous or next network address.

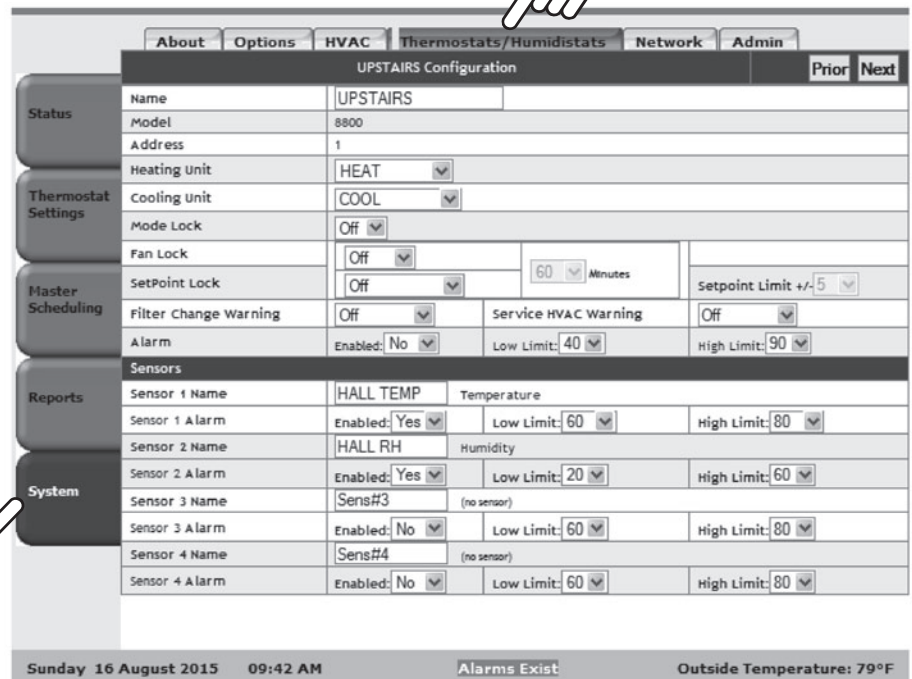

UPSTAIRS Configuration			
Name	UPSTAIRS		
Model	8800		
Address	1		
Heating Unit	HEAT		
Cooling Unit	COOL		
Mode Lock	Off		
Fan Lock	Off	60	Minutes
SetPoint Lock	Off	Setpoint Limit +/- 5	
Filter Change Warning	Off	Service HVAC Warning	Off
Alarm	Enabled: No	Low Limit: 40	High Limit: 90
Sensors			
Sensor 1 Name	HALL TEMP	Temperature	
Sensor 1 Alarm	Enabled: Yes	Low Limit: 60	High Limit: 80
Sensor 2 Name	HALL RH	Humidity	
Sensor 2 Alarm	Enabled: Yes	Low Limit: 20	High Limit: 60
Sensor 3 Name	Sens#3	(no sensor)	
Sensor 3 Alarm	Enabled: No	Low Limit: 60	High Limit: 80
Sensor 4 Name	Sens#4	(no sensor)	
Sensor 4 Alarm	Enabled: No	Low Limit: 60	High Limit: 80

Sunday 16 August 2015 09:42 AM Alarms Exist Outside Temperature: 79°F

NAMING THE THERMOSTATS/HUMIDISTATS

The Name field is used to identify the thermostat or humidistat on the rest of the System Controller pages. The Name field can be up to 20 characters and any combination of letters, numbers and spaces. The Name field does not allow symbols. If the thermostat being configured is a Model 8800, the thermostat name will be displayed in the message center on the thermostat.

ASSIGNING HEATING AND COOLING EQUIPMENT (THERMOSTAT ONLY)

The Heating Unit field is used to assign a heating unit to the thermostat. Only HVAC units where the Controls Heat/Humid field was set to Yes will be displayed as options for this field. If no heating unit is assigned the thermostat mode cannot later be set to Heat, Emergency Heat, or Auto.

The Cooling Unit field is used to assign a cooling unit to the thermostat. Only HVAC units where the Controls Cool/Dhmd field was set to Yes will be displayed as options for this field. If no cooling unit is assigned the thermostat mode cannot later be set to Cool or Auto.

LOCKOUTS

The Mode Lock field can be set to Full or Off. If the Mode Lock Field is set to Full, changes to the Mode setting will not be allowed to be made at the thermostat. If the Mode Lock field is set to Off, changes to the Mode setting will be allowed to be made at the thermostat.

The Fan Lock field (thermostat only), can be set to Full, Timed, or Off. If the Fan Lock field is set to Full, changes to the fan setting will not be allowed to be made at the thermostat. If the Fan Lock field is set to Timed, changes to the Fan setting are allowed at the thermostat, but will revert back to the previous setting after the time set by the Minutes field. If the Fan Lock field is set to Off, changes to the Fan setting will be allowed to be made at the thermostat.

The Setpoint Lock field can be set to Full, Timed, Timed Range, Range, or Off. If the Setpoint Lock field is set to Full, no changes to the setpoint are allowed at the thermostat. If the Setpoint Lock field is set to Timed Range, or Range, changes to the setpoint at the thermostat are limited by the Setpoint Limit field. If the Setpoint Lock field is set to Timed or Timed Range, changes to the setpoints are allowed at the thermostat, but will revert back to the previous setting after the time set by the Minutes field. If the Setpoint Lock field is set to Off, changes to the setpoints will be allowed at the thermostat.

SERVICE REMINDERS (MODEL 8800 THERMOSTATS ONLY)

For Thermostats the Filter Change Reminder and Service HVAC Reminder can be used to set the service reminders for the Model 8800 thermostat.

For Humidistats the Water Panel Change Reminder and Service Dehumidifier Reminder can be used to set the service reminders for the Model 8800 thermostat.

SENSORS

The System Controller can be used to monitor the status of up to 4 humidity or temperature sensors per thermostat. Sensors are implemented on the Model 8800 thermostat by installing the Aprilaire Model 8081 TT or Model 8082 TrH Support Module. Sensors are implemented on the Model 8870 thermostat by installing the Aprilaire Model 8061 TT or Model 8062 TrH Support Module. The first sensor is for Support Module address 1, sensor 1. The second sensor is for Support Module address 1, sensor 2. The third sensor is for Support Module address 2, sensor 1, and the fourth sensor is for Support Module address 2, sensor 2. If a sensor is installed at these locations the sensor type will be displayed. If no sensor is installed, a no sensor message will be displayed. If a sensor is attached to the thermostat, but does not appear on this page the support module dip switch settings should be verified.

Each sensor can be named so it can be more easily identified on other System Controller pages. The Sensor Name field can be up to 12 characters and any combination of letters, numbers, spaces, and symbols.

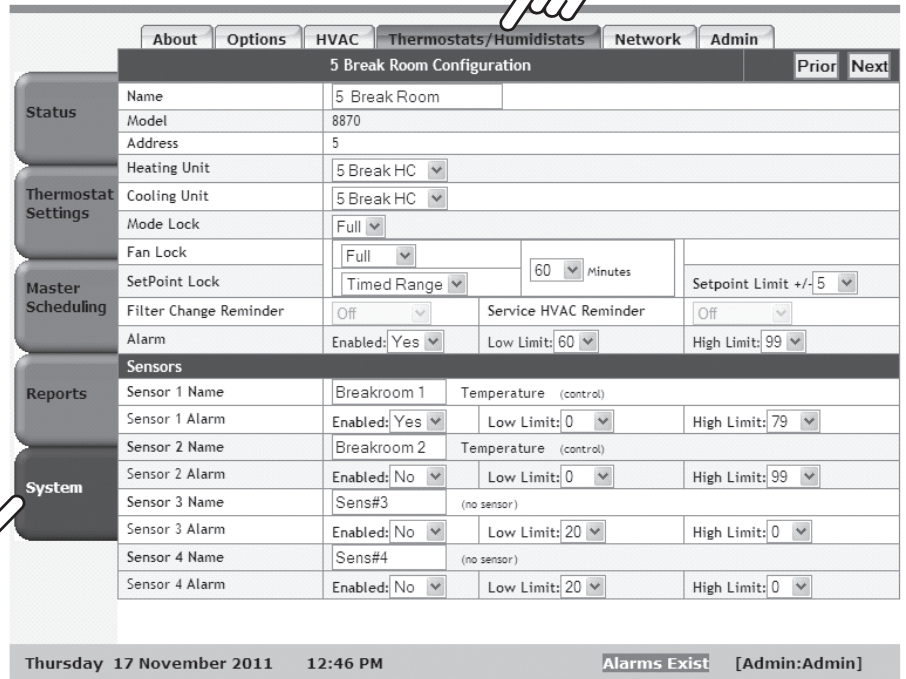

5 Break Room Configuration						Prior	Next
Status	Name	5 Break Room					
	Model	8870					
	Address	5					
Thermostat Settings	Heating Unit	5 Break HC					
	Cooling Unit	5 Break HC					
	Mode Lock	Full					
Master Scheduling	Fan Lock	Full		60	Minutes		
	SetPoint Lock	Timed Range				Setpoint Limit +/-5	
	Filter Change Reminder	Off				Service HVAC Reminder	Off
Reports	Alarm	Enabled: Yes		Low Limit: 60		High Limit: 99	
	Sensors						
	Sensor 1 Name	Breakroom 1		Temperature	(control)		
	Sensor 1 Alarm	Enabled: Yes		Low Limit: 0		High Limit: 79	
Sensor 2 Name	Breakroom 2		Temperature	(control)			
Sensor 2 Alarm	Enabled: No		Low Limit: 0		High Limit: 99		
Sensor 3 Name	Sens#3		(no sensor)				
Sensor 3 Alarm	Enabled: No		Low Limit: 20		High Limit: 0		
Sensor 4 Name	Sens#4		(no sensor)				
Sensor 4 Alarm	Enabled: No		Low Limit: 20		High Limit: 0		

Thursday 17 November 2011 12:46 PM Alarms Exist [Admin:Admin]

SECURITY

The 8826 comes by default with security disabled. When no security is enabled anyone who accesses the 8826 controller can edit any field.

Note: Once an Administrator log-in is created, the Administrator must log in to create the User name and password.

Security can be enabled by setting up a user name and password for both a User and an Administrator. The User and Administrator log-ins can be created on the Admin page. Once a user is logged in they can also use this page to logout using the Logout button.

Friday 7 January 2011 12:27 PM Alarms Exist Outside Temperature: 73°F

Once security is enabled, all pages can be viewed, but the user cannot modify anything until they log in using the About page.

Friday 7 January 2011 12:23 PM Alarms Exist Outside Temperature: 73°F

HUMIDISTAT SET-UP

Humidistats are controlled using the Humidistats page. The Prior and Next buttons are used to navigate through all the humidistats on the network.

The Humidity field displays the controlling humidity value for the humidistat.

Equipment Mode can be used to select between Off, Humidify, Dehumidify or Auto. In Auto mode the humidistat will control humidity through both humidification and dehumidification.

The Equipment Status will indicate if the equipment is off, humidifying or dehumidifying.

The Humidifier Set Point field is used to set the humidifier control set point.

The Dehumidifier Set Point field is used to set the dehumidifier control set point.

The screenshot shows the 'Humidistats' page for 'Basment Settings'. A hand icon points to the 'Humidistats' tab. The page has a sidebar with buttons for 'Status', 'Thermostat Settings', 'Master Scheduling', 'Reports', and 'System'. The main content area displays the following data:

Basment Settings		Prior	Next
Status	Humidity	45 %	
	Equipment Mode	Auto	
	Equipment Status	OFF	
	Humidifier Set Point	30 %	
	Dehumidifier Set Point	61 %	
	Change Water Panel	disabled	Reset
	Service Dehumidifier	disabled	Reset

At the bottom of the page, it displays: Monday 19 September 2011 12:51 PM Alarms Exist Outside Temperature: 82°F

THERMOSTAT SET-UP

Thermostats are controlled using the Thermostats page. The Prior and Next buttons are used to navigate through all the thermostats on the network.

The Temperature field displays the controlling temperature value for the thermostat.

The HVAC Mode field is used to control the HVAC mode of operation. The options are Off, Cool, Heat, Auto, and Em Ht. In Auto mode the thermostat will control both heating and cooling. In Em Ht the thermostat will control heating with Auxiliary Heat only. Note: options may be limited based on equipment type. The HVAC status will indicate if the equipment is heating, cooling or off.

The Fan Mode field is used to control the Fan mode of operation. The options are Auto, On and Circ. Note that Circ operates similarly to Auto, but guarantees 20 minutes of fan run time every hour. The Fan Status field indicates whether the fan is on or off.

The screenshot shows the 'Thermostats' page for 'Basment Settings'. A hand icon points to the 'Thermostats' tab. The page has a sidebar with buttons for 'Status', 'Thermostat Settings', 'Master Scheduling', 'Reports', and 'System'. The main content area displays the following data:

Basment Settings		Prior	Next
Status	Temperature	78 °F	
	HVAC Mode	Cool	
	HVAC Status	COOL	
	Fan Mode	Auto	
	Fan Status	OFF	
	Hold Mode	Temporary	
	Hold Setting	Heating 85 °F	Cooling 95 °F
	End Time	3:30AM	
	Resume Schedule	Resume Schedule	
	Change Filter	OK	Reset
	Service HVAC	OK	Reset
	Schedule Settings		
	Type	Individual	
	Heat	62 °F	
	Cool	82 °F	

At the bottom of the page, it displays: Monday 19 September 2011 12:39 PM Alarms Exist Outside Temperature: 81°F

SCHEDULING

MASTER SCHEDULES

The System Controller has four Master Schedules. The Prior and Next buttons are used to move between the four Master Schedules. The Master Schedules can be named using the Master Schedule field at the top of the page. The Events per Day field is used to select between 2 and 4 events per day. When configured for 4 events per day the events are Wake, Leave, Return, and Sleep. When configured for 2 events per day the events are Occupied and Unoccupied. Each event has a Start Time, Heat Setpoint, Cool Setpoint and Fan Mode. The Cool Setpoint can be no lower than the Heat Setpoint plus the deadband. Each day is configured by selecting the corresponding day button. All days that have identical settings are highlighted in yellow. The Hldy button is used to set a schedule for holidays. The Copy to Weekday, Copy to Previous Day and Copy to All buttons can be used to eliminate steps required to configure the schedule.

The screenshot shows the 'Master Schedules' interface. At the top, there are tabs for 'Master', 'Holiday', and 'Vacation'. Below them, 'Master Schedule #1' is selected, and 'Events per Day' is set to 4. The main area is titled 'Wednesday' and contains four event columns: 'Wake', 'Leave', 'Return', and 'Sleep'. Each event has a 'Start' time, 'Heat' and 'Cool' setpoints, and a 'Fan' mode. The 'Wake' event starts at 6:00AM with Heat at 70 and Cool at 78. The 'Leave' event starts at 8:00AM with Heat at 62 and Cool at 85. The 'Return' event starts at 5:00PM with Heat at 70 and Cool at 78. The 'Sleep' event starts at 10:00PM with Heat at 62 and Cool at 82. All fan modes are set to 'AUTO'. Below the events are buttons for 'Copy to Weekday', 'Copy Previous Day', and 'Copy to All'. At the bottom, there are day selection buttons (Mon, Tue, Wed, Thu, Fri, Sat, Sun, Hldy) and a status bar showing 'Monday 19 September 2011 12:43 PM', 'Alarms Exist', and 'Outside Temperature: 81°F'. Hand icons point to the 'Master' tab and the 'Master Scheduling' menu item.

The Schedules page is used to control thermostat schedules. The thermostat description is displayed on the top of the page. The Prior and Next Buttons are used to navigate between thermostats on the network. The Events per Day field is used to select between 2 and 4 events per day. When configured for 4 events per day the events are Wake, Leave, Return, and Sleep. When configured for 2 events per day the events are Occupied and Unoccupied. Each event has a Start Time, Heat Setpoint, Cool Setpoint and Fan Mode. The Cool Setpoint can be no lower than the Heat Setpoint plus the deadband. Each day is configured by selecting the corresponding day button. All days that have identical settings are highlighted in yellow. The Hldy button is used to set a schedule for holidays. The Copy to Weekday, Copy to Previous Day and Copy to All buttons can be used to eliminate steps required to configure the schedule. The Active Schedule can be changed from the individual thermostat schedule to a master schedule using the Active Schedule field.

The screenshot shows the 'Schedules' interface. At the top, there are tabs for 'Thermostats', 'Humidistats', and 'Schedules'. Below them, 'Basement Schedule' is selected, and 'Events per Day' is set to 4. The main area is titled 'Wednesday' and contains four event columns: 'Wake', 'Leave', 'Return', and 'Sleep'. Each event has a 'Start' time, 'Heat' and 'Cool' setpoints, and a 'Fan' mode. The 'Wake' event starts at 3:15AM with Heat at 70 and Cool at 78. The 'Leave' event starts at 3:30AM with Heat at 62 and Cool at 85. The 'Return' event starts at 8:30AM with Heat at 70 and Cool at 78. The 'Sleep' event starts at 10:30AM with Heat at 62 and Cool at 82. All fan modes are set to 'AUTO'. Below the events are buttons for 'Copy to Weekday', 'Copy Previous Day', and 'Copy to All'. To the right, there is an 'Active Schedule:' field with a dropdown menu set to 'Individual' and a 'Save As Individual' button. At the bottom, there are day selection buttons (Mon, Tue, Wed, Thu, Fri, Sat, Sun, Hldy) and a status bar showing 'Monday 19 September 2011 12:42 PM', 'Alarms Exist', and 'Outside Temperature: 81°F'. Hand icons point to the 'Schedules' tab and the 'Thermostat Settings' menu item.

HOLIDAYS

The Holiday page is used to designate a date as a holiday. When a date is set as a holiday all thermostats will run the holiday schedule instead of the schedule for that day of the week. The Restore US Holidays button can be used to restore the default US Holidays. US Holidays and the ten user holidays can be edited using the Edit Holiday or Daylight Savings button.

If e-mail is set-up, the System Controller will send a reminder on January 1st to update the holidays for the new year. If holidays are not updated, the holidays from the previous year will be used.

	#	Holiday	Month	Day
Status	1	New Year's Day	January	1
	2	Martin Luther King Day	January	17
	3	President's Day	February	21
Thermostat Settings	4	Memorial Day	May	30
	5	Independence Day	July	4
	6	Labor Day	September	5
	7	Veterans Day	November	11
Master Scheduling	8	Thanksgiving Day	November	24
	9	Christmas Day	December	25
	10	UserHoliday	---	---
Reports	11	UserHoliday	---	---
	12	UserHoliday	---	---
	13	UserHoliday	---	---
	14	UserHoliday	---	---
	15	UserHoliday	---	---
	16	UserHoliday	---	---
System	17	UserHoliday	---	---
	18	UserHoliday	---	---
	19	UserHoliday	---	---
	20	UserHoliday	---	---

In the Edit Holiday or Daylight Savings Screen the name of holiday being edited appears in the Name field, and this field can be modified to change the name of the holiday. The holiday to be edited can be selected using the holiday selection field. The date field is used to assign a date to the holiday. When a date is assigned, the holiday is added as an active holiday. Holidays can be deleted using the Delete button.

The Daylight Savings Time Start and Daylight Savings Time End fields are used to set the beginning and end of daylight savings. The Delete button is used to disable daylight savings. The Restore button is used to re-enable daylight savings and restore the default daylight savings start and end dates.

The Done button is used to return to the main Holiday page.

HOLDS

The Vacation page can be used to suspend the schedule at all thermostats with a single action. The Heating and Cooling fields are used to set the temperature set points. The Fan Mode field is used to set the fan mode during vacation hold. The End Date and End Time fields set the time at which the vacation hold will end and the thermostats will resume their schedules. An active vacation hold can be ended prior to the end date and time with the Resume Schedule button.

The screenshot shows the 'Vacation' configuration page. At the top, there are tabs for 'Master', 'Holiday', and 'Vacation'. The 'Vacation' tab is active. Below the tabs, there are several fields: 'Vacation Hold Setting' (OFF), 'Heating' (54°F), 'Cooling' (85°F), 'Fan Mode' (On), 'End Date' (09/19/2011), and 'End Time' (1:00PM). A 'Resume Schedule' button is located on the right side of the form. The left sidebar contains buttons for 'Status', 'Thermostat Settings', 'Master Scheduling', 'Reports', and 'System'. At the bottom, there is a status bar showing 'Monday 19 September 2011 12:46 PM', 'Alarms Exist', and 'Outside Temperature: 81°F'.

INDIVIDUAL HOLDS

Holds can be created for individual thermostats with the Hold Mode field on the Thermostats page. Use the Prior and Next buttons to navigate to the thermostat where the hold will be created. The Hold Mode can be set to temporary or permanent.

In Permanent Hold, the Heating and Cooling fields are used to set the heating and cooling set points. The Hold will remain active until the Resume Schedule button is used to cancel the hold.

Setting a Permanent or Vacation Hold will cancel the Temporary Hold.

Setting a Temporary or Vacation Hold will cancel Permanent Hold.

In Temporary Hold, the Heating and Cooling fields are used to set the heating and cooling set points. The End Time field is used to set the time at which the Temporary Hold ends. The Hold can be cancelled prior to the end time using the Resume Schedule button.

The screenshot shows the 'Thermostats' page for 'Basment Settings'. At the top, there are tabs for 'Thermostats', 'Humidistats', and 'Schedules'. The 'Schedules' tab is active. Below the tabs, there are several fields: 'Temperature' (78°F), 'HVAC Mode' (Cool), 'HVAC Status' (COOL), 'Fan Mode' (Auto), 'Fan Status' (OFF), 'Hold Mode' (Temporary), 'Hold Setting' (Heating 85°F, Cooling 95°F), 'End Time' (3:30AM), and a 'Resume Schedule' button. The left sidebar contains buttons for 'Status', 'Thermostat Settings', 'Master Scheduling', 'Reports', and 'System'. At the bottom, there is a status bar showing 'Monday 19 September 2011 12:39 PM', 'Alarms Exist', and 'Outside Temperature: 81°F'.

STATUS

The Thermostats status page displays information for all of the thermostats in the system. The Heat and Cool columns show the current heat and cool set points, which come from either the current event of the schedule or a hold if there is an active hold. The Temp column shows the room temperature value for each thermostat. The Mode column indicates what mode of control the thermostat is set to. The Fan column indicates if the fan is active. The Schedule column indicates what schedule the thermostat is assigned to and the Program column indicates if the schedule is active or if there is an Active Hold at the thermostat. The Alarm column will indicate if there are any active alarms for the thermostat.



Thermostats		Humidistats		Sensors				
Name	Heat	Temp	Cool	Mode	Fan	Schedule	Program	Alarm
Room 1	62 °F	76 °F	99 °F	AUTO	Off	MS A 4 per day	Program Running	OK
Room 2	61 °F	78 °F	71 °F	AUTO	On	Individual	Program Running	OK
Room 4	62 °F	78 °F	72 °F	COOL	On	MS A 4 per day	Vacation Hold	OK

Wednesday 21 September 2011 12:15 PM Outside Temperature: 77°F

The Humidistats status page displays information for all of the thermostats in the system. The Humidification Setpoint and Dehumidification Setpoint columns show the current humidification and dehumidification set points. The Humidity column shows the controlling humidity value for each humidistat. The Mode column indicates what mode of control the humidistat is set to. The Alarm column will indicate if there are any active alarms for the humidistat.



Thermostats		Humidistats		Sensors	
Name	Humidification Setpoint	Humidity	Dehumidification Setpoint	Mode	Alarm
Room 3	48 %	44 %	55 %	AUTO	OK

Wednesday 21 September 2011 12:16 PM Outside Temperature: 77°F

The Sensors status page displays information for all the sensors in the system. The sensor can be identified by the sensor Name column which was assigned in the System tab, Thermostats/Humidistats page. The sensor can also be identified using a combination of the Connected to Humidistat/Thermostat column, which will identify the thermostat the sensor is connected to, and the Description column which will indicate the Support Module address and sensor number.

The Value column will display the value that the sensor is reading.

The Alarm column will indicate if the sensor value has generated an alarm.

Thermostats		Humidistats		Sensors	
Name	Value	Alarm	Connected to Humidistat/Thermostat		Description
Sens#3	77 °F	OK	Room 1		Module2 Sensor 1

Wednesday 21 September 2011 12:17 PM Outside Temperature: 77°F

SETTING ALARMS

Alarms can be configured for sensor values, the controlling temperature value for a thermostat and the controlling humidity value for a humidistat using the Thermostats/Humidistats page. Use the Prior and Next buttons to navigate to the thermostat or humidistat to be configured.

Each alarm can be individually enabled and have a high and low limit set. When an alarm is enabled and the value exceeds either the low or high limit an alarm will be generated.

The Alarms Exist message will be displayed on the System Status Bar until the alarm condition no longer exists. For example a sensor value returning to a value above the Low Limit and below the High Limit.

About		Options		HVAC		Thermostats/Humidistats		Network		Admin	
BASEMENT Configuration											
Name		BASEMENT									
Model		8800									
Address		2									
Humidify Unit		None									
Dehumidify unit		DEHUMIDIER									
Mode Lock		Off									
Fan Lock		Off		60		Minutes					
SetPoint Lock		Off						Setpoint Limit +/- 5			
Water Panel Change Warning		Off						Service Dehumidifier Warning Off			
Alarm		Enabled: No		Low Limit: 40				High Limit: 90			
Sensors											
Sensor 1 Name		Theatre Temp (no sensor)									
Sensor 1 Alarm		Enabled: No		Low Limit: 60				High Limit: 80			
Sensor 2 Name		Theatre RH (no sensor)									
Sensor 2 Alarm		Enabled: No		Low Limit: 20				High Limit: 60			
Sensor 3 Name		Sens#3 (no sensor)									
Sensor 3 Alarm		Enabled: No		Low Limit: 40				High Limit: 90			
Sensor 4 Name		Sens#4 (no sensor)									
Sensor 4 Alarm		Enabled: No		Low Limit: 40				High Limit: 90			

Sunday 16 August 2015 09:45 AM Alarms Exist Outside Temperature: 79°F

ALARMS

Alarms can be viewed using the Logging page.

On the Logging page, alarms can be viewed either by the most recent or from a selected date. The possible alarms are:

- Temperature/Humidity above limit
- Temperature/Humidity below limit
- Sensor above limit
- Sensor below limit
- Communication timeout
- Filter change
- Water panel change
- Service HVAC
- Service dehumidifier
- Power restored
- Communication lost/restored
- Vacation Hold ended
- Date not set
- Manufacturer initialization occurred
- EEPROM Failed (nonvolatile memory)

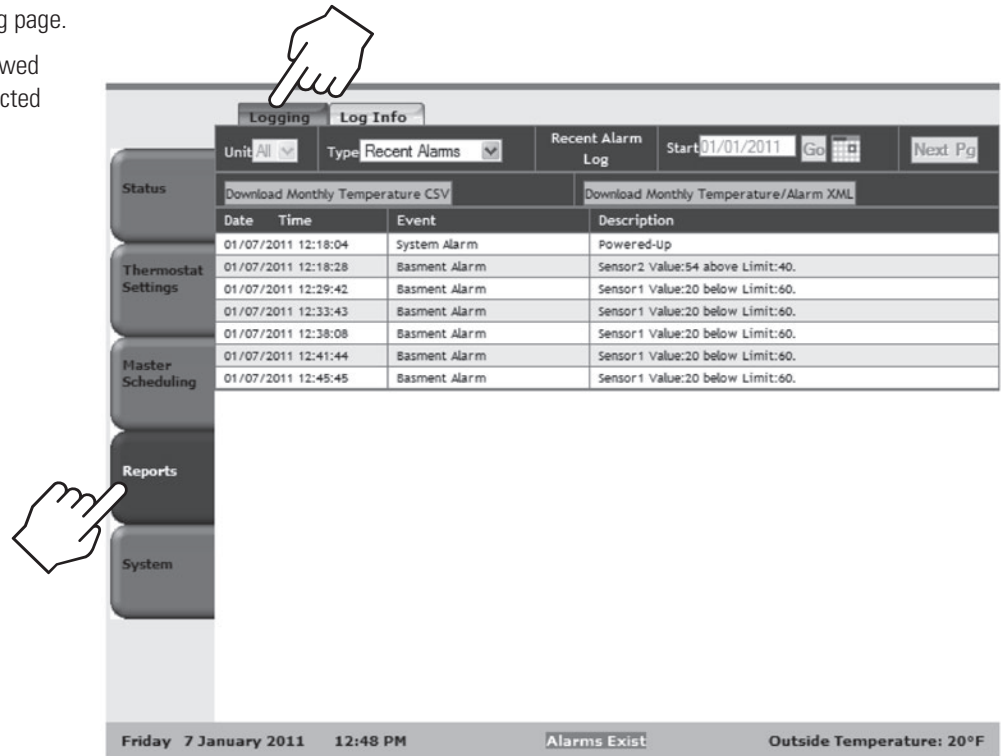

The screenshot shows the 'Logging' page with the 'Log Info' tab selected. The page displays a table of recent alarms with columns for Date, Time, Event, and Description. The status bar at the bottom indicates 'Friday 7 January 2011 12:48 PM', 'Alarms Exist', and 'Outside Temperature: 20°F'.

Date	Time	Event	Description
01/07/2011	12:18:04	System Alarm	Powered-Up
01/07/2011	12:18:28	Basment Alarm	Sensor2 Value:54 above Limit:40.
01/07/2011	12:29:42	Basment Alarm	Sensor1 Value:20 below Limit:60.
01/07/2011	12:33:43	Basment Alarm	Sensor1 Value:20 below Limit:60.
01/07/2011	12:38:08	Basment Alarm	Sensor1 Value:20 below Limit:60.
01/07/2011	12:41:44	Basment Alarm	Sensor1 Value:20 below Limit:60.
01/07/2011	12:45:45	Basment Alarm	Sensor1 Value:20 below Limit:60.

E-MAIL ALERTS

If e-mail is set-up on the options page, alarms will be e-mailed out as they occur.

To set up e-mail enter the Username and Password for the account that alerts will be sent from in the Email Account and Username fields. The Primary, Secondary and Tertiary Email contacts are the Email addresses of where the e-mail alerts will be sent. To determine the proper Email Server Name, Primary DNS IP Address, Secondary DNS IP Address and Port please consult an IT professional or your internet service provider.

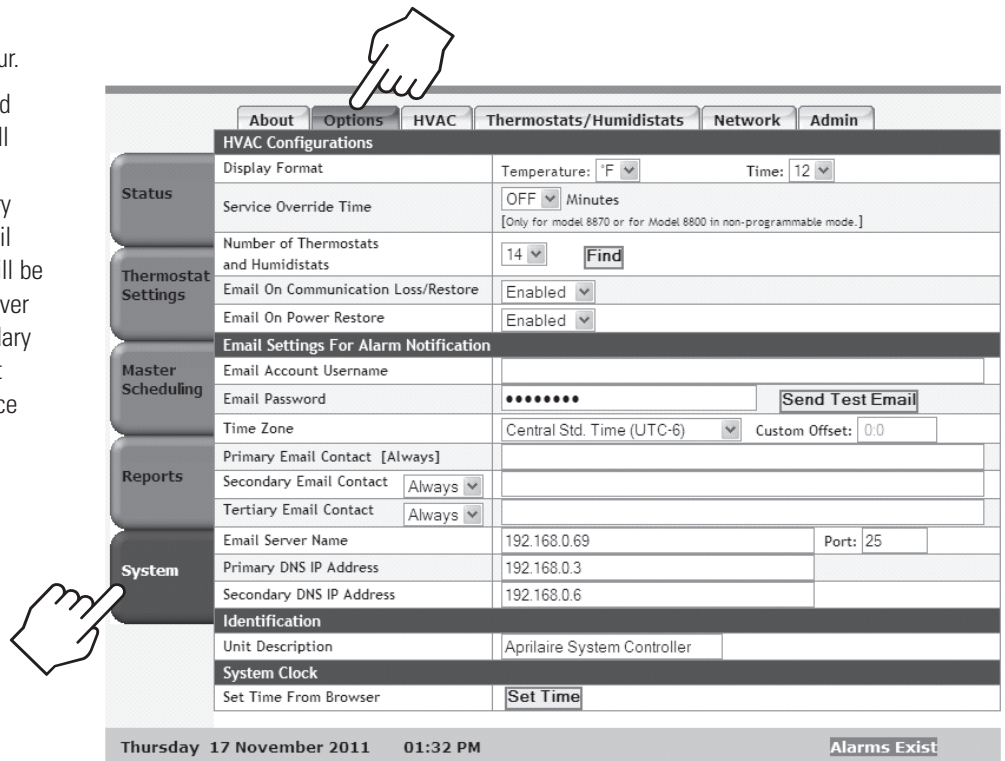

The screenshot shows the 'Options' page with the 'Options' tab selected. The page displays various settings for HVAC configurations, email alerts, and system identification. The status bar at the bottom indicates 'Thursday 17 November 2011 01:32 PM' and 'Alarms Exist'.

Category	Field	Value
Status	Display Format	Temperature: F, Time: 12
	Service Override Time	OFF Minutes
	Number of Thermostats and Humidistats	14
Thermostat Settings	Email On Communication Loss/Restore	Enabled
	Email On Power Restore	Enabled
Master Scheduling	Email Settings For Alarm Notification	
	Email Account Username	
	Email Password	••••••••
Reports	Primary Email Contact [Always]	
	Secondary Email Contact	Always
	Tertiary Email Contact	Always
System	Email Server Name	192.168.0.69 Port: 25
	Primary DNS IP Address	192.168.0.3
	Secondary DNS IP Address	192.168.0.6
Identification		
Unit Description		Aprilaire System Controller
System Clock		Set Time From Browser

SERVICE REMINDERS

For systems using Model 8800 thermostats, the System Controller can be used to manage service reminders. For Model 8800 thermostats configured as a thermostat the Filter Change Reminder field can be used to specify the time period for the Change Air Filter Reminder and the Service HVAC Reminder field can be used to specify a time period for the Service HVAC reminder.

2 North Entry Configuration Prior Next

Status	Name	2 North Entry			
	Model	8800			
	Address	2			
Thermostat Settings	Heating Unit	2 N Entry H			
	Cooling Unit	None			
	Mode Lock	Full			
Master Scheduling	Fan Lock	Full	60	minutes	
	SetPoint Lock	Full	Setpoint Limit +/- 5		
	Filter Change Reminder	Off	Service HVAC Reminder	Off	
Reports	Alarm	Enabled: No	Low Limit: 60	High Limit: 85	
	Sensors				
	Sensor 1 Name	Sens#1	(no sensor)		
	Sensor 1 Alarm	Enabled: No	Low Limit: 20	High Limit: 0	
	Sensor 2 Name	Sens#2	(no sensor)		
	Sensor 2 Alarm	Enabled: No	Low Limit: 20	High Limit: 0	
	Sensor 3 Name	Sens#3	(no sensor)		
	Sensor 3 Alarm	Enabled: No	Low Limit: 20	High Limit: 0	
System	Sensor 4 Name	Sens#4	(no sensor)		
	Sensor 4 Alarm	Enabled: No	Low Limit: 20	High Limit: 0	

Thursday 17 November 2011 01:36 PM Alarms Exist

The service reminder status can be Disabled, Active or Ok. The status is Disabled if the reminder is set to off. The status is OK if the reminder is enabled, but service is not required. The status is Active if service is required.

Active service reminders can be reset on the Thermostats page using the Reset buttons for the Change Filter and Service HVAC fields.

Basement Settings Prior Next

Status	Temperature	78 °F		
	HVAC Mode	Cool		
	HVAC Status	COOL		
Thermostat Settings	Fan Mode	Auto		
	Fan Status	OFF		
	Hold Mode	Temporary		
Master Scheduling	Hold Setting	Heating 85 °F	Cooling 95 °F	End Time 3:30AM
	Change Filter	OK	Reset	
	Service HVAC	OK	Reset	
Reports	Schedule Settings			
	Type	Individual		
	Heat	62 °F		
System	Cool	82 °F		

Monday 19 September 2011 12:39 PM Alarms Exist Outside Temperature: 81 °F

For Model 8800 thermostats configured as humidistats, the Water Panel Change Reminder field can be used to specify the time period for the Change Water Panel Reminder and one or two reminders per season. Drainless (DL) humidifiers will be set to two reminders per season and Flow Through (FT) humidifiers will be set to one reminder per season. The Service Dehumidifier Reminder field can be used to specify a time period for the Service Dehumidifier reminder.

BASEMENT Configuration Prior Next

Status	Name	BASEMENT			
	Model	8800			
	Address	2			
Thermostat Settings	Humidify Unit	None			
	Dehumidify Unit	DEHUMIDIER			
	Mode Lock	Off			
Master Scheduling	Fan Lock	Off	60 Minutes		
	SetPoint Lock	Off		Setpoint Limit +/- 5	
	Water Panel Change Warning	Off	Service Dehumidifier Warning	Off	
Reports	Alarm	Enabled: No	Low Limit: 40	High Limit: 90	
	Sensors				
	Sensor 1 Name	Theatre Temp (no sensor)			
	Sensor 1 Alarm	Enabled: No	Low Limit: 60	High Limit: 80	
	Sensor 2 Name	Theatre RH (no sensor)			
	Sensor 2 Alarm	Enabled: No	Low Limit: 20	High Limit: 60	
	Sensor 3 Name	Sens#3 (no sensor)			
	Sensor 3 Alarm	Enabled: No	Low Limit: 40	High Limit: 90	
Sensor 4 Name	Sens#4 (no sensor)				
Sensor 4 Alarm	Enabled: No	Low Limit: 40	High Limit: 90		

Sunday 16 August 2015 09:45 AM Alarms Exist Outside Temperature: 79°F

The service reminder status can be Disabled, Active or Ok. The status is Disabled if the reminder is set to off. The status is OK if the reminder is enabled, but service is not required. The status is Active if service is required.

Active service reminders can be reset on the Humidistats page using the Reset buttons for the Change Water Panel and Service Dehumidifier fields.

Basment Settings Prior Next

Status	Humidity	45 %	
	Equipment Mode	Auto	
	Equipment Status	OFF	
Thermostat Settings	Humidifier Set Point	30 %	
	Dehumidifier Set Point	61 %	
	Change Water Panel	disabled	Reset
	Service Dehumidifier	disabled	Reset

Monday 19 September 2011 12:51 PM Alarms Exist Outside Temperature: 82°F

FIRMWARE UPDATE

Aprilaire may periodically release updated firmware revisions for the System Controller. To update firmware on your System Controller go to www.aprilairepartners.com and download the latest version of firmware and the firmware update utility. Once you have downloaded the firmware update utility and the latest version of firmware, follow these steps to update the System Controller firmware.

1. Open the firmware update utility.
2. Select the Browse button and navigate to the firmware that you would like to load onto the System Controller.

Note: The IP address will be populated automatically when the update process begins.

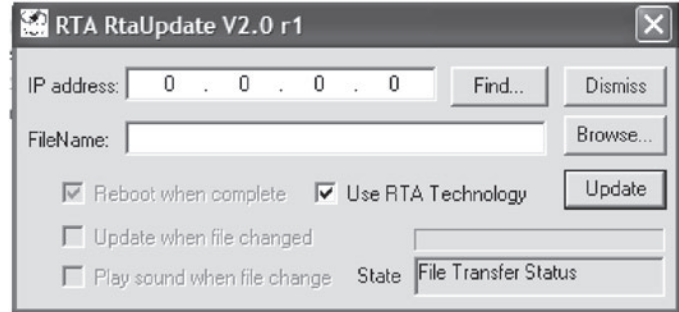

3. Go to the Admin page on the system controller and click on the Start button in the Start Download field.
4. Watch the status field in the firmware update utility to view the progress of the firmware update.
5. Once the firmware update is complete, cycle power to the System Controller.

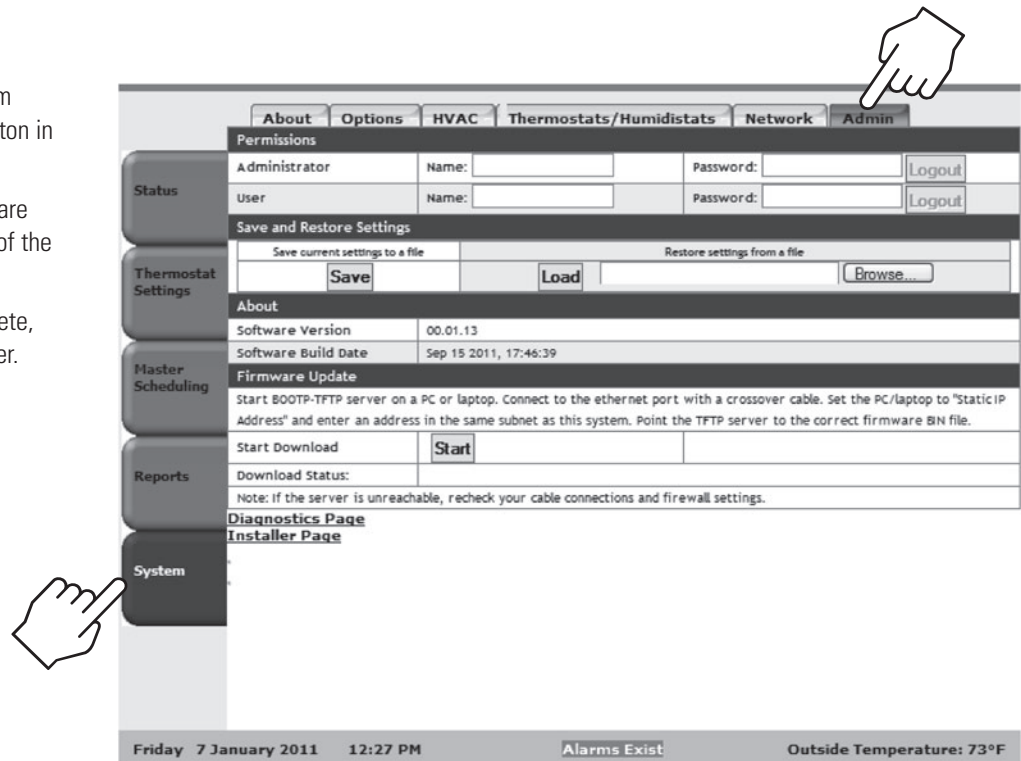

LED DIAGNOSTICS

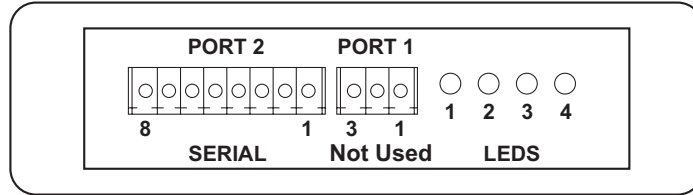

LED 1 (Module Status)	
Red Solid	Unrecoverable Fault
Red Flashing	Recoverable Fault
Green Solid	Normal Operation

LED 2 (Ethernet Status)	
Red Solid	Unrecoverable Fault
Green Flashing	Normal operation

LED 3 (Module Status)	
Red Solid	Thermostat Timeouts exist
Green Solid	Normal operation

LED 4 (Alarm Status)	
Red Flashing	Alarms exist
Green Solid	Normal Operation

LIMITED WARRANTY

Your Research Products Corporation Aprilaire® System Controller is expressly warranted for five (5) years from date of installation to be free from defects in materials and workmanship.

Research Products Corporation's exclusive obligation under this warranty shall be to supply, without charge, a replacement for any System Controller which is found to be defective within such five (5) year period and which is returned, together with the date of installation, no later than thirty (30) days after said five (5) year period by you to either your original supplier or to Research Products Corporation, Madison, Wisconsin, 53701.

THIS WARRANTY SHALL NOT OBLIGATE RESEARCH PRODUCTS CORPORATION FOR ANY LABOR COSTS AND SHALL NOT APPLY TO DEFECTS IN WORKMANSHIP OR MATERIALS FURNISHED BY YOUR INSTALLER AS CONTRASTED TO DEFECTS IN THE SYSTEM CONTROLLER ITSELF.

IMPLIED WARRANTIES OF MERCHANTABILITY OF FITNESS FOR A PARTICULAR PURPOSE SHALL BE LIMITED IN DURATION TO THE AFORESAID FIVE YEAR PERIOD. RESEARCH PRODUCTS CORPORATION LIABILITY FOR INCIDENTAL OR CONSEQUENTIAL DAMAGES, OTHER THAN DAMAGES FOR PERSONAL INJURIES, RESULTING FROM ANY BREACH OF THE AFORESAID IMPLIED WARRANTIES OR THE ABOVE LIMITED WARRANTY IS EXPRESSLY EXCLUDED. THIS LIMITED WARRANTY IS VOID IF DEFECT(S) RESULT FROM FAILURE TO HAVE THIS SYSTEM CONTROLLER INSTALLED BY A QUALIFIED HEATING AND AIR CONDITIONING CONTRACTOR. IF THE LIMITED WARRANTY IS VOID DUE TO FAILURE TO USE A QUALIFIED CONTRACTOR, ALL DISCLAIMERS OF IMPLIED WARRANTIES SHALL BE EFFECTIVE UPON INSTALLATION.

Some areas do not allow limitations on how long an implied warranty lasts or the exclusion or elimination of incidental or consequential damages so the above exclusion or limitation may not apply to you.

This warranty gives you specific legal rights and you may also have other rights which vary from state to state.

This equipment, if installed in strict accordance with the manufacturer's instructions, complies with the limits for a Class B computing device pursuant to Subpart J of Part 15 of FCC Rules.

WARRANTY REGISTRATION

Visit us on-line at www.aprilaire.com to register your Aprilaire product. If you do not have on-line access, please mail a postcard with your name, address, phone number, email address, product purchased, model number, date of purchase and dealer name and address to:

Research Products Corporation, P.O. Box 1467, Madison, WI 53701

Your Warranty Registration information will not be sold or shared outside of this company.

SYSTEM REQUIREMENTS

The 8826 system controller is designed to work with the following operating systems and web browsers. If you experience difficulties accessing or controlling it from your computer, please make sure it conforms to the following system requirements.

Supported Operating Systems:

Windows 7 (Service Pack 1)

Windows XP (Service Pack 3)

Supported Web Browsers:

Internet Explorer 8 or 9

Mozilla FireFox 9.0.1

Google Chrome 16

At its option, Aprilaire® may provide firmware updates to this product in order to provide additional compatibility with changes to the software listed above.



P.O. Box 1467 • Madison, WI 53701-1467 • Phone: 800/334-6011 • Fax: 608/257-4357 • www.aprilairepartners.com