

MODEL 374RAN OIL FURNACE

NOTE TO INSTALLER:

This manual must be left with the equipment user.

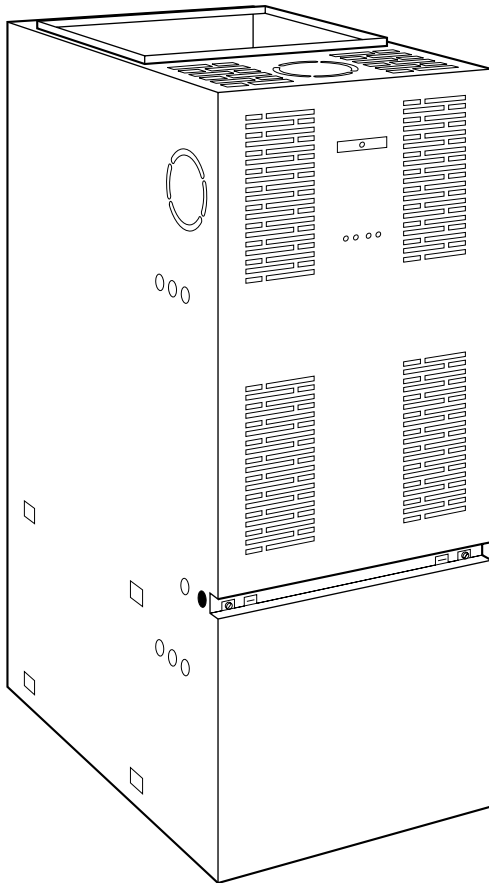

⚠ WARNING: If the information in this manual is not followed exactly, a fire or explosion could result causing property damage, personal injury or loss of life.

- Do not store or use gasoline or other flammable vapors and liquids in the vicinity of this or any other appliance.
- **WHAT TO DO IF YOU SMELL OIL:**
- Do not try to light any appliance.
- Do not touch any electrical switch; do not use any phone in your building.
 - Immediately call your fuel supplier from a neighbor's phone. Follow the fuel supplier's instructions.
 - If you cannot reach your fuel supplier, call the fire department.
- Installation and service must be performed by a qualified installer, service agency or the fuel supplier.

Do not use this furnace if any part has been under water. Immediately call a qualified service technician to inspect the furnace and to replace any part of the control system and any oil control which has been under water.

⚠ WARNING: CARBON MONOXIDE POISONING HAZARD

Failure to follow this warning could result in personal injury or death.

Carbon Monoxide is invisible, odorless, and toxic! Bryant recommends a carbon monoxide alarm in your home, even if you do not own a gas appliance. Locate the carbon monoxide alarm in the living area of your home and away from gas appliances and doorways to attached garages. Follow the alarm manufacturer's instruction included with the alarm.

WELCOME TO A NEW GENERATION OF COMFORT

Congratulations! In light of rising energy costs, the 374RAN Variable Speed Multipoise Oil Furnace is among the soundest investments today's homeowner can make.

Your new furnace is truly a triumph of technology in home heating. A unique silencer within the heat exchanger, insulated cabinet, and rubber blower mounts make it among the quietest units on the market. Variable speed technology creates more comfortable heating and cooling cycles, allows you to economically run a constant fan, and eliminates temperature difference throughout the house. The combustion chamber is stainless steel for long life and it heats up quickly resulting in enhanced comfort and energy efficiency.

With only minimal care, your new furnace will deliver many years of money-saving home comfort and enjoyment. Spend just a few minutes with this manual to learn the operation of your new furnace and the small amount of maintenance it takes to help keep it operating at peak efficiency year after year.

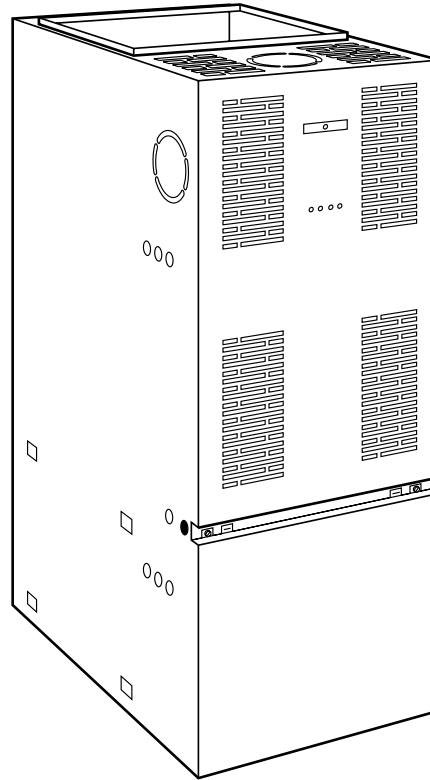

MODEL 374RAN MULTIPOISE FURNACE

1

INSTALLATION DATA

Date Installed _____
 Dealer Name _____
 Address _____
 City _____
 State _____ Zip _____
 Telephone _____

FURNACE

Product No. _____
 Model No. _____
 Serial No. _____

SPLIT-SYSTEM

OUTDOOR UNIT:
 Product No. _____
 Model No. _____
 Serial No. _____
 INDOOR COIL:
 Product No. _____
 Model No. _____
 Serial No. _____

ACCESSORIES

Product No. _____
 Model No. _____
 Serial No. _____

FURNACE COMPONENTS

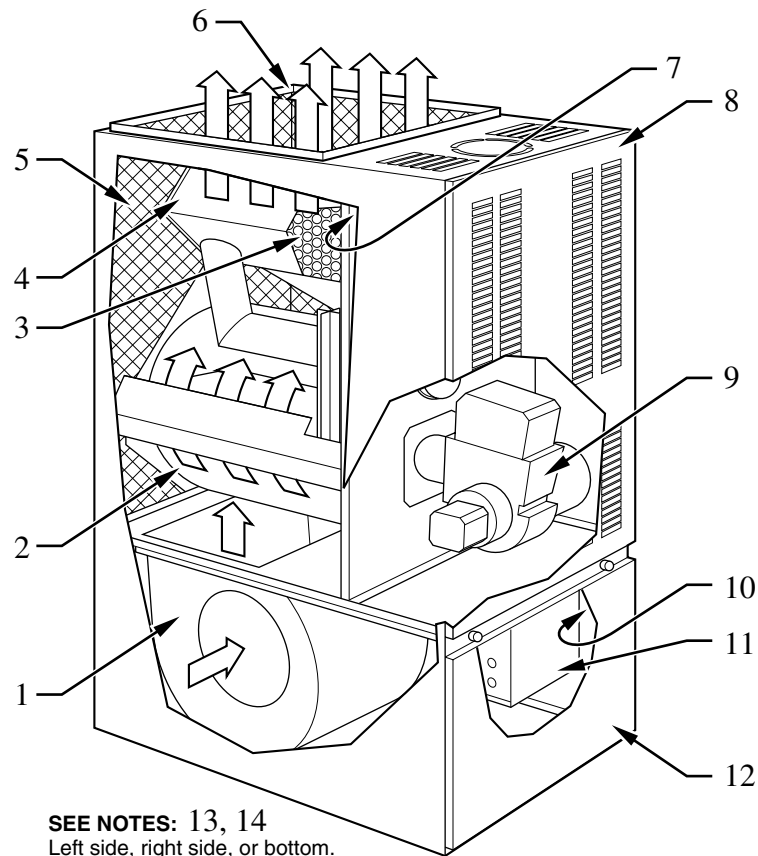

2

- | | |
|---|--|
| <p>1 Variable Speed blower circulates air across the heat exchanger to transfer heat into the home.</p> <p>2 Stainless steel combustion chamber/primary heat exchanger.</p> <p>3 Unique silencer system reduces combustion noise.</p> <p>4 Heat exchanger designed and shaped to efficiently transfer heat from furnace into the home.</p> <p>5 Fully insulated internal walls to minimize heat loss.</p> <p>6 Supply-air plenum.</p> <p>7 High limit control to prevent overtemperature operation.</p> | <p>8 Reversible door provides easy access to burner and controls.</p> <p>9 High-performance oil burner.</p> <p>10 Adjustable electronic fan control (inside) with low-voltage electrical terminal strip for easy connection of thermostat, cooling control, electronic air cleaner, and humidifier.</p> <p>11 Access door to air filters and blower.</p> <p>12 Air filter (field-supplied).</p> <p>13 Return-air plenum.</p> |
|---|--|

IMPORTANT FACTS

Your furnace must have adequate airflow for efficient combustion and safe ventilation. Do not enclose it in an airtight room or “seal” it behind solid doors.

To minimize the possibility of serious personal injury, fire, furnace damage, or improper operation, **carefully follow these safety rules:**

FOR YOUR SAFETY

Do not store or use gasoline or other flammable vapors and liquids in the vicinity of this or any other appliance.

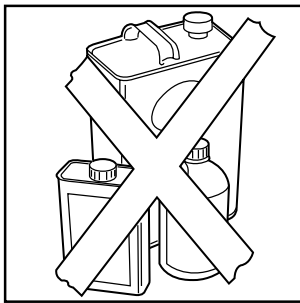

3

- Do not cover the furnace, store trash or debris near it, or in any way block the flow of fresh air to the unit.
- Combustion air must be clean and not contaminated with chlorine or fluorine. These compounds are present in many products around the home, such as: water softener salts, laundry bleaches, detergents, adhesives, paints, varnishes, paint strippers, waxes, and plastics.

Make sure the combustion air for your furnace does not contain any of these compounds. During remodeling be sure the combustion air is fresh and uncontaminated. If air with vapors of these compounds is burned in your furnace, the heat exchangers and metal vent system may deteriorate.

NOTE: Do not use this furnace if any part has been under water.

Immediately call a qualified service technician to inspect the furnace and to replace any part of the control system, electrical components, and any oil control which has been under water.

NOTE: The qualified installer or agency must use only factory-authorized replacement parts, kits, and accessories when servicing this product.

The furnace burner control has a safety device which must be manually reset. If the furnace is left unattended for an extended period of time, have it checked periodically for proper operation. This precaution will prevent problems associated with no heat, such as frozen water pipes, etc.

SAFETY CONSIDERATIONS

Installing and servicing of heating equipment can be hazardous due to oil and electrical components. Only trained and qualified personnel should install, repair, or service heating equipment.

Untrained personnel can perform basic maintenance functions such as cleaning and replacing air filters. All other operations must be performed by trained service personnel. Observe safety precautions in this manual, on tags, and on labels attached to the furnace and other safety precautions that may apply.

Recognize safety information. This is the safety-alert symbol ⚠. When you see this symbol on the furnace and in instructions or manuals, be alert to the potential for personal injury.

Understand the signal words — DANGER, WARNING, and CAUTION. These words are used with the safety-alert symbol. DANGER identifies the most serious hazards which **will** result in severe personal injury or death. WARNING signifies hazards which **could** result in personal injury or death. CAUTION is used to identify unsafe practices which **may** result in

minor personal injury or product and property damage. NOTE is used to highlight suggestions which will result in enhanced installation, reliability or operation.

⚠ WARNING

FIRE, EXPLOSION, CARBON MONOXIDE POISONING HAZARD

Failure to follow this warning could lead to sooting, fire, explosion, and/or severe bodily harm.

For use with grade 2 Fuel Oil maximum. Do not use Gasoline, Crankcase Oil, or any Oil containing Gasoline!

⚠ CAUTION

FIRE AND UNIT OVERHEAT HAZARD

Failure to follow this caution may result in unit damage. Never burn garbage or paper in the heating system and never leave rags, paper, or any flammable items around the unit.

STARTING YOUR FURNACE

This appliance is equipped with an ignition device which automatically lights the burner each time the thermostat starts your furnace. **Follow these important safeguards:**

⚠ WARNING

EXPLOSION HAZARD

Failure to follow this warning could result in property damage or personal injury or death.

This furnace is equipped with a constant type primary ignition system. DO NOT ATTEMPT TO LIGHT WITH A MATCH.

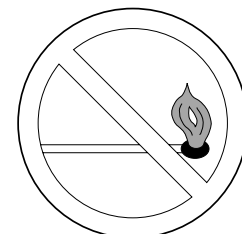

4

⚠ DANGER

ELECTRICAL SHOCK HAZARD HIGH VOLTAGE AT IGNITER.
Severe electrical shock, personal injury, or death could result.

- If a suspected malfunction occurs with your oil control system, such as the burner not lighting when it should, refer to the “Shutting Down Your Furnace” section and call your dealer as soon as possible.

CHECK AIR FILTER: Before attempting to start your furnace, be sure the furnace air filter is clean and in place. See “Performing Routine Maintenance” section in this manual. Then proceed as follows:

STEPS FOR STARTING YOUR FURNACE

1. Open all warm air registers and make sure that all return-air grills are unobstructed.
2. If a humidifier is installed with your system, open water supply valve.
3. Make sure blower access door is secured in place.
4. Set your room thermostat to lowest temperature setting.
(See Fig. 5.)

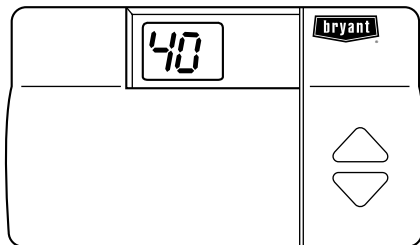

5

5. Turn on electric power to furnace. (See Fig. 6.)

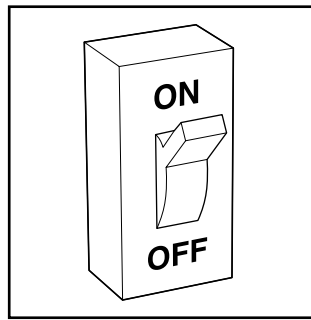

6

6. Open oil supply valve.
(See Fig. 7.)

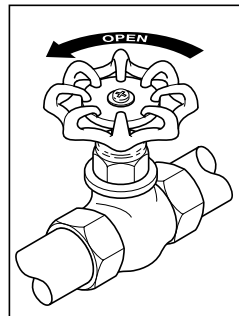

7

7. Check all connections to ensure there are no leaks.
8. Set room thermostat to a temperature slightly above room temperature. This will automatically signal the furnace to start.
9. When the thermostat calls for heat, power from the transformer energizes the fan control board. The fan control energizes the ignition control. The ignition control will automatically light the burner.

The electronic fan control automatically turns on the blower. The air moved over the heat exchanger by the blower is warmed and passes through the ducts to the room registers.

This unit is equipped with continuous ignition control. If the main burner does not ignite within 30 sec from the call for heat, the control will lock out. The red button on top of the control must be depressed for 3 sec in order to reset the control.

The control CANNOT be reset from the room thermostat.

10. Set your thermostat to the temperature that satisfies your comfort requirements. **SUGGESTION:** Setting the thermostat back a few degrees and compensating for the difference with warmer clothing can make a big difference in your fuel consumption on extremely cold days. The few degrees at the top of your thermostat “comfort level” are the most costly degrees to obtain.

When room temperature drops below temperature selected on the thermostat, the furnace will be switched on automatically. When room temperature reaches the degree selected on the thermostat, the furnace will be switched off automatically.

Some thermostats have a FAN mode with 2 selections, AUTO and ON. When thermostat is set to AUTO, the furnace blower cycles on and off, controlled by the thermostat. In ON mode, the furnace blower runs continuously. This keeps the temperature level in your home more evenly balanced. It also continuously filters indoor air.

SHUTTING DOWN YOUR FURNACE

Should you need to shut down your furnace for service or maintenance, you will need to turn the furnace off. The following procedures must be followed:

1. Set thermostat to lowest setting.
(See Fig. 8.)

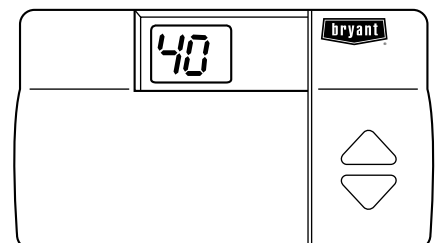

8

- Turn off all electrical power to the furnace. (See Fig. 9.)

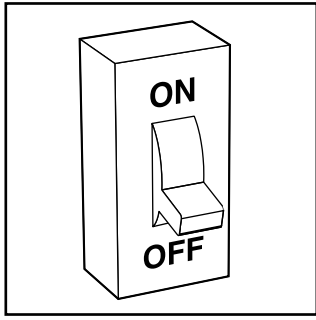

9

- Close oil supply valve. (See Fig. 10).

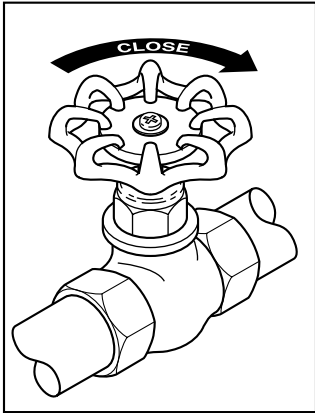

10

- If applicable, turn off water supply to humidifier.
- If furnace blower will be necessary for cooling system, remember to turn electric power back on when needed for air conditioning.
- If furnace is being shut down because of a malfunction, call your dealer as soon as possible.

ALWAYS KEEP MAIN OIL VALVE TURNED OFF IF BURNER IS SHUT DOWN FOR AN EXTENDED PERIOD OF TIME.

PERFORMING ROUTINE MAINTENANCE

With proper maintenance and care, your furnace will operate economically and dependably. Instructions for basic maintenance follow. However, before beginning maintenance, follow these safety precautions:

⚠ WARNING

ELECTRICAL SHOCK HAZARD
Failure to follow this warning could result in personal injury or death.
Turn off all electrical power to furnace before performing any maintenance or service on unit.

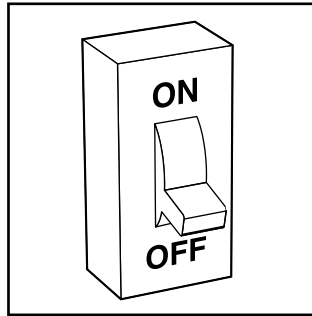

11

⚠ CAUTION

CUT HAZARD
Failure to follow this caution may result in personal injury. Although special care has been taken to minimize sharp edges, be extremely careful when handling parts or reaching into the furnace.

FILTERING OUT TROUBLE

Dirty air filters will cause a loss of airflow in your duct system. When excessive loss of airflow occurs, the furnace may cycle on its safety controls. If this condition is left unattended, the furnace will eventually lock out. It is recommended that furnace air filters be checked every 3 or 4 weeks and cleaned or replaced as necessary.

⚠ CAUTION

UNIT DAMAGE HAZARD
Failure to follow this caution may result in reduced unit component life.
Never operate your furnace without the air filters in place. Doing so may damage the furnace blower motor. An accumulation of dust and lint on internal parts of your furnace can cause a loss of efficiency.

The air filter is installed in an external filter rack which is provided as standard equipment with furnace.

To inspect, clean, and/or replace air filter, follow these steps:

- Turn off electrical supply to furnace. (See Fig. 11.)
- Remove filter from external filter rack.
- Inspect filter. If torn, replace it.

NOTE: If filter has been replaced with an electronic air cleaner (EAC), refer to the EAC Owner's Manual for maintenance information.

- If filter is dirty, it must be replaced. If your furnace air filter needs to be replaced, be sure to use the same size and type of filter that was originally supplied. Use furnace filter table for filter size and filter rack flange dimensions for return air duct.

FURNACE AIR FILTER TABLE

FLANGE OPENING SIZE (IN.)	FILTER SIZE (IN.)	FILTER TYPE
Model Size 105		
15 X 23	16 X 24 X 1 or 16 X 25 X 1	Disposable
Model Size 120		
19 X 29	18 X 30 X 1 or 20 X 30 X 1	Disposable

If you have replaced a disposable filter with a permanent washable filter, it may be cleaned if it is dirty.

Wash filter in a sink, bathtub, or outside with a garden hose. Always use cold tap water. A mild liquid detergent may be used if necessary. Spray water through filter in the opposite direction of airflow. Allow filter to dry.

5. Re-install clean air filter.
6. Turn on electrical supply to furnace.

A CHECK-UP CHECKLIST

Your furnace represents an important investment in your family's comfort and your home's value. To keep it performing properly and as a preventative to future problems, have a trained service specialist give your furnace a professional check-up annually. The following checklist can be used as a guideline to proper service:

- Check flue and secondary tube passage ways including chimney — clean if necessary.
- Change oil filter.
- Change nozzle.
- Check and adjust combustion and draft.
- Inspect all vent piping inside structure for deterioration and vent terminations outside the structure for blockage.
- Check oil pipes leading to and inside of your furnace for leaks.

- Inspect and clean the blower motor and wheel.
- Inspect and change or clean air filter if necessary.
- Inspect all supply- and return-air ducts for obstructions, air leaks, and insulation. Remedy any problem when necessary.
- Inspect the return-air duct connections at the furnace to ensure it is physically sound, sealed to the furnace casing, and terminates outside the space containing the furnace.
- Inspect electrical wiring, connections, and components for loose connections.
- Examine the physical support of the furnace. Support should be sound with no cracks, sagging, gaps, etc. around the base.
- Check furnace for any obvious signs of deterioration.

BEFORE YOU REQUEST A SERVICE CALL

If your furnace is not operating or not performing properly, you may save the expense of a service call by checking a few things yourself before calling for service.

FOR INSUFFICIENT AIRFLOW:

- Check for dirty air filters.
- Check for blocked return-air or

supply-air grilles throughout your home. Ensure they are open and unobstructed.

If problem still exists, call your dealer for service.

IF FURNACE FAILS TO OPERATE:

Follow this checklist step by step, advancing to the next step only if furnace fails to start.

- Check thermostat for proper temperature. Is thermostat set above room temperature?
- Is thermostat set on HEAT?
- Check fuses and circuit breakers. Is electrical supply on?
- Is valve in oil supply pipe in open position?
- Is the ignition control on the burner not in lockout? The red button on top of the control must be depressed for 3 sec in order to reset the control.
- Check for obstructions around the vent termination.

If furnace still fails to operate, call your service representative. For your convenience, record furnace product and serial numbers on page 2. Should you ever require service, you will have ready access to the information needed by your service representative.

