

The Boiler Control 261 is designed to control two separate on / off boiler stages (or one low / high fire) in order to provide outdoor reset or setpoint operation. The control includes a Liquid Crystal Display (LCD) to view system status and operating information.

Additional functions include:

- Quick Setup for simple installation and programming of control
- User comfort adjustment to increase or decrease building space temperature
- Advanced settings to fine-tune building requirements
- Powered boiler pump output
- Test sequence to ensure proper component operation
- Setback input for energy savings
- 120 V (ac) power supply
- CSA C US certified (approved to applicable UL standards)

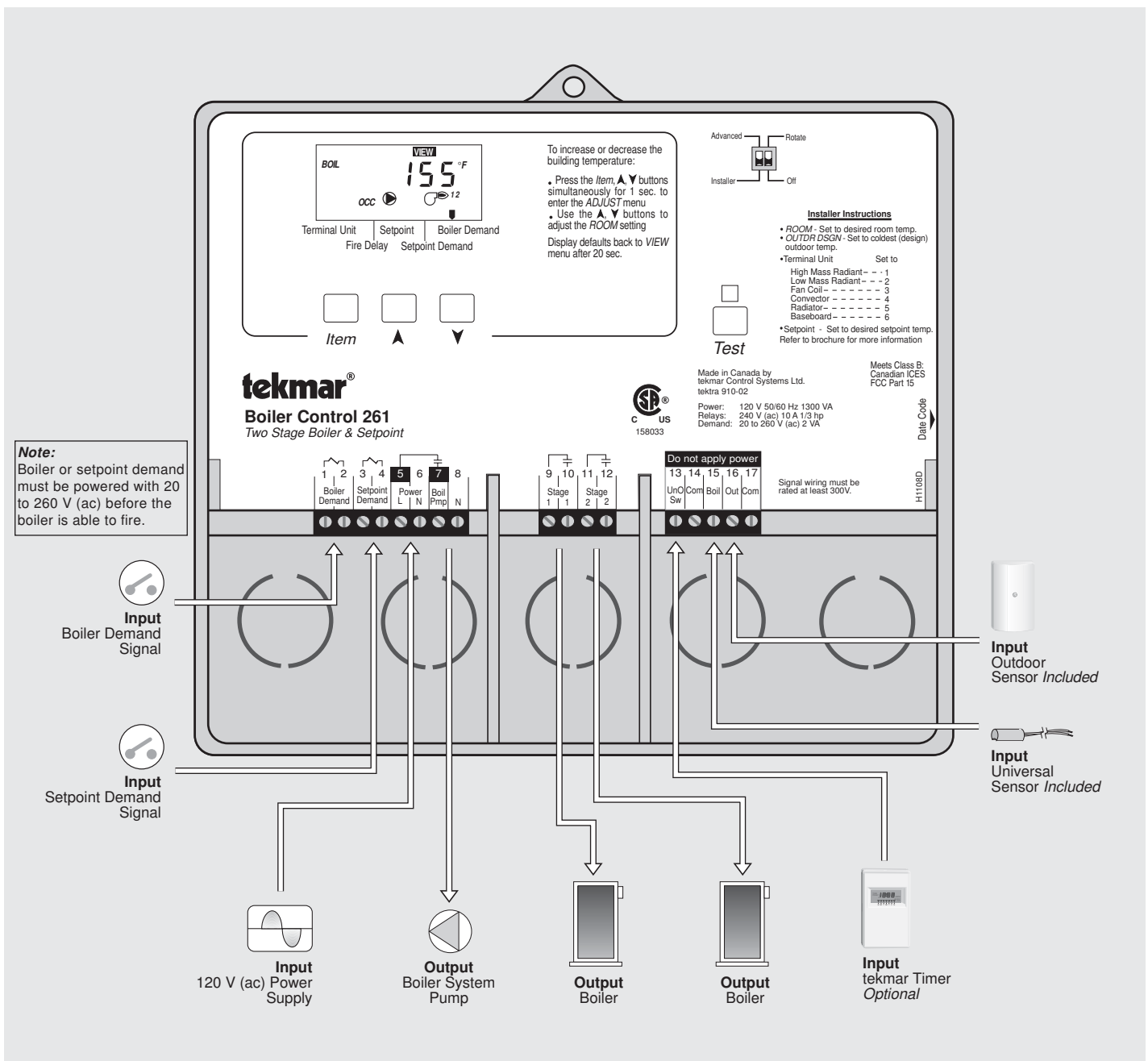

How To Use The Data Brochure

This brochure is organized into four main sections. They are: 1) *Sequence of Operation*, 2) *Installation*, 3) *Control Settings*, and 4) *Troubleshooting*. The *Sequence of Operation* section has three sub-sections. We recommend reading Section A: *General Operation* of the *Sequence of Operation*, as this contains important information on the overall operation of the control. Then read the sub-sections that apply to your installation. For quick installation and setup of the control refer to the *Installation* section, *DIP Switch Settings* section, followed by the *Quick Setup* section.

The *Control Settings* section (starting at *DIP Switch Settings*) of this brochure, describes the various items that are adjusted and displayed by the control. The control functions of each adjustable item are described in the *Sequence of Operation*.

Table of Contents

User Interface	pg 2	Quick Setup	pg 13
Description of Display Elements	pg 3	Control Settings	pg 14
Sequence of Operation	pg 4	View Menu	pg 14
Section A: General Operation	pg 4	Adjust Menu	pg 14
Section B: Boiler Reset	pg 5	Testing and Troubleshooting	pg 16
Section C: Setpoint	pg 8	Error Messages	pg 18
Installation	pg 9	Technical Data	pg 20
DIP Switch Settings	pg 12	Limited Warranty	pg 20

Reference Material: Essay E 003 "Characterized Heating Curve and Reset Ratio"

User Interface

The 261 uses a Liquid Crystal Display (LCD) as the method of supplying information. You use the LCD in order to set up and monitor the operation of your system. The 261 has three push buttons (**Item**, ▲, ▼) for selecting, viewing, and adjusting settings. As you program your control, record your settings in the ADJUST menu table which is found in the second half of this brochure.

Item

The abbreviated name of the selected item will be displayed in the item field of the display. To view the next available item, press and release the **Item** button. Once you have reached the last available item, pressing and releasing the **Item** button will return the display to the first item.



Adjust

To make an adjustment to a setting in the control, press and hold simultaneously for 1 second, all 3 buttons. The display will then show the word ADJUST in the top right corner. Then select the desired item using the **Item** button. Finally, use the ▲ and / or ▼ button to make the adjustment.

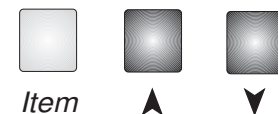

To exit the ADJUST menu, either select the ESC item and press the ▲ or ▼ button, or leave the adjustment buttons alone for 20 seconds.



When the **Item** button is pressed and held in the VIEW menu, the display scrolls through all the adjust items in both access levels.

Additional information can be gained by observing the status field and pointers of the LCD. The status field will indicate which of the control's outputs are currently active. Most symbols in the status field are only visible when the VIEW menu is selected.

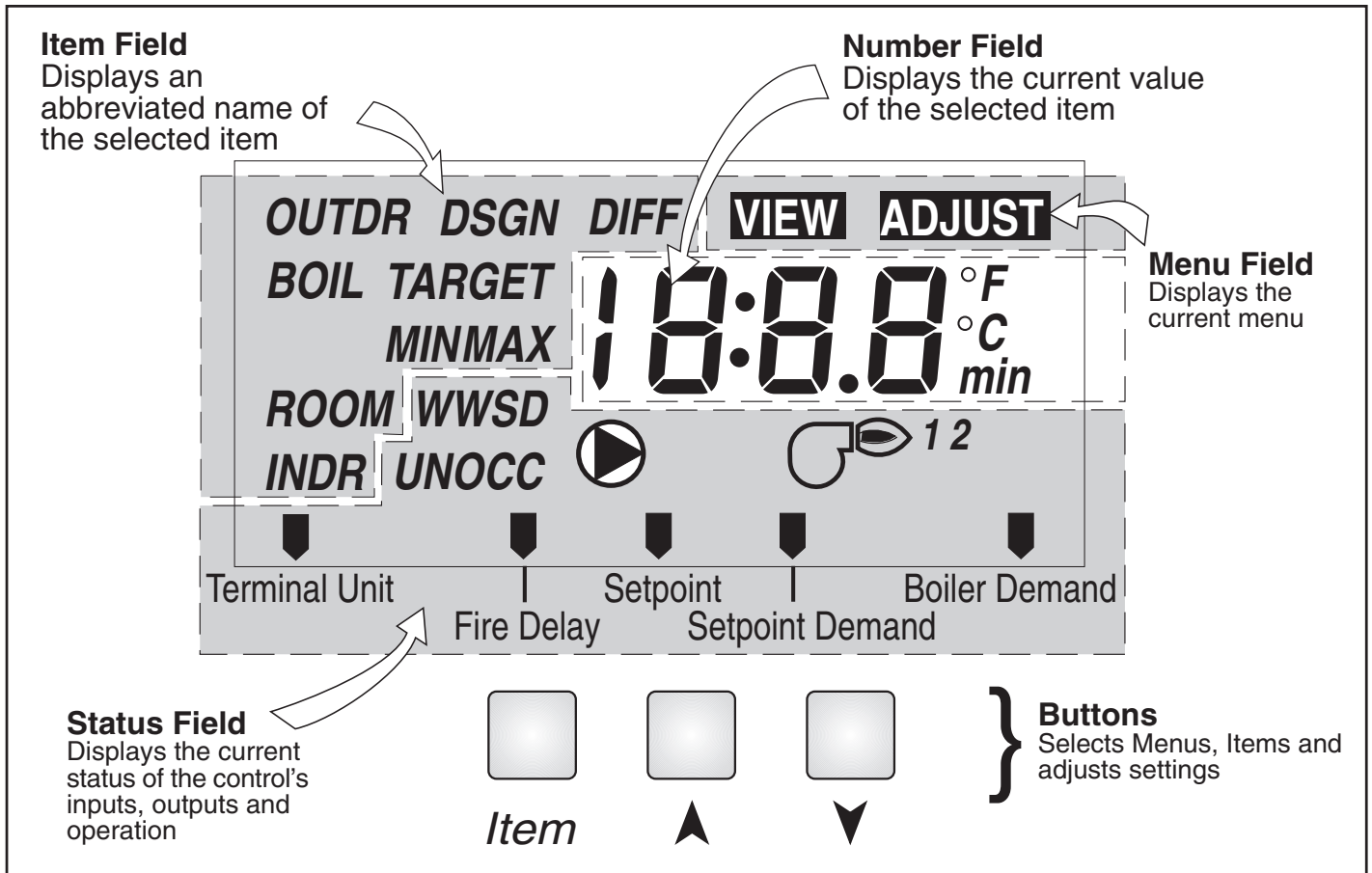
Display



Symbol Description

	Pump Displays when the boiler pump is in operation.	<i>UNOCC</i>	Unoccupied Schedule Displays when the control is in unoccupied (Night) mode.
	Burner Displays when the stage 1 and / or stage 2 relay is turned on.	<i>°F, °C</i>	°F, °C Displays the unit of measure that all of the temperatures are to be displayed in the control.
<i>OCC</i>	Occupied Schedule Displays when the control is in occupied (Day) mode.		Pointer Displays the control operation as indicated by the text.

Sequence of Operation

Section A
General Operation
Page 4

Section B
Boiler Reset
Page 5-8

Section C
Setpoint
Page 8

Section A — General Operation

POWERING UP THE CONTROL

When the Boiler Control 261 is powered up, the control displays the control type number in the LCD for 2 seconds. Next, the software version is displayed for 2 seconds. Finally, the control enters into the normal operating mode and the LCD defaults to displaying the current outdoor air temperature.

OPERATION

The 261 operates two on / off heat sources to control the supply water temperature to a hydronic system. The supply water temperature is based on either the current outdoor temperature, or a fixed setpoint.

Outdoor Reset

When a demand signal from the heating system is present, the 261 calculates a supply temperature based on the outdoor air temperature and *Characterized Heating Curve* settings.

Setpoint Control

When a demand signal from a setpoint system is present, the control operates the boiler(s) to maintain the supply water temperature at the *Setpoint* setting. Refer to section C.

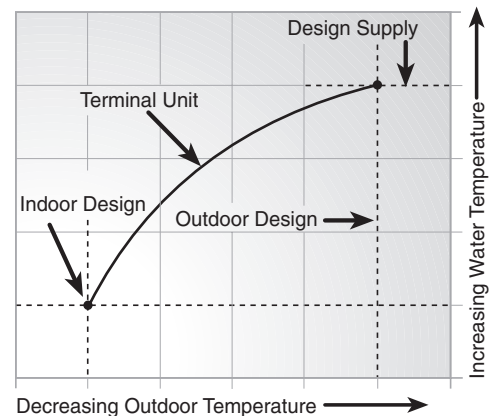

SETBACK (UNOCCUPIED)

To provide greater energy savings, the 261 has a setback capability. With setback, the supply water temperature in the system is reduced when the building is unoccupied. By reducing the supply water temperature, air temperature in the space may be reduced even when thermostat(s) are not turned down. Any time the *UnO Sw* (13) and the *Com* (14) terminals are shorted together, the control operates in the unoccupied (Night) mode. When in the unoccupied (Night) mode, the UNOCC segment is displayed in the LCD. The 261 adjusts the supply water temperature based on the UNOCC settings made in the control. This feature has no effect when the control is used in setpoint operation.

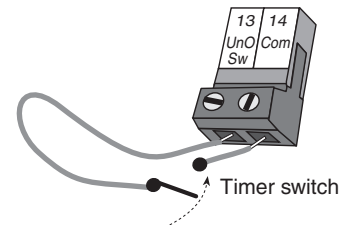

ROTATION

The 261's *Equal Run Time Rotation* function is fixed at 48 hours. The firing order of the boilers changes whenever one stage accumulates 48 hours more running time than the other stage. After each rotation, the stage with the least running hours is the first to fire, and the stage with the most running hours is the last to fire. This function ensures that both stages receive equal amounts of use. When the *Rotate / Off* DIP switch is set to the *Off* position, Stage 1 is always the first stage to fire.

EXERCISING

The 261 has a built-in exercising function. If the pump has not been operated at least once every 3 days, the control turns on the output for 10 seconds. This minimizes the possibility of the pump seizing during a long period of inactivity. While the control is exercising, the *Test* LED flashes.

Note: The exercising function does not work if power to the control or pump is disconnected.

FACTORY DEFAULTS

The control comes preset with several factory defaults. These defaults are based on the terminal unit selection (see section B2). To fine-tune building requirements, these defaults may be changed. If a factory default value for a terminal unit is changed, the terminal unit number will flash when selected in the ADJUST menu.

To reload the factory defaults listed in section B2, power down the control and wait for 10 seconds. Power up the control while simultaneously holding the *Item* and *▼* buttons. The terminal unit number should now be displayed constantly in the LCD rather than flashing.

Section B: Boiler Reset

Section B1
General

Section B2
Installer

Section B3
Advanced

Section B1: General

BOILER DEMAND

A boiler demand is required in order for the 261 to provide heat to the heating system. A boiler demand is generated by applying a voltage between 24 and 240 V (ac) across the *Boiler Demand* terminals (1 and 2). Once voltage is applied, the *Boiler Demand* pointer is displayed in the LCD. If the 261 is not in WWSD, the 261 closes the *Boil Pmp* contact. The 261 calculates a boiler target (BOIL TARGET) supply temperature based on the outdoor air temperature and settings. The 261 then fires the boiler(s), if required, to maintain the target supply temperature.

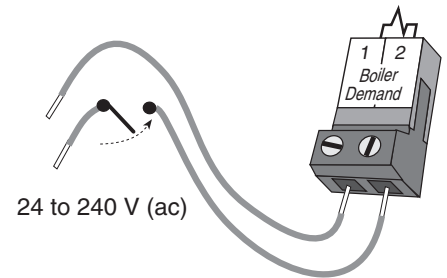

BOILER PUMP OPERATION (BOIL PMP)

The boiler pump contact (*Boil Pmp*, terminal 7) closes whenever there is a boiler demand and the 261 is not in WWSD. The boiler pump segment is displayed in the LCD. After the boiler demand has been satisfied, the 261 continues to operate the boiler pump for 20 seconds. This allows any excess heat to be purged out to the heating system. During WWSD, the boiler pump is operated based on the exercise function. For boiler pump contact operation during setpoint operation, refer to section C.

BOILER OPERATION

When the 261 determines that boiler operation is required, the boiler *Stage* contact(s) (9 and 10 and / or 11 and 12) close. While the boiler contact(s) is closed, the burner and stage segment in the LCD is displayed.

STAGING

The 261 controls up to two stages in order to supply the required target temperature. After the first stage is turned on in the firing sequence, the control waits a minimum amount of time before turning on the next stage. After the minimum time delay between stages has expired, the 261 examines the control error to determine when the next stage is to fire. The control error is determined using Proportional, Integral and Derivative (PID) logic.

Proportional - compares the actual supply temperature (BOIL) to the boiler target (BOIL TARGET) temperature. The colder the supply water temperature, the sooner the next stage is turned on.

Integral - compares the actual supply temperature (BOIL) to the boiler target (BOIL TARGET) temperature over a period of time.

Derivative - determines how fast or slow the supply water temperature is changing. If the supply temperature is increasing slowly, the next stage is turned on sooner. If the supply temperature is increasing quickly, the next stage is turned on later, if at all.

Each stage has a minimum on time, and a minimum off time.

CHARACTERIZED HEATING CURVE

The 261 varies the supply water temperature based on the outdoor air temperature. The control takes into account the type of terminal unit that the system is using. Since different types of terminal units transfer heat to a space using different proportions of radiation, convection and conduction, the supply water temperature must be controlled differently. Once the control is told what type of terminal unit is used, the control varies the supply water temperature according to the type of terminal unit. This improves the control of the air temperature in the building.

BOILER TARGET TEMPERATURE (BOIL TARGET)

The BOIL TARGET temperature is determined from the *Characterized Heating Curve* settings and the outdoor air temperature. The control displays the temperature that it is currently trying to maintain as the boiler supply temperature. If the control does not presently have a requirement for heat, it does not show a boiler target temperature. Instead, “- -” is displayed in the LCD.

Section B2: Installer

OUTDOOR DESIGN (OUTDR DSGN)

The OUTDR DSGN is the outdoor air temperature that is the typical coldest temperature of the year where the building is located. This temperature is used when doing the heat loss calculations for the building. If a cold outdoor design temperature is selected, the boiler supply temperature rises gradually as the outdoor temperature drops. If a warm outdoor design temperature is selected, the boiler supply temperature rises rapidly as the outdoor temperature drops.

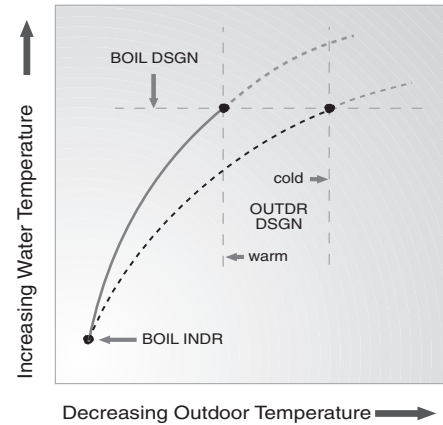

ROOM OCC & UNOCC (ROOM)

The ROOM is the desired room temperature for the boiler zones, and it provides a parallel shift of the *Characterized Heating Curve*. The room temperature desired by the occupants is often different from the design indoor temperature (BOIL INDR). If the room temperature is not correct, adjusting the ROOM setting increases or decreases the amount of heat available to the building. A ROOM setting is available for both the occupied (Day) and unoccupied (Night) modes.

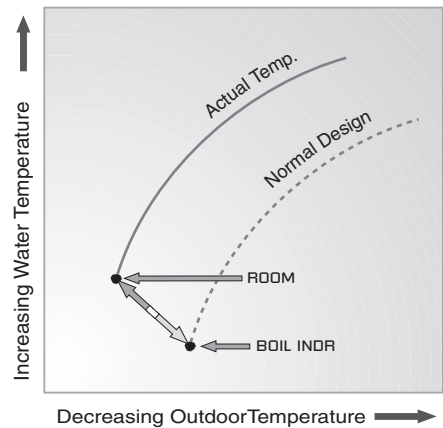

TERMINAL UNITS

When using a *Characterized Heating Curve*, the control requires the selection of a terminal unit. The terminal unit determines the shape of the *Characterized Heating Curve* according to how the terminal unit delivers heat into the building space (refer to Essay E 003). The 261 provides for selection between six different terminal unit types: two types of radiant floor heat, fancoil, fin-tube convector, radiator and baseboard. When a terminal unit is selected, the control automatically loads the design supply temperature (BOIL DSGN), maximum supply temperature (BOIL MAX), and minimum supply temperature (BOIL MIN). The factory defaults are listed below. To change defaults, refer to section B3. If a default has been changed, refer to section A to reload the factory defaults.

Terminal Unit	High Mass Radiant (1)	Low Mass Radiant (2)	Fancoil (3)	Fin-tube Convector (4)	Radiator (5)	Baseboard (6)
BOIL DSGN	120°F (49°C)	140°F (60°C)	190°F (88°C)	180°F (82°C)	160°F (71°C)	150°F (66°C)
BOIL MAX	140°F (60°C)	160°F (71°C)	210°F (99°C)	200°F (93°C)	180°F (82°C)	170°F (77°C)
BOIL MIN	OFF	OFF	140°F (60°C)	140°F (60°C)	140°F (60°C)	140°F (60°C)

High Mass Radiant (1)

This type of a hydronic radiant floor is embedded in either a thick concrete or gypsum pour. This heating system has a large thermal mass and is slow acting.

Default values: BOIL DSGN = 120°F (49°C), BOIL MAX = 140°F (60°C), BOIL MIN = OFF

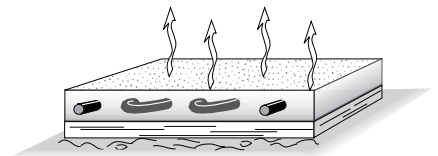

Low Mass Radiant (2)

This type of radiant heating system is either attached to the bottom of a wood sub-floor, suspended in the joist space, or sandwiched between the sub-floor and the surface. This type of radiant system has a relatively low thermal mass and responds faster than a high mass system.

Default values: BOIL DSGN = 140°F (60°C), BOIL MAX = 160°F (71°C), BOIL MIN = OFF

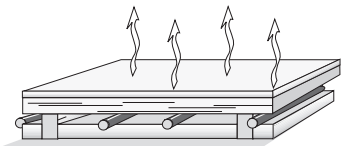

Fancoil (3)

A fancoil terminal unit or air handling unit (AHU) consists of a hydronic heating coil and either a fan or blower. Air is forced across the coil at a constant velocity by the fan or blower, and is then delivered into the building space.

Default values: BOIL DSGN = 190°F (88°C), BOIL MAX = 210°F (99°C),
BOIL MIN = 140°F (60°C)

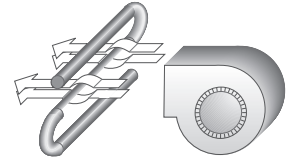

Fin-tube Convectector (4)

A convectector terminal unit is made up of a heating element with fins on it. This type of terminal unit relies on the natural convection of air across the heating element to deliver heated air into the space. The amount of natural convection to the space is dependant on the supply water temperature to the heating element and the room air temperature.

Default values: BOIL DSGN = 180°F (82°C), BOIL MAX = 200°F (93°C),
BOIL MIN = 140°F (60°C)

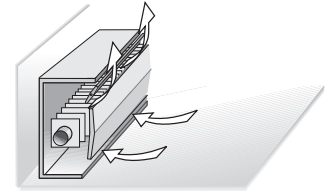

Radiator (5)

A radiator terminal unit has a large heated surface that is exposed to the room. A radiator provides heat to the room through radiant heat transfer and natural convection.

Default values: BOIL DSGN = 160°F (71°C), BOIL MAX = 180°F (82°C),
BOIL MIN = 140°F (60°C)

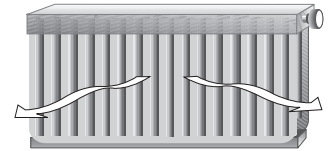

Baseboard (6)

A baseboard terminal unit is similar to a radiator, but has a low profile and is installed at the base of the wall. The proportion of heat transferred by radiation from a baseboard is greater than that from a fin-tube convectector.

Default values: BOIL DSGN = 150°F (66°C), BOIL MAX = 170°F (77°C),
BOIL MIN = 140°F (60°C)



Section B3: Advanced

BOILER INDOOR (BOIL INDR)

The BOIL INDR is the room temperature used in the original heat loss calculations for the building. This setting establishes the beginning of the *Characterized Heating Curve* for the boiler zones.

BOILER DESIGN (BOIL DSGN)

The BOIL DSGN temperature is the supply water temperature required to heat the boiler zones when the outdoor air temperature is as cold as the OUTDR DSGN temperature.

BOILER MAXIMUM (BOIL MAX)

The BOIL MAX is the highest water temperature that the control is allowed to calculate as the BOIL TARGET temperature. If the control does target the BOIL MAX setting, and the BOIL temperature is near the BOIL MAX temperature, the MAX segment will be displayed in the LCD while either the BOIL TARGET temperature or the BOIL temperature is being viewed. At no time does the control operate the boiler above 248°F (120°C).

BOILER MINIMUM (BOIL MIN)

The BOIL MIN is the lowest water temperature that the control is allowed to use as the BOIL TARGET temperature. During mild conditions, if the 261 calculates a BOIL TARGET temperature that is below the BOIL MIN setting, the BOIL TARGET temperature is adjusted to at least the BOIL MIN setting. During this condition, if the boiler is operating, the MIN segment turns on in the LCD while the BOIL TARGET or BOIL temperature is being viewed. If the installed boiler is designed for low temperature operation, set the BOIL MIN adjustment to OFF.

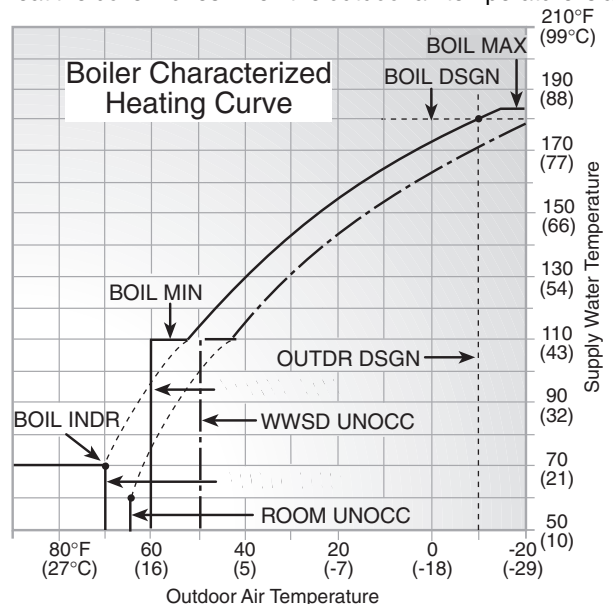

FIRE DELAY (Fire Delay)

The Fire Delay is the delay time that may occur between the time that the 261 closes a stage contact, and the burner fires for that stage. This delay is usually the result of burner pre-purge, or other forms of time delay built into the burner's safety circuits.

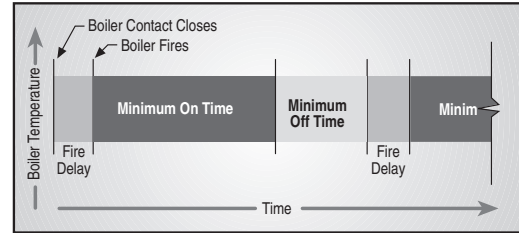

BOILER DIFFERENTIAL (BOIL DIFF)

An on / off heat source such as a boiler must be operated with a differential in order to prevent short cycling. With the 261, either a fixed or an auto differential may be selected.

Fixed Differential

The boiler differential is divided around the BOIL TARGET temperature. The contact will close when the supply water temperature is 1/2 of the differential setting below the BOIL TARGET temperature, and will open when the supply water temperature is 1/2 of the differential setting above the BOIL TARGET temperature.

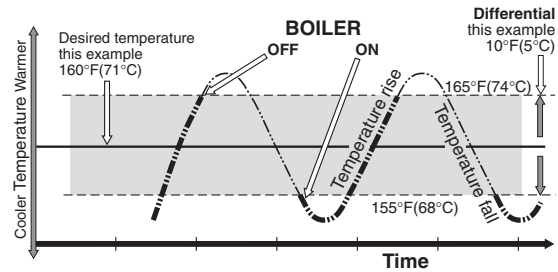

Auto Differential (Ad)

If the Auto Differential is selected, the 261 automatically determines the best differential as the load changes. This setting is recommended as it reduces potential short cycling during light loads.

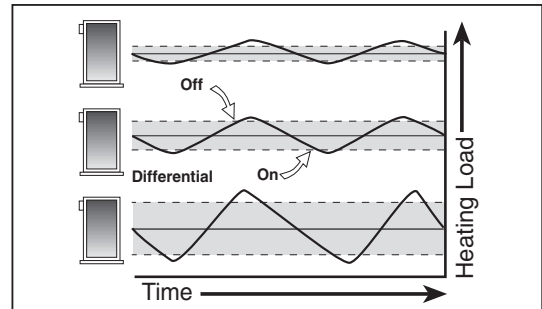

WARM WEATHER SHUT DOWN (WWSD) OCC & UNOCC

When the outdoor air temperature rises above the WWSD setting, the 261 turns on the WWSD segment in the display. When the control is in Warm Weather Shut Down, the *Boiler Demand* pointer is displayed, if there is a demand. However, the control does not operate the heating system to satisfy this demand. The control does respond to a setpoint demand and operates as described in section C.

Section C: Setpoint

SETPOINT DEMAND

A setpoint demand is required in order for the 261 to provide heat to the setpoint load. The 261 registers a setpoint demand when a voltage between 24 and 240 V (ac) is applied across the *Setpoint Demand* terminals (3 and 4). Once voltage is applied, the *Setpoint Demand* pointer turns on in the LCD. The control operates the boiler(s) to maintain at least the *Setpoint* setting. The setpoint demand does not turn on the boiler pump. If a setpoint load is used, the installer must make sure that the setpoint device provides its own flow through the boiler(s).

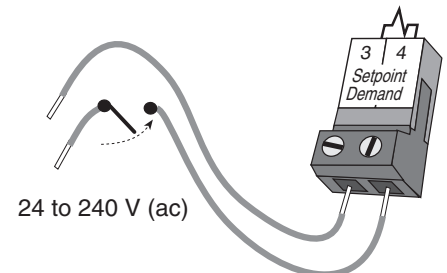

BOILER TARGET DURING SETPOINT (BOIL TARGET)

The BOIL TARGET during a setpoint demand is increased to at least the *Setpoint* setting. This temperature is maintained as long as the 261 has a setpoint demand.

Installation

CAUTION

Improper installation and operation of this control could result in damage to the equipment and possibly even personal injury. It is your responsibility to ensure that this control is safely installed according to all applicable codes and standards. This electronic control is not intended for use as a primary limit control. Other controls that are intended and certified as safety limits must be placed into the control circuit.

STEP ONE — GETTING READY

Check the contents of this package. If any of the contents listed are missing or damaged, please contact your wholesaler or tekmar sales representative for assistance.

Type 261 includes: One Boiler Control 261, One Outdoor Sensor 070, One Universal Sensor 082, Data Brochures D 261, D 070, D 001, Application Brochure A 261.

Note: Carefully read the details of the *Sequence of Operation* to ensure that you have chosen the proper control for your application.

STEP TWO — MOUNTING THE BASE

Remove the control from its base by pressing down on the release clip in the wiring chamber and sliding the control away from it. The base is then mounted in accordance with the instructions in the Data Brochure D 001.

STEP THREE — ROUGH-IN WIRING

All electrical wiring terminates in the control base wiring chamber. The base has standard 7/8" (22 mm) knockouts which accept common wiring hardware and conduit fittings. Before removing the knockouts, check the wiring diagram and select those sections of the chamber with common voltages. Do not allow the wiring to cross between sections, as the wires will interfere with safety dividers which should be installed at a later time.

Power must not be applied to any of the wires during the rough-in wiring stage.

- Install the Outdoor Sensor 070 and Boiler Sensor 082 according to the instructions in the Data Brochure D 070, and run the wiring back to the control.
- Run wire from other system components (pump, boilers, etc.) to the control.
- Run wires from the 120 V (ac) power to the control. Use a clean power source to ensure proper operation. Multi-strand 16 AWG wire is recommended for all 120 V (ac) wiring due to its superior flexibility and ease of installation into the terminals.

STEP FOUR — ELECTRICAL CONNECTIONS TO THE CONTROL

The installer should test to confirm that no voltage is present at any of the wires. Push the control into the base and slide it down until it snaps firmly into place.

Powered Input Connections

120 V (ac) Power

Connect the 120 V (ac) power supply to the *Power L* and *Power N* terminals (5 and 6). This connection provides power to the microprocessor and display of the control. As well, this connection provides power to the *Boil Pmp* terminal (7) from the *Power L* terminal (5).

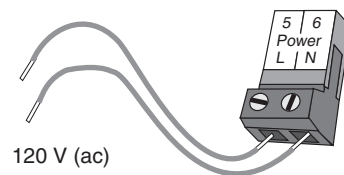

Boiler Demand

To generate a boiler demand, a voltage between 24 V (ac) and 240 V (ac) must be applied across the *Boiler Demand* terminals (1 and 2).

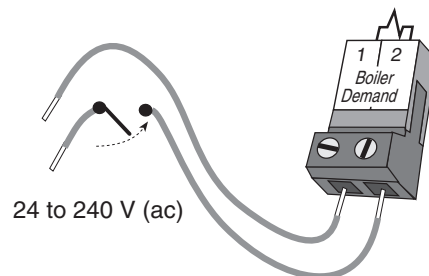

Setpoint Demand

To generate a setpoint demand, a voltage between 24 V (ac) and 240 V (ac) must be applied across the *Setpoint Demand* terminals (3 and 4).

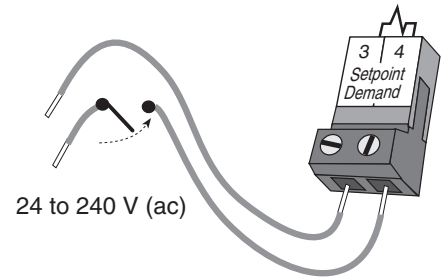

Output Connections

Boiler Pump Contact (*Boil Pmp*)

The boiler pump output terminal (7) on the 261 is a powered output. When the relay contact in the 261 closes, 120 V (ac) line (L) is provided to the *Boil Pmp* terminal (7) from the *Power L* terminal (5). To operate the boiler pump, connect one side of the boiler pump to terminal 7 and the second side of the pump circuit to the neutral (N) terminal 8.

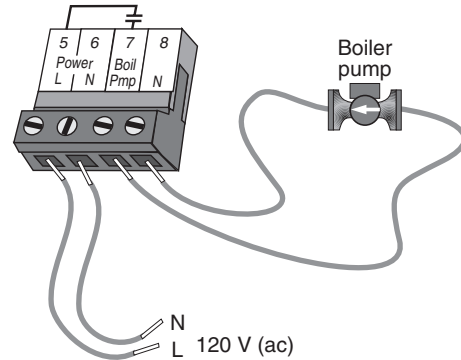

Boiler Contacts

The *Stage 1* and *Stage 2* terminals (9, 10 and 11, 12) are isolated outputs in the 261. There is no power available on these terminals from the control. These terminals are to be used as a switch to either make or break the boiler circuit. When the 261 requires the boiler(s) to fire, it closes the contact between terminals 9 and 10 and / or 11 and 12.

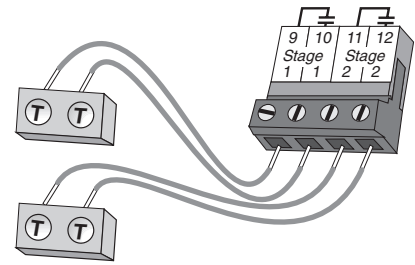

Sensor and Unpowered Input Connections

Do not apply power to these terminals as this will damage the control.

Outdoor Sensor

Connect the two wires from the Outdoor Sensor 070 to the *Out* and *Com* terminals (16 and 17). The outdoor sensor is used by the 261 to measure the outdoor air temperature.

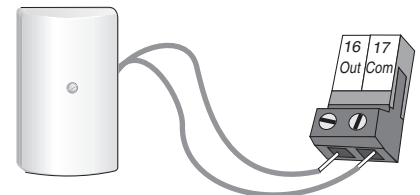

Boiler Sensor

Connect the two wires from the Boiler Sensor 082 to the *Boil* and *Com* terminals (15 and 17). The boiler sensor is used by the 261 to measure the supply (outlet) water temperature from the boiler.

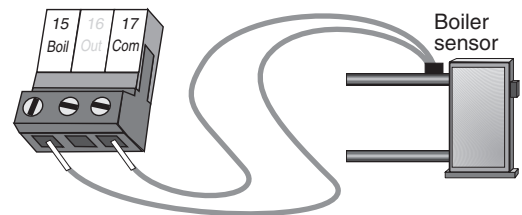

Unoccupied Switch

If an external timer (tekmar Timer 032) or switch is used, connect the two wires from the external switch to the *UnO Sw* and *Com* terminals (13 and 14). When these two terminals are shorted together, the control registers an unoccupied signal.

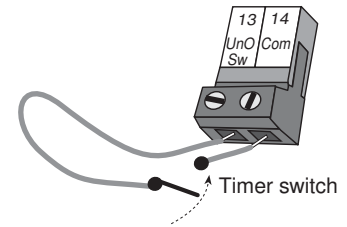

STEP FIVE — TESTING THE WIRING

Each terminal block **must be unplugged** from its header on the control before power is applied for testing. To remove a terminal block, pull it straight down from the control.

The following tests are to be performed using standard testing practices and procedures, and should only be carried out by properly trained and experienced persons.

A good quality electrical test meter, capable of reading from at least 0 - 300 V (ac) and at least 0 - 2,000,000 Ohms, is essential to properly test the wiring and sensors.

Test The Sensors

In order to test the sensors, the actual temperature at each sensor location must be measured. A good quality digital thermometer with a surface temperature probe is recommended for ease of use and accuracy. Where a digital thermometer is not available, a spare sensor can be strapped alongside the one to be tested, and the readings compared. Test the sensors according to the instructions in the Data Brochure D 070.

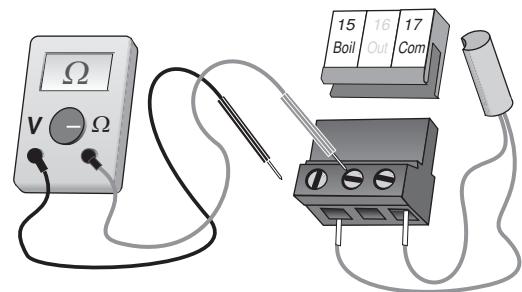

Test The Power Supply

Make sure exposed wires and bare terminals are not in contact with other wires or grounded surfaces. Turn on the power and measure the voltage between the *Power L* and *Power N* terminals (5 and 6) using an AC voltmeter. The reading should be between 108 and 132 V (ac).

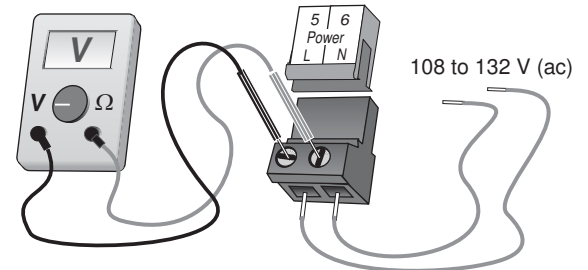

Test The Powered Inputs

Boiler Demand

Measure the voltage between the *Boiler Demand* terminals (1 and 2). When the boiler demand device calls for heat, you should measure between 20 and 260 V (ac) at the terminals. When the boiler demand device is off, you should measure less than 5 V (ac).

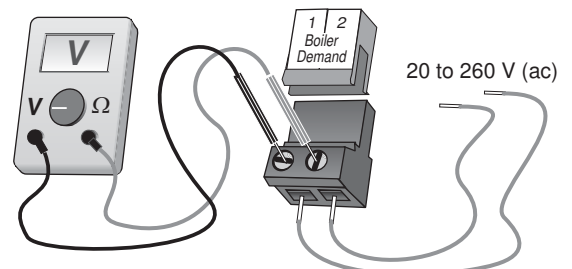

Setpoint Demand

If a setpoint demand is used, measure the voltage between the *Setpoint Demand* terminals (3 and 4). When the setpoint demand device calls for heat, you should measure between 20 and 260 V (ac) at the terminals. When the setpoint demand device is off, you should measure less than 5 V (ac).

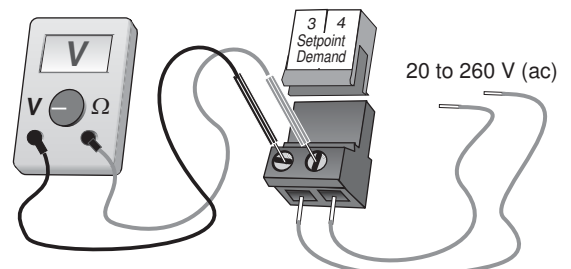

Test The Outputs

Boiler Pump (Boil Pmp)

If the boiler pump is connected to the *Boil Pmp* terminal (7), make sure power to the terminal block is off, and install a jumper between the *Power L* and the *Boil Pmp* terminals (5 and 7). Install a second jumper between *Power N* and *N* terminals (6 and 8). When power is applied to the *Power L* and *Power N* terminals (5 and 6), the boiler pump should start. If the pump does not turn on, check the wiring between terminal block and pump, and refer to any installation or troubleshooting information supplied with the pump. If the pump operates properly, disconnect the power and remove the jumpers.

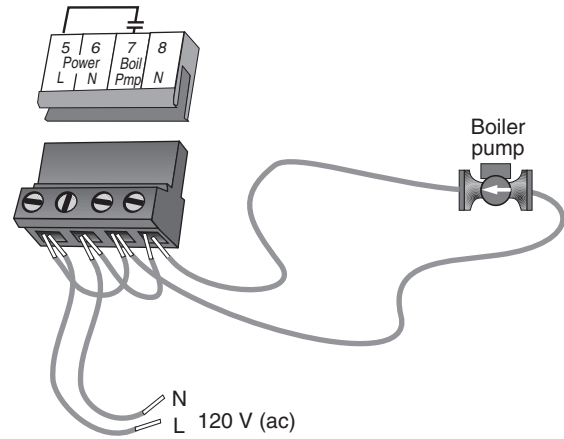

Stage 1 and 2

If the boiler circuit is connected to the *Stage 1* terminals (9 and 10) and / or *Stage 2* terminals (11 and 12), make sure power to the boiler circuit is off, and install a jumper between the terminals. When the boiler circuit is powered up, the boiler should fire. If the boiler does not turn on, refer to any installation or troubleshooting information supplied with the boiler. (The boiler may have a flow switch that prevents firing until the boiler pump is running). If the boiler operates properly, disconnect the power and remove the jumper.

Connecting The Control

Make sure all power to the devices and terminal blocks is off, and remove any remaining jumpers from the terminals.

Reconnect the terminal blocks to the control by carefully aligning them with their respective headers on the control, and then pushing the terminal blocks into the headers. The terminal blocks should snap firmly into place.

Install the supplied safety dividers between the unpowered sensor inputs and the powered or 120 V (ac) wiring chambers.

Apply power to the control. The operation of the control on power up is described in the *Sequence of Operation* section of this brochure.

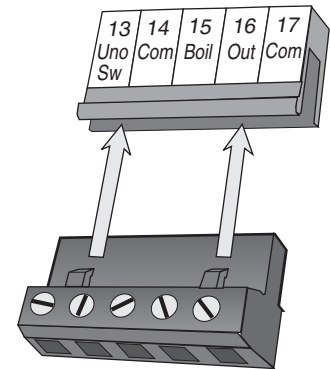

DIP Switch Settings

The DIP Switch settings on the control are very important and should be set to the appropriate settings prior to making any adjustments to the control through the user interface. The DIP switch settings change the items that are available to be viewed and / or adjusted in the user interface.

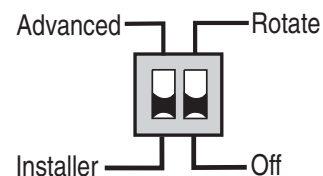

ADVANCED / INSTALLER

The *Advanced / Installer* DIP switch is used to select which items are available to be viewed and / or adjusted in the user interface.

ROTATE / OFF

The *Rotate / Off* DIP switch enables rotation of the boiler stages based on the *Equal Run Time Rotation* function. This function occurs whenever the lead boiler accumulates 48 hours more running time than the lag boiler. If a single Lo-Hi boiler is used, the DIP switch must be set to the *Off* position.

Quick Setup

To enter the installer programming mode, set the *Advanced / Installer* DIP switch to *Installer*.

Access the ADJUST menu by pressing and holding simultaneously for 1 second, the **Item**, ▲ and ▼ buttons (all three at same time). The display will now show the word ADJUST in the top right corner.

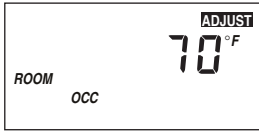

The ROOM OCC adjustment is the first item displayed. Use the ▲ or ▼ button to set the ROOM temperature. The ROOM OCC setting is set to the desired room air temperature during the occupied (Day) mode.

Note: To increase or decrease space temperature during the occupied (Day) mode, only adjust the ROOM OCC setting.



Press and release the **Item** button to advance to the ROOM UNOCC adjustment. Use the ▲ or ▼ button to set the desired temperature. The ROOM UNOCC setting is set to the desired room air temperature during the unoccupied (Night) mode.

Note: To increase or decrease space temperature during the unoccupied (Night) mode, only adjust the ROOM UNOCC setting.

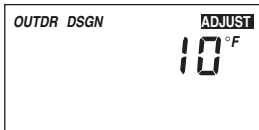

Press and release the **Item** button to advance to the OUTDR DSGN adjustment. Use the ▲ or ▼ button to set the outdoor design temperature. The OUTDR DSGN setting is set to the typical coldest temperature of the year.

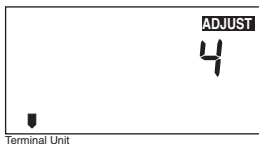

Press and release the **Item** button to advance to the *Terminal Unit* adjustment. Use the ▲ or ▼ button to select the desired terminal unit. The terminal unit number corresponds to the type of terminal that is being used. The table below lists the terminal units and their default values.

Terminal Unit	High Mass Radiant (1)	Low Mass Radiant (2)	Fancoil (3)	Fin-tube Convectore (4)	Radiator (5)	Baseboard (6)
BOIL DSGN	120°F (49°C)	140°F (60°C)	190°F (88°C)	180°F (82°C)	160°F (71°C)	150°F (66°C)
BOIL MAX	140°F (60°C)	160°F (71°C)	210°F (99°C)	200°F (93°C)	180°F (82°C)	170°F (77°C)
BOIL MIN	OFF	OFF	140°F (60°C)	140°F (60°C)	140°F (60°C)	140°F (60°C)



Press and release the **Item** button to advance to the *Setpoint* adjustment. Use the ▲ or ▼ button to set the desired temperature. The *Setpoint* setting is set to the desired setpoint supply temperature.



Press and release the **Item** button to advance to the units adjustment. Use the ▲ or ▼ button to set the scale to °F or °C.

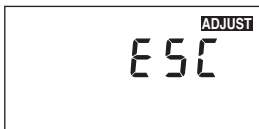

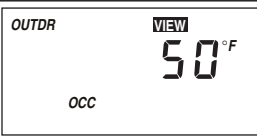
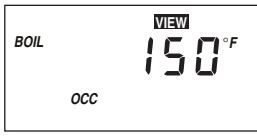
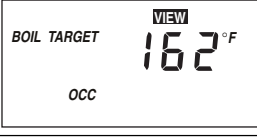

To exit the ADJUST menu, press and release the **Item** button to advance to the ESC item. Then either press the ▲ or ▼ button, or leave the buttons alone for 20 seconds.

View Menu (1 of 1)

Display	Section			Description	Range
	Installer	Advanced			
			●	Current outdoor air temperature as measured by the outdoor sensor. This is also the default display for the control.	-67 to 149°F (-55 to 65°C)
	B1 B3		●	Current boiler supply water temperature as measured by the boiler sensor.	14 to 266°F (-10 to 130°C)
	B1 B3 C		●	Target boiler supply is the temperature the control is currently trying to maintain at the boiler sensor.	---, 14 to 266°F (---, -10 to 130°C)

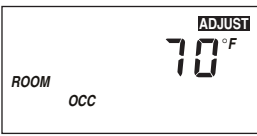
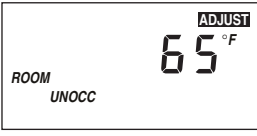
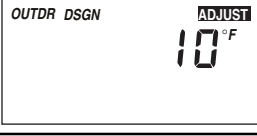
Adjust Menu (1 of 2)

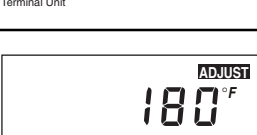
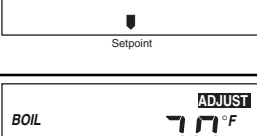
Display	Section			Description	Range	Actual Setting
	Installer	Advanced				
	B2		●	The desired room air temperature during an occupied (Day) period.	35 to 100°F (2 to 38°C)	
	B2		●	The desired room air temperature during an unoccupied (Night) period.	35 to 100°F (2 to 38°C)	
	B2		●	The design outdoor air temperature used in the heat loss calculation for the heating system.	-60 to 32°F (-51 to 0°C)	
	B2		●	The type of terminal units that are being used in the heating system.	1 (High Mass Radiant), 2 (Low Mass Radiant), 3 (Fancoil), 4 (Fin-tube Convector), 5 (Radiator), 6 (Baseboard)	
	C		●	Target setpoint temperature the control is currently trying to maintain at the boiler sensor.	OFF, 70 to 220°F (OFF, 21 to 104°C)	
	B3		●	The design indoor air temperature used in the heat loss calculation for the heating system.	35 to 100°F (2 to 38°C)	

Adjust Menu (2 of 2)

Display	Section	Installer	Advanced	Description	Range	Actual Setting
	B3	●		The design supply water temperature used in the heat loss calculation for the heating system.	70 to 220°F (21 to 104°C)	
	B3	●		The maximum boiler target supply water temperature.	120 to 225°F (49 to 107°C)	
	B3	●		The minimum temperature allowed for the boiler target temperature.	OFF, 80 to 180°F (OFF, 27 to 82°C)	
	B3	●		The time delay the control can expect between the time the boiler contact closes, and the burner fires.	0:00 to 3:00 min. (1 sec. increments)	
	B3	●		The differential that the control is to use when it is operating the boiler.	Ad, 2 to 42°F (Ad, -17 to 6°C)	
	B3	●		The system's warm weather shut down during the occupied (Day) period.	35 to 100°F, OFF (2 to 38°C, OFF)	
	B3	●		The system's warm weather shut down during the unoccupied (Night) period.	35 to 100°F, OFF (2 to 38 °C, OFF)	
		●	●	The units of measurement that all of the temperatures are to be displayed in the control.	°F, °C	
		●	●	This item exits the ADJUST menu by pressing either the ▲ or ▼ button.		

Testing the Control

The Boiler Control 261 has a built-in test routine which is used to test the main control functions. The 261 continually monitors the sensors, and displays an error message whenever a fault is found. See the following pages for a list of the 261's error messages and possible causes. When the **Test** button is pressed, the test light is turned on. The individual outputs and relays are tested in the following test sequence.

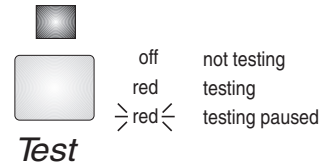

TEST SEQUENCE

Each step in the test sequence lasts 10 seconds.

During the test routine, the test sequence is paused by pressing the **Test** button. Only if there is a boiler demand can the control be paused in a step. If there is a setpoint demand, the control can only be paused during step 2 or step 3. If the **Test** button is not pressed again for 5 minutes while the test sequence is paused, the control exits the entire test routine. If the test sequence is paused, the **Test** button can be pressed again to advance to the next step. This can also be used to rapidly advance through the test sequence. To reach the desired step, repeatedly press and release the **Test** button until the appropriate device and segment in the display turn on.

Step 1 - The boiler pump (*Boil Pmp*) is turned on for 10 seconds.

Step 2 - The *Stage 1* contact is turned on for 10 seconds.

Step 3 - The *Stage 2* contact is turned on for 10 seconds. After 10 seconds, the *Stage 1*, *Stage 2*, and *Boil Pmp* contacts are shut off.

Step 4 - After the test sequence is completed, the control resumes its normal operation.

Troubleshooting

When troubleshooting any heating system, it is always a good idea to establish a set routine to follow. By following a consistent routine, many hours of potential headaches can be avoided. Below is an example of a sequence that can be used when diagnosing or troubleshooting problems in a hydronic heating system.

Establish the Problem

Establish the problem. Get as much information from the customer as possible about the problem. Is there too much heat, not enough heat, or no heat? Is the problem only in one particular zone or area of the building, or does the problem affect the entire system? Is this a consistent problem or only intermittent? How long has the problem existed for? This information is critical in correctly diagnosing the problem.

Understand the Sequence of Operation

Understand the sequence of operation of the system. If a particular zone is not receiving enough heat, which pumps or valves in the system must operate in order to deliver heat to the affected zone? If the zone is receiving too much heat, which pumps, valves, or check valves must operate in order to stop the delivery of heat?

Use the Test Routine

Press the **Test** button on the control, and follow the control through the test sequence as described in the Testing section. Pause the control as necessary to ensure that the correct device is operating as it should.

Sketch the Piping in the System

Sketch the piping of the system. This is a relatively simple step that tends to be overlooked, however, it can often save hours of time in troubleshooting a system. Note flow directions in the system paying close attention to the location of pumps, check valves, pressure bypass valves, and mixing valves. Ensure correct flow direction on all pumps. This is also a very useful step if additional assistance is required.

Document the Control

Document the control for future reference. Before making any adjustments to the control, note down all of the items that the control is currently displaying. This includes items such as error messages, current temperatures and settings, and which devices should be operating as indicated by the LCD. This information is an essential step if additional assistance is required to diagnose the problem.

Isolate the Problem

Isolate the problem between the control and the system. Now that the sequence of operation is known and the system is sketched, is the control operating the proper pumps and valves at the correct times? Is the control receiving the correct signals from the system as to when it should be operating? Are the proper items selected in the menus of the control for the device that is to be operated?

Test the Contacts Voltages & Sensors

Test the contacts, voltages and sensors. Using a multimeter, ensure that the control is receiving adequate voltage to the power terminals and the demand terminals as noted in the technical data. Use the multimeter to determine if the internal contacts on the control are opening and closing correctly. Follow the instructions in the Testing the Wiring section to simulate closed contacts on the terminal blocks as required. Test the sensors and their wiring as described in the sensor Data Brochures.

Error Messages

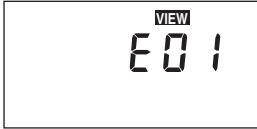

The control was unable to read a piece of information from its EEPROM. This error can be caused by a noisy power source. The control will load the factory defaults and stop operation until all the settings are verified.



The control is no longer able to read the outdoor sensor due to a short circuit. In this case the control assumes an outdoor temperature of 32°F (0°C) and continues operation. Locate and repair the problem as described in the Data Brochure D 070. To clear the error message from the control after the sensor has been repaired, press the **Item** button.



The control is no longer able to read the outdoor sensor due to an open circuit. In this case the control assumes an outdoor temperature of 32°F (0°C) and continues operation. Locate and repair the problem as described in the Data Brochure D 070. To clear the error message from the control after the sensor has been repaired, press the **Item** button.

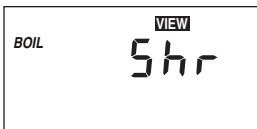

The control is no longer able to read the boiler sensor due to a short circuit. In this case, if the BOIL MIN adjustment is set to OFF, the control does not operate the stage contacts. If the BOIL MIN adjustment is not set to OFF, and a boiler demand is present, the *Stage 1* contact will operate for up to 10 minutes of a 20 minute cycle. Locate and repair the problem as described in the Data Brochure D 070. To clear the error message from the control after the sensor has been repaired, press the **Item** button.



The control is no longer able to read the boiler sensor due to an open circuit. In this case, if the BOIL MIN adjustment is set to OFF, the control does not operate the stage contacts. If the BOIL MIN adjustment is not set to OFF, and a boiler demand is present, the *Stage 1* contact will operate for up to 10 minutes of a 20 minute cycle. Locate and repair the problem as described in the Data Brochure D 070. To clear the error message from the control after the sensor has been repaired, press the **Item** button.

Technical Data

Boiler Control 261 Two Stage Boiler & Setpoint

Literature	— D 261, A 261's, D 001, D 070.
Control	— Microprocessor PID control; This is not a safety (limit) control .
Packaged weight	— 3.0 lb. (1340 g), Enclosure A, blue PVC plastic
Dimensions	— 6-5/8" H x 7-9/16" W x 2-13/16" D (170 x 193 x 72 mm)
Approvals	— CSA C US, CSA 22.2 No 24 and UL 873, meets class B: ICES & FCC Part 15.
Ambient conditions	— Indoor use only, 32 to 113°F (0 to 45°C), < 90% RH non-condensing.
Power supply	— 120 V (ac) ±10%, 50/60 Hz, 1300 VA
Relays	— 240 V (ac) 10 A 1/3 hp
Demands	— 20 to 260 V (ac) 2 VA
Sensors included	— NTC thermistor, 10 kΩ @ 77°F (25°C ±0.2°C) β=3892 Outdoor Sensor 070 and Universal Sensor 082.
Optional devices	— tekmar Timer 032.

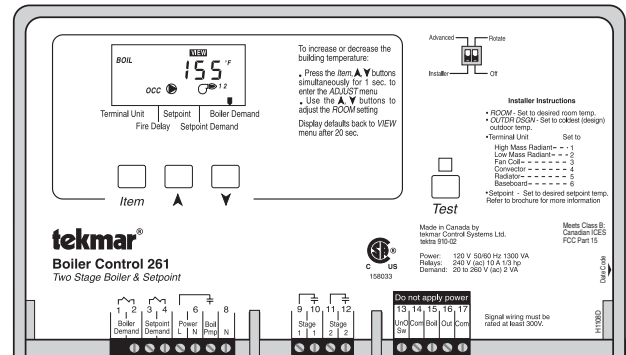

The installer must ensure that this control and its wiring are isolated and/or shielded from strong sources of electromagnetic noise. Conversely, this Class B digital apparatus complies with Part 15 of the FCC Rules and meets all requirements of the Canadian Interference-Causing Equipment Regulations. However, if this control does cause harmful interference to radio or television reception, which is determined by turning the control off and on, the user is encouraged to try to correct the interference by reorienting or relocating the receiving antenna, relocating the receiver with respect to this control, and/or connecting the control to a different circuit from that to which the receiver is connected.

Cet appareil numérique de la classe B respecte toutes les exigences du Règlement sur le matériel brouilleur du Canada.

Caution The nonmetallic enclosure does not provide grounding between conduit connections. Use grounding type bushings and jumper wires.

Attention Un boîtier nonmétallique n'assure pas la continuité électrique des conduits. Utiliser des manchons ou des fils de accord spécialement conçus pour la mise à la terre.

Limited Warranty and Product Return Procedure

Limited Warranty The liability of tekmar Control Systems Ltd. and tekmar Control Systems, Inc. ("tekmar") under this warranty is limited. The purchaser, by taking receipt of the tekmar product ("product"), acknowledges receipt of the terms of the warranty and acknowledges that it has read and understands same.

tekmar warrants each tekmar product against defects in workmanship and materials, if the product is installed and used in compliance with tekmar's instructions. The warranty period is for a period of twenty-four (24) months from the production date if the product is not installed during that period, or twelve (12) months from the documented date of installation if installed within twenty-four (24) months from the production date.

The liability of tekmar under this warranty shall be limited to, at tekmar's sole discretion: the cost of parts and labor provided by tekmar to repair defects in materials and/or workmanship of the defective product; or to the exchange of the defective product for a replacement product; or to the granting of credit limited to the original cost of the defective product, and such repair, exchange or credit shall be the sole remedy available from tekmar, and, without limiting the foregoing in any way, tekmar is not responsible, in contract, tort or strict product liability, for any other losses, costs, expenses, inconveniences, or damages, whether direct, indirect, special, secondary, incidental or consequential, arising from ownership or use of the product, or from defects in workmanship or materials, including any liability for fundamental breach of contract.

This warranty applies only to those products returned to tekmar during the warranty period. This warranty does not cover the cost of the parts or labor to remove or transport the defective product, or to reinstall the repaired or

replacement product. Returned products that are not defective are not covered by this warranty.

This warranty does not apply if the product has been damaged by negligence by persons other than tekmar, accident, fire, Act of God, abuse or misuse; or has been damaged by modifications, alterations or attachments made subsequent to purchase which have not been authorized by tekmar; or if the product was not installed in compliance with tekmar's instructions and the local codes and ordinances; or if due to defective installation of the product; or if the product was not used in compliance with tekmar's instructions.

This warranty is in lieu of all other warranties, express or implied, which the Governing Law (being the law of British Columbia) allows parties to contractually exclude, including, without limitation, warranties of merchantability, fitness for a particular purpose, durability or description of the product, its non-infringement of any relevant patents or trademarks, and its compliance with or non-violation of any applicable environmental, health or safety legislation; the term of any other warranty not hereby contractually excluded is limited such that it shall not extend beyond twenty-four (24) months from the production date, to the extent that such limitation is allowed by the Governing Law.

Product Return Procedure Products that are believed to have defects in workmanship or materials must be returned, together with a written description of the defect, to the tekmar representative for that territory. If the address of the representative is not known, please request it from tekmar at the telephone number listed below.

tekmar
Control Systems

tekmar Control Systems Ltd., Canada
tekmar Control Systems, Inc., U.S.A.
**Head Office: 5100 Silver Star Road
Vernon, B.C. Canada V1B 3K4
Tel. (250) 545-7749 Fax. (250) 545-0650
Web Site: www.tekmarcontrols.com**

