

BRINGING WARMTH TO LIFE

Danfoss

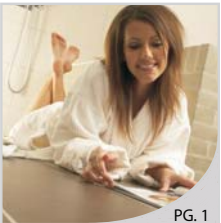

Electric Floor Heating



PG. 1

Electric Snow Melting



PG. 9

Roof & Gutter De-Icing



PG. 21

Pipe Freeze Protection



PG. 25

Thermal Storage



PG. 31

Danfoss Electric Heating Products
2012 CATALOG

A Brief History of...

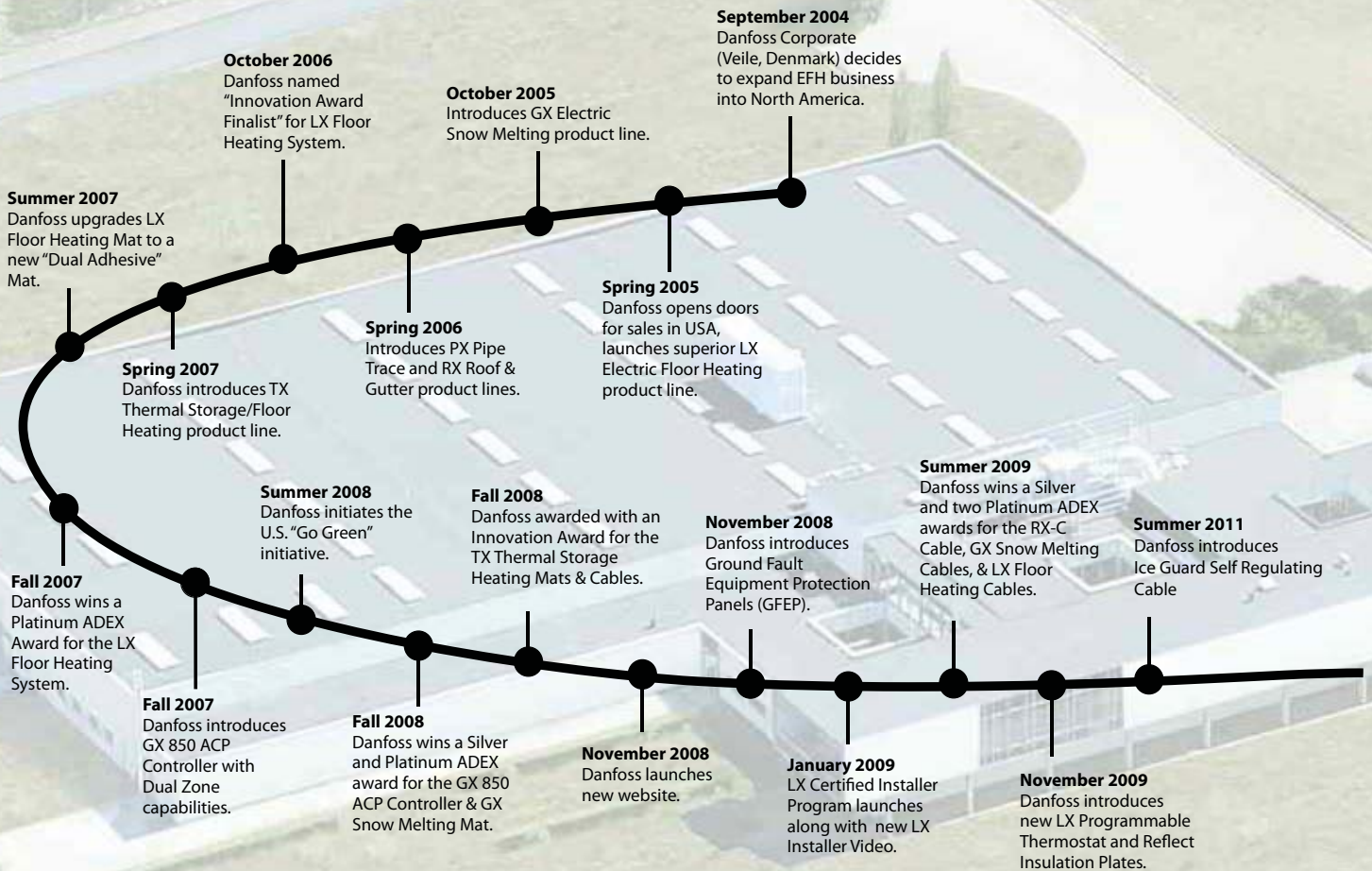

Contents:

LX ELECTRIC FLOOR HEATING

LX Mats	1
LX Cables	3
LX Thermostats	5
LX Accessories	6
Reflect	7

GX ELECTRIC SNOW MELTING

GX Mats	9
GX Cables	9
GX Controls	17
GX Accessories	20

RX ROOF & GUTTER DE-ICING

RX Kits (Residential)	21
RX-C Cable (Commercial)	22
RX Controls	23
RX Accessories	24

PX PIPE FREEZE PROTECTION

PX Self Regulating Cable	25
PX Controls	28
PX Accessories	28
Ice Guard Self Regulating Cable	29

TX THERMAL STORAGE & FLOOR HEATING

TX-FH Floor Heating	29
TX-SH Thermal Storage	30
TX Controls	31
TX Accessories	31

TECHNICAL INFORMATION	34
------------------------------------	----

GENERAL CONDITIONS OF SALE & WARRANTY	35
--	----

Danfoss LX Electric Floor Heating

Dual Self-Adhesive Mats

Danfoss LX Electric Floor Heating System (Self-Adhesive Mat & Thermostat) is an affordable luxury that brings warmth to life. It's a proven technology that is safe, reliable and energy efficient. The unique adhesive system SAVES 70% ON INSTALLATION TIME!

- Pre-applied heating cable means even heat every time
- Dual-adhesive backing, no fastening required
- Single point connection
- Twin conductor cable
- Eliminates EMF's (electromagnetic fields)
- Customize mat on the job site
- Minimal thickness-only adds 3/16" height to the floor
- Safety approved for wet locations
- Even heat every time
- No fastening required
- Genuine ten year non-prorated warranty, includes labor and materials

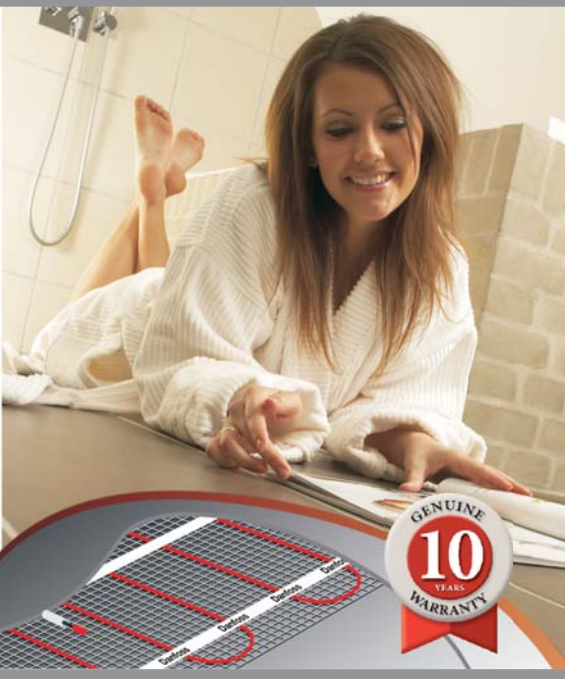

Easy to Install!



Unroll the self-adhesive mat onto the floor



Cut the mesh to turn
Never Cut the RED Cable



Install tile / floor coverings

Please visit our YouTube channel for step by step installation instructions:
www.youtube.com/danfossLX

Technical Data	LX Mats
Mat Construction:	Thermoplastic polymer coated fiberglass, self adhesive backing
Cable Construction:	Twin Conductor
Cable Diameter:	3/16" (4.8mm)
Rated Voltage:	120V, 208V, 240V
Max. Rated Temperature:	212°F (100°C)
Conductor Insulation:	Teflon™ FEP
Outer Insulation:	PVC



Installs in minutes!



Visit www.LXinstaller.com to learn about the Danfoss Installer Certification program

LX Thermostat

LX Floor Heating Mats

Please take into consideration the locations of sinks, tubs, toilets and objects on the floor when measuring the floor area

Danfoss LX Electric Floor Heating

Typical Applications

PLYWOOD SUBFLOOR

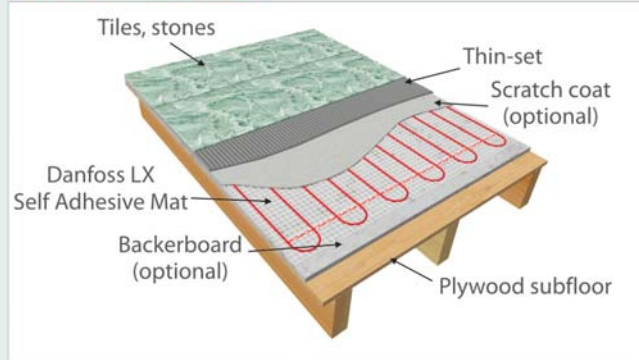

CONCRETE SUBFLOOR

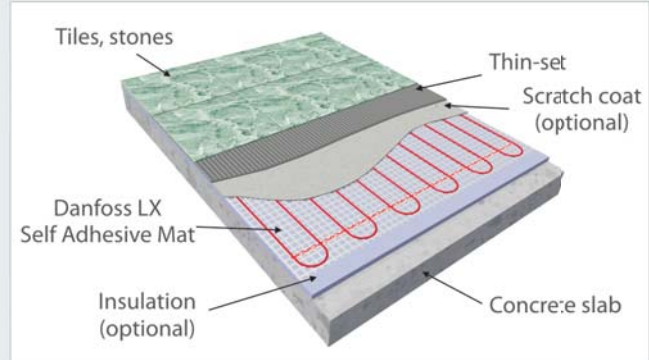

ENGINEERED WOOD, LAMINATE OR CARPET

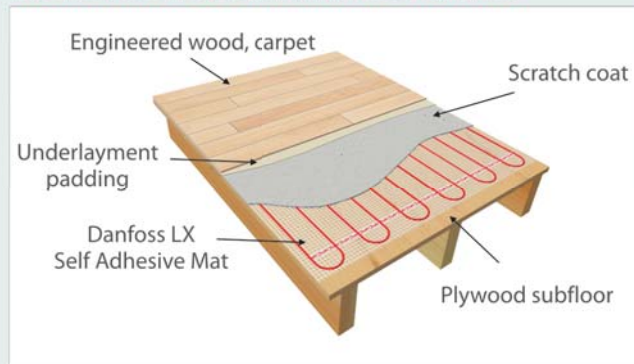

Ordering Information		LX Mats		120V, 240V		
Part No.		Length (feet)	Coverage (sq.ft.)	Amps		Watts (12W/sq.ft.)
120V	240V			120V	240V	
088L3150	-	5.0	10	1.0	-	120
088L3151	-	7.5	15	1.5	-	180
088L3152	-	10.0	20	2.0	-	240
088L3153	-	12.5	25	2.5	-	300
088L3154	-	15.0	30	3.0	-	360
088L3155	088L3175	17.5	35	3.5	1.8	420
088L3156	088L3176	20.0	40	4.0	2.0	480
088L3158	088L3177	25.0	50	4.9	2.5	600
088L3160	088L3178	30.0	60	6.0	3.0	720
-	088L3179	35.0	70	-	3.5	850
-	088L3180	40.0	80	-	4.0	960
-	088L3181	45.0	90	-	4.5	1,080
-	088L3182	50.0	100	-	5.0	1,200
-	088L3183	55.0	110	-	5.5	1,320
-	088L3184	60.0	120	-	6.0	1,440
-	088L3185	72.5	145	-	7.3	1,740



Notes:

- All mats are 2 feet in width
- Power leads are 10 feet in length
- Watt output of the 240V mats are reduced by 25% when operated at 208V (9W/sq.ft.)
- Floor sensor conduit is included
- Contactor or Power Module is required for loads exceeding 15 amps on a single thermostat (see pg.6 for details)

Controls - See PG. 5
Accessories- See PG. 6

Danfoss LX Electric Floor Heating

Electric Floor Heating Cables

Danfoss LX Electric Floor Heating Cable Systems combine the highest comfort levels with the maximum energy efficiency. Our Electric Floor Heating Cable Systems offer the following features:

- Single point connection
- Twin conductor cable
- Eliminates EMF's (electromagnetic fields)
- Safety approved for wet locations
- Flexible installation
- Durable construction
- Genuine ten year non-prorated warranty, includes labor and materials

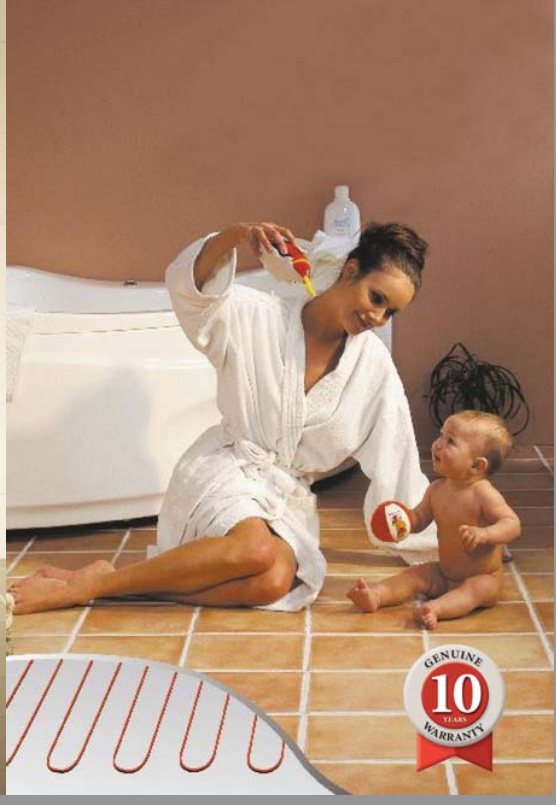

Installation



Attach the Danfoss cable strapping to the sub floor (3' - 4' apart)



Place the LX cable in the tabs (3" standard spacing)

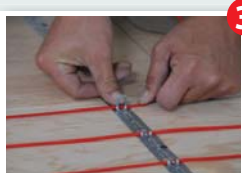

Clip the LX Cable in place

Technical Data	LX Cables
Cable Construction:	Twin Conductor
Cable Diameter:	3/16" (4.8mm)
Rated Voltage:	120V, 208V, 240V
Max. Rated temperature:	212°F (100°C)
Conductor Insulation:	Teflon™ FEP
Outer Insulation:	PVC



Flexible installation!



Please visit our YouTube channel for step by step installation instructions:
www.youtube.com/danfossLX

Please take into consideration the locations of sinks, tubs, toilets and objects on the floor when measuring the floor area

Danfoss LX Electric Floor Heating

Electric Floor Heating Cables

Ordering Information		LX Cables			120V		
Part No.	Length (feet)	Approximate Heat Coverage (sq.ft.)			Amps	Watts (3W/ft.)	LX Strapping included: feet (m)
		2" spacing	Standard 3" spacing	4" spacing			
088L3140	40	5	10	15	1.0	120	15 (4.6)
088L3141	60	10	15	20	1.5	180	15 (4.6)
088L3142	80	15	20	25	2.0	240	30 (9.1)
088L3143	120	20	30	40	3.0	360	30 (9.1)
088L3144	160	25	40	55	4.0	480	75 (22.9)
088L3145	200	35	50	65	5.0	600	75 (22.9)
088L3146	240	40	60	80	6.3	750	75 (22.9)
088L3147	280	45	70	95	7.2	860	75 (22.9)
088L3148	315	50	80	105	8.0	960	75 (22.9)



Ordering Information		LX Cables			240V		
Part No.	Length (feet)	Approximate Heat Coverage (sq.ft.)			Amps	Watts (3W/ft.)	LX Strapping included: feet (m)
		2" spacing	Standard 3" spacing	4" spacing			
088L3080	80	15	20	25	1.0	245	30 (9.1)
088L3081	120	20	30	40	1.5	365	30 (9.1)
088L3082	160	25	40	55	2.0	480	75 (22.9)
088L3083	200	35	50	65	2.5	605	75 (22.9)
088L3084	240	40	60	80	3.0	725	75 (22.9)
088L3085	280	45	70	95	3.5	840	75 (22.9)
088L3086	320	55	80	105	4.0	965	75 (22.9)
088L3087	360	60	90	120	4.5	1080	105 (32.0)
088L3088	400	65	100	135	5.0	1200	105 (32.0)
088L3089	440	75	110	145	5.5	1330	150 (45.7)
088L3090	480	80	120	160	6.5	1445	150 (45.7)
088L3091	570	95	140	190	7.1	1710	150 (45.7)
088L3092	630	105	160	210	8.0	1915	150 (45.7)

Notes:

- Cable strapping is supplied with product. Additional cable strapping can be ordered separately (See pg. 6)
- 2" centers provide 18W/sq.ft.
- 3" centers provide 12W/sq.ft.
- 4" centers provide 9W/sq.ft.
- Watt output of the 240V cable is reduced by 25% when operated at 208V (approximately 2W/ft.)
- Power leads are 10 feet in length
- Floor sensor conduit is not included (Part # 19809099)
- Contactor or Power Module is required for loads exceeding 15 amps on a single thermostat (See Pg. 6)

**Controls - See PG. 5
Accessories- See PG. 6**

Danfoss LX Electric Floor Heating



Non-Programmable



Electric Floor Heating Thermostats

The Danfoss LX Thermostat raises the bar for aesthetic appeal while offering industry-leading functionality. The LX electronic thermostat offers optimum comfort and numerous user friendly features:

- Large backlit display for easy programming
- Includes Class-A GFCI for safety (approved for wet locations)
- Simple to program with intuitive on-screen menus
- Monitor energy consumption
- Dual voltage capability (can operate at either 120V or 240V)
- Four event, seven day ENERGY SAVINGS programming
- Easily upgrade older model LX thermostats

Technical Data	LX Thermostats
Temperature Range:	40°F to 104°F 5°C to 40°C
GFCI:	Class A (5mA trip level)
Supply Voltage:	120V - 240V max., 50/60Hz
Max. Load:	15A max (resistive load)
Max. Power:	1,800W at 120VAC 3,600W at 240VAC
Programmable Thermostat Dimensions (HxWxD):	4.80" x 3.00" x 1.00" 123mm x 74mm x 25mm
Manual Thermostat Dimensions (HxWxD):	4.65" x 2.90" x 1.90" 118mm x 74mm x 48mm



Ordering Information	LX Thermostats	120V - 240V
Part No.	Description	
088L5130	LX Programmable Thermostat with Floor Sensor	
088L5132	LX Programmable Thermostat with Air Sensor (and floor temperature limiter)	
088L5133	LX Non-Programmable Thermostat with Floor Sensor	

Note: All Thermostats include a Floor Sensor with a 10 foot lead.

Danfoss LX Electric Floor Heating

LX Power Module

The LX Series Power Module makes it easy to connect more heating mats or cables to the same thermostat without the need for contactor panels.

- An easy control solution for large areas
- Receives on/off command from the main thermostat
- Each Power Module adds 15A switching capability
- Up to 5 Power Modules can be added to the thermostat
- Includes Class-A GFCI for safety (approved for wet locations)
- For use with Programmable LX thermostat only



Ordering Information		Power Module / Contactor		
Part No.	Description	Max. Amps	Coil Voltage	No. of Contactors
088L5135	Power Module with GFCI	15	N/A	1
088L3450	Single Contactor, 600V max.	40	120	1
088L3451	Single Contactor, 600V max.	40	208-240	1

Contactor or LX Power Module is required for loads exceeding 15 Amps on a single thermostat
All contactors are complete with NEMA 1 enclosure

Cable Strapping



Part # 088L1050/51

Little Buzzer



Part # 088L0028

Electric Floor Heating Accessories

Ordering Information		LX Accessories
Part No.	Description	
088L1050	Cable Strapping (15 ft/4.5 m)	
088L1054	Cable Strapping (75 ft/22.9 m)	
088L3008	Replacement floor sensor for LX Thermostat	
088L0014	LX Repair Kit (includes: crimp connectors, repair wire, heat shrink, tubes)	
19809099	Sensor Conduit (8 ft)	
088L0028	Little Buzzer (continuity alarm)	

Sensor Conduit



Part # 19809099

LX Repair Kit



Part # 088L0014

Floor Sensor



Part # 088L3008

Little Buzzer - Continuity Alarm (088L0028)

Simplify your installation process by using the Little Buzzer by Danfoss. The Little Buzzer is designed to monitor Danfoss Heating Mats or Cables during installation and will sound an alarm if the heating element is cut or damaged. This allows an easy repair before the floor covering is laid. The Little Buzzer is battery powered with a set of batteries included.

NOTE: A continuity alarm does not replace the need for measuring and verifying the Ohm resistance three times throughout the installation process. Failure to do so may result in voiding the warranty.

Danfoss Reflect Electric Floor Heating

Reflect Insulation Plates

Reflect Insulation Plates are a revolutionary designed product that eliminates the need for a top coat on floating floors. When combined with Danfoss LX Heating Cables, Reflect provides the perfect solution for quick and easy installation of electric floor heating under engineered wood or laminate floors. The combination of an insulating sub floor and a heat conducting surface ensures optimum heat is delivered up through the floor.

- Best solution available for heating under laminate and engineered wood flooring
- Saves time, no mixing of thin set or mud required
- Reflective plates heat quickly and evenly for maximum comfort
- High R-value insulation helps to reduce energy consumption
- Ideal for concrete floors and basement renovations

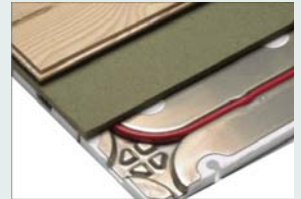

1

Lay out Reflect Plates



2

Clip plates together, cut plates with jigsaw if necessary



3

Install heating cable in grooves, pressing gently

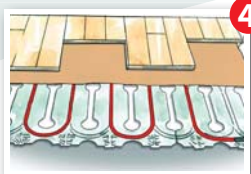

4

Lay underlayment padding and then the floor covering

Technical Data	Reflect
Construction:	Expanded polystyrene with aluminum surface
Size:	19.75" x 39.50" (501mm x 1003mm)
Height:	0.5" (12.7mm)
Insulation:	Expanded polystyrene (EPS)
Deformation Strength:	734 lbs/sq.ft.
R-Value:	1.5
Groove Spacing:	4" (center to center)

Ordering Information	Reflect	No. of plates (per box)	Approx. sq.ft. (per box)
Part No.	Description		
088L0095	Reflect Insulation Plates	10	50
088L0096	Reflect Insulation Plates	4	20

LX Cable sold separately - see page 8 for Typical Selection Chart

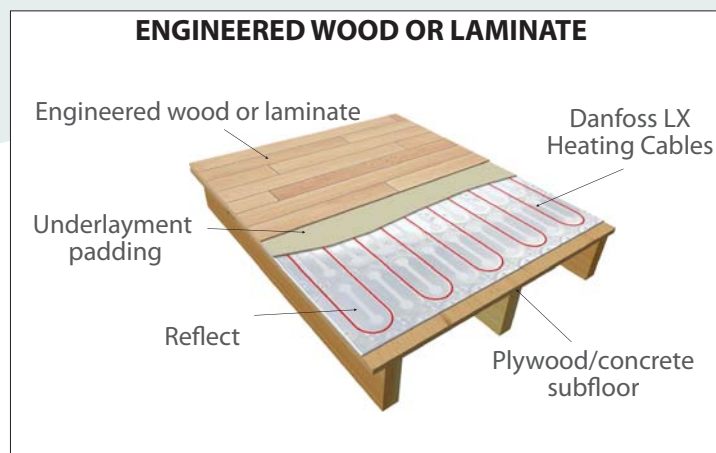

Danfoss *Reflect* Electric Floor Heating

Typical Selection Chart

Ordering Information	LX Cable & Reflect	120V
Coverage (sq.ft.)*	LX Cable	Reflect Required
15	088L3140	1 x 088L0096
20	088L3141	1 x 088L0096
25	088L8142	2 x 088L0096
40	088L3143	2 x 088L0096
55	088L3144	1 x 088L0095
65	088L3145	1 x 088L0095 + 1 x 088L0096
80	088L3146	4 x 088L0096
95	088L3147	1 x 088L0095 + 2 x 088L0096
105	088L3148	2 x 088L0095

*Based on 4" center to center spacing

All plates are approximately 20" (508mm) in width

LX Cable sold separately - see page 4 for ordering information

Ordering information	LX Cable & Reflect	240V
Coverage (sq.ft.)*	LX Cable	Reflect Required
25	088L3080	2 x 088L0096
40	088L3081	2 x 088L0096
55	088L3082	1 x 088L0095
65	088L3083	1 x 088L0095 + 1 x 088L0096
80	088L3084	4 x 088L0096
95	088L3085	1 x 088L0095 + 2 x 088L0096
105	088L3086	2 x 088L0095
120	088L3087	2 x 088L0095 + 1 x 088L0096
135	088L3088	1 x 088L0095 + 4 x 088L0096
145	088L3089	2 x 088L0095 + 2 x 088L0096
160	088L3090	3 x 088L0095
190	088L3091	2 x 088L0095 + 4 x 088L0096
210	088L3092	4 x 088L0095

*Based on 4" center to center spacing

All plates are approximately 20" (508mm) in width

LX Cable sold separately - see page 4 for ordering information

Danfoss GX Electric Snow Melting

Electric Snow Melting Mats & Cables

Installing a Danfoss GX Snow Melting System provides a permanent solution to the problems caused by cold weather. The GX Snow Melting System is an on demand system that will provide you with improved safety by providing instantaneous relief from snow build up and ice forming. There is no need for costly snow melting chemicals that can damage interior and exterior flooring finishes. The GX Snow Melting System allows you to improve your bottom line by reducing the labor and machinery costs associated with clearing snow and ice.

- Twin conductor cables
- Single point connection
- Flexible and simple to install
- Durable construction
- Operates silently, efficiently and safely
- Ideal for driveways, parking lots, sidewalks, stairs, ramps, bridges and many other applications
- For use in concrete, asphalt and under pavers
- Eliminates EMF's (electromagnetic fields)
- GX Heating Mats significantly reduce installation time and labor
- Genuine ten year non-prorated warranty, includes labor and materials



Installation



Prepare the area. Insulation below and on the sides of the slab are recommended

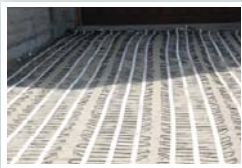

Lay out the GX Mats or Cables



Install ground sensors at opposite ends of the area

Technical Data	GX Mats & Cables
Cable Construction:	Twin Conductor
Cable Diameter:	1/4" (6mm)
Rated Voltage:	208, 240, 277, 347, 480, 600V
Max. Rated Temperature:	220°F (105°C)
Conductor Insulation:	Teflon™ FEP
Outer Insulation:	PVC



SYSTEM COMPONENTS

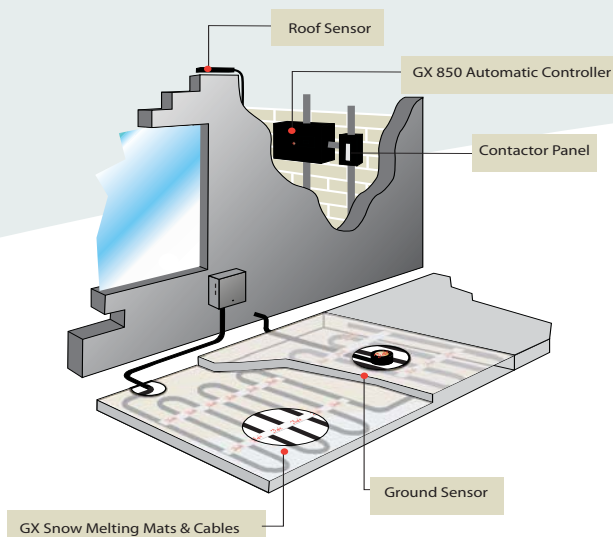

Danfoss GX Electric Snow Melting

Typical Applications

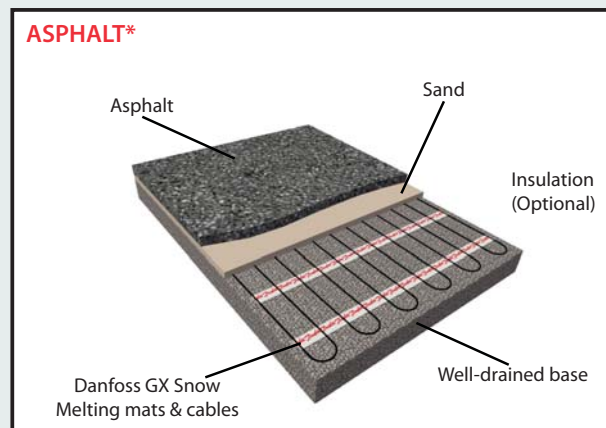
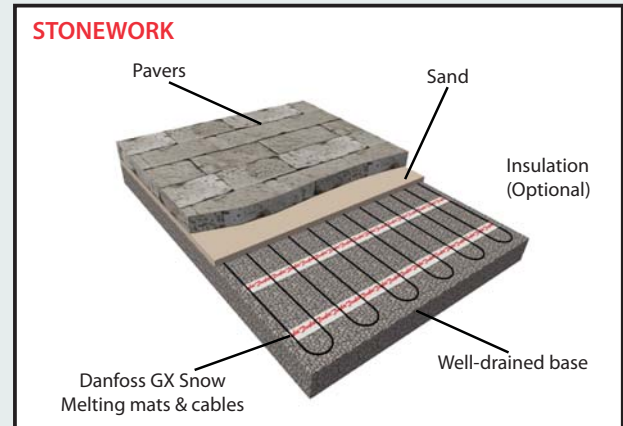
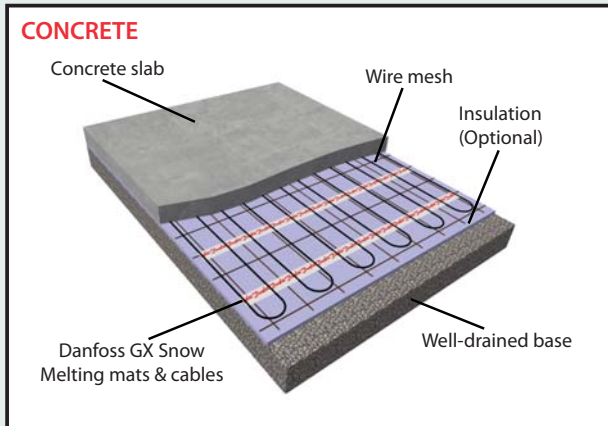

***Notes:**

- Cables can be embedded in sand or concrete (1.0" / 25.4mm) for extra protection
- If using sand or concrete with asphalt, allow asphalt to cool to 265° F (130° C) before pouring directly on mats/cables
- If using without sand or concrete allow asphalt to cool to 220°F (105° C) before pouring directly on mats/cables

DRIVEWAY

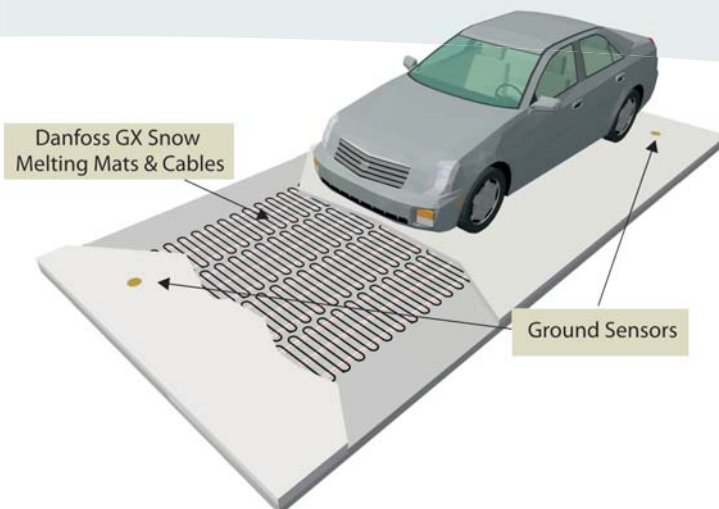

STAIRS

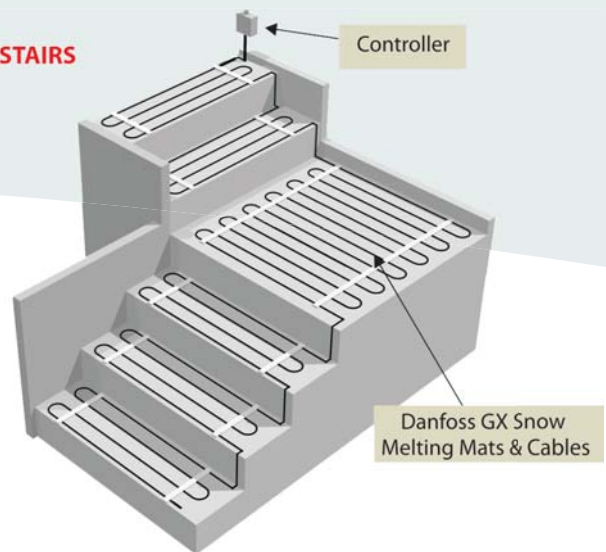

Danfoss GX

Electric Snow Melting

Electric Snow Melting Mats



Ordering Information		GX Mats		208V
Part No.	Length (feet)	Coverage (sq.ft.)	Watts (50W/sq.ft.)	Amps
088L3222	6.5	15	640	3.1
088L3223	10.0	20	1100	5.3
088L3224	12.5	25	1280	6.2
088L3225	15.0	30	1550	7.4
088L3226	17.5	35	1730	8.3
088L3227	20.0	40	1900	9.2
088L3228	22.5	45	2100	10.1
088L3229	25.0	50	2400	11.5
088L3230	30.0	60	3050	14.7
088L3231	35.0	70	3400	16.4
088L3232	40.0	80	3800	18.3
088L3233	45.0	90	4230	20.3
088L3234	50.0	100	5000	24.1

Ordering Information		GX Mats		240V
Part No.	Length (feet)	Coverage (sq.ft.)	Watts (50W/sq.ft.)	Amps
088L3201	7.5	15	750	3.1
088L3202	10.0	20	1000	4.2
088L3203	12.5	25	1250	5.2
088L3204	15.0	30	1500	6.3
088L3205	17.5	35	1750	7.3
088L3206	20.0	40	2000	8.3
088L3207	22.5	45	2250	9.4
088L3208	25.0	50	2500	10.4
088L3209	30.0	60	3000	12.5
088L3210	35.0	70	3500	14.6
088L3211	40.0	80	4000	16.7
088L3212	45.0	90	4500	18.8
088L3213	50.0	100	5000	20.8
088L3214	57.5	115	5750	24.0
088L3215	65.0	130	6500	27.1

Notes:

- All mats are 2 feet wide
- Power leads are 20 feet in length
- Watt output of the 240V mat is reduced by 25% when operated at 208V (Approximately 37.5 W/sq.ft.)

Controls - See PG. 17
Accessories- See PG. 20

Danfoss GX

Electric Snow Melting

Electric Snow Melting Mats

Ordering Information		GX Mats		240V (37W/sq.ft)	
Part No.	Length (feet)	Coverage (sq.ft.)	Watts (37W/sq.ft.)	Amps	
088L3300	16.5	35	1235	5.1	
088L3301	20.0	40	1480	6.2	
088L3302	45.0	90	3495	14.6	
088L3303	60.0	120	4505	18.8	
088L3304	77.5	155	5715	23.8	

Ordering Information		GX Mats		277V	
Part No.	Length (feet)	Coverage (sq.ft.)	Watts (50W/sq.ft.)	Amps	
088L3250	15.0	30	1370	4.9	
088L3251	17.5	35	1690	6.1	
088L3252	20.0	40	2080	7.5	
088L3253	22.5	45	2350	8.5	
088L3254	25.0	50	2675	9.7	
088L3255	30.0	60	2800	10.1	
088L3256	35.0	70	3440	12.4	
088L3257	40.0	80	4080	14.7	
088L3258	45.0	90	4680	16.9	
088L3259	52.5	105	5100	18.4	
088L3260	57.5	115	5850	21.1	



Notes:

- All mats are 2 feet wide
- Power leads are 20 feet in length
- Watt output of the 277V mat is reduced by 25% when operated at 240V (Approximately 37.5 W/ sq.ft.)

Controls - See PG. 17
Accessories- See PG. 20

Danfoss GX

Electric Snow Melting

Electric Snow Melting Mats



Ordering Information		GX Mats		480V
Part No.	Length (feet)	Coverage (sq.ft.)	Watts (50W/sq.ft.)	Amps
088L3270	10.0	20	1000	2.1
088L3271	15.0	30	1500	3.1
088L3272	20.0	40	2000	4.2
088L3273	25.0	50	2500	5.2
088L3274	30.0	60	3000	6.3
088L3275	35.0	70	3500	7.3
088L3276	40.0	80	4000	8.3
088L3277	45.0	90	4500	9.4
088L3278	50.0	100	5000	10.4
088L3279	60.0	120	6000	12.5
088L3280	70.0	140	7000	14.6
088L3281	80.0	160	8000	16.7

Ordering Information		GX Mats		600V
Part No.	Length (feet)	Coverage (sq.ft.)	Watts (50W/sq.ft.)	Amps
088L3290	12.5	25	1250	2.1
088L3291	17.5	35	1845	3.1
088L3292	25.0	50	2485	4.1
088L3293	30.0	60	3075	5.1
088L3294	37.5	75	3715	6.2
088L3295	45.0	90	4455	7.4
088L3296	50.0	100	5050	8.4
088L3297	57.5	115	5685	9.5
088L3298	62.5	125	6280	10.5
088L3299	75.0	150	7505	12.5

Notes:

- All mats are 2 feet wide
- Power leads are 20 feet in length
- Watt output of the 600V mat is reduced by 35% when operated at 480V (Approximately 32.5 W/sq.ft.)

Controls - See PG. 17
Accessories- See PG. 20

Danfoss GX Electric Snow Melting

Electric Snow Melting Cables

Ordering Information		GX Cables		208V	
Part No.	Length (feet)	Approximate Heat Coverage (sq.ft.)		Watts (12W/ft.)	Amps
		Standard 3" Spacing	4" Spacing		
088L3120	35	5	10	420	2.0
088L3121	50	10	15	600	2.9
088L3122	70	15	25	840	4.0
088L3123	85	20	30	1020	4.9
088L3124	105	25	35	1260	6.1
088L3125	125	30	45	1500	7.2
088L3126	145	35	50	1740	8.4
088L3127	160	40	55	1920	9.2
088L3128	180	45	60	2160	10.4
088L3129	210	50	70	2520	12.1
088L3130	245	60	85	2940	14.1
088L3131	280	65	95	3360	16.2
088L3132	320	75	110	3810	18.5
088L3133	355	85	120	4260	20.5
088L3134	410	100	140	4920	23.7
088L3135	460	110	160	5520	26.5



Ordering Information		GX Cables		240V	
Part No.	Length (feet)	Approximate Heat Coverage (sq.ft.)		Watts (12W/ft.)	Amps
		Standard 3" Spacing	4" Spacing		
088L3100	40	10	15	480	2.0
088L3101	60	15	20	720	3.0
088L3102	80	20	25	960	4.0
088L3103	100	25	35	1200	5.0
088L3104	120	30	40	1440	6.0
088L3105	145	35	50	1740	7.3
088L3106	165	40	55	1980	8.3
088L3107	185	45	65	2220	9.3
088L3108	205	50	70	2460	10.3
088L3109	245	60	85	2940	12.3
088L3110	285	70	100	3420	14.3
088L3111	325	80	110	3900	16.3
088L3112	370	90	125	4440	18.5
088L3113	410	105	140	4920	20.5
088L3114	475	120	165	5700	23.8
088L3115	535	135	185	6420	26.8

Notes:

- Power leads are 20 feet in length
- 3" centers provides 50W/sq.ft.
- 4" centers provides 35W/sq.ft.
- Watt output of the 240V mat is reduced by 25% when operated at 208V (Approximately 9 W/ft.)

**Controls - See PG. 17
Accessories- See PG. 20**

Danfoss GX

Electric Snow Melting

Electric Snow Melting Cables



Ordering Information		GX Cables		277V	
Part No.	Length (feet)	Approximate Heat Coverage (sq.ft.)		Watts (12W/ft.)	Amps
		Standard 3" Spacing	4" Spacing		
088L3060	50	10	15	540	1.9
088L3061	70	15	25	850	3.1
088L3062	95	20	30	1120	4.0
088L3063	115	25	40	1440	5.2
088L3064	140	35	50	1700	6.1
088L3065	170	40	60	2015	7.3
088L3066	190	45	65	2340	8.4
088L3067	215	50	75	2600	9.4
088L3068	240	55	80	2860	10.3
088L3069	285	65	95	3450	12.4
088L3070	330	80	115	4030	14.5
088L3071	375	90	125	4610	16.6
088L3072	425	100	145	5140	18.6
088L3073	475	115	160	5770	20.8
088L3074	545	130	185	6615	23.8

Notes:

- Power leads are 20 feet in length
- 3" centers provides 50W/sq.ft.
- 4" centers provides 35W/sq.ft.
- Watt output of the 277V mat is reduced by 25% when operated at 240V (Approximately 9 W/ft.)

Controls - See PG. 17
Accessories- See PG. 20

Danfoss GX

Electric Snow Melting

Electric Snow Melting Cables

Ordering Information		GX Cables		480V	
Part No.	Length (feet)	Approximate Heat Coverage (sq.ft.)		Watts (12W/ft.)	Amps
		Standard 3" Spacing	4" Spacing		
088L3640	80	20	25	995	2.1
088L3644	200	50	70	2460	5.1
088L3646	330	85	110	4030	8.4
088L3648	490	125	160	5990	12.5
088L3650	735	185	240	8650	18.6
088L3652	820	205	270	10010	20.9
088L3654	940	235	310	11475	23.9



Ordering Information		GX Cables		600V	
Part No.	Length (feet)	Approximate Heat Coverage (sq.ft.)		Watts (12W/ft.)	Amps
		Standard 3" Spacing	4" Spacing		
088L3620	100	25	35	1240	2.1
088L3621	150	40	50	1855	3.1
088L3622	250	65	85	3080	5.1
088L3623	300	75	100	3690	6.2
088L3624	360	90	120	4425	7.4
088L3625	415	105	135	5040	8.4
088L3626	465	115	155	5650	9.4
088L3627	515	130	170	6265	10.4
088L3628	615	155	205	7485	12.5
088L3629	714	175	235	8705	14.5

Notes:

- Power leads are 20 feet in length
- 3" centers provides 50W/sq.ft.
- 4" centers provides 35W/sq.ft.
- Watt output of the 600V mat is reduced by 35% when operated at 480V (Approximately 7.5W/ft.)

Controls - See PG. 17
Accessories- See PG. 20

Danfoss GX Electric Snow Melting

Electric Snow Melt Controllers

GX 850 Dual Zone Automatic Control Panel

The AWARD WINNING Danfoss GX Dual Zone Automatic Control Panel (ACP) is the most optimal solution for keeping any area free of ice and snow. The GX 850 acts on information received from sensors which register both temperature and moisture, then calculates the information ensuring that the heat will only be turned on when snow and/or ice is present. The result is optimal performance with maximum energy savings and minimum operating costs.

GX 850 ACP



Part # 088L3411

Ground Sensors



Part # 088L3051

Roof Sensor



Part # 088L3052

- User interface allows total control of snow melting system set points
- Set to maximum melting, or maximum energy savings or anywhere in between
- Dual zone feature allows for energy savings and lower amperage draw
- Digital sensors provide precise feedback on snow and ice conditions
- Fault finding program detects and alarms on faults
- Can be field upgraded to take advantage of new features
- Integrate four separate sensors
- Two year warranty



Technical Data	GX850 ACP
Control Voltage:	600V max
Max. Heating Load:	50A
Max. Ambient Temperature:	15°F to 100°F (-10°C to +40°C)
Enclosure Type:	NEMA 4X
Mounting:	Wall mounted, indoors
Dimensions (H x W x D):	10.5" x 13.5" x 7.5" (267mm x 343mm x 191mm)

Requires ground and / or roof sensors

Systems larger than 50A will require the use of timer / contactor panels used in conjunction with the GX850 (see page 18)



DUAL ZONE EXAMPLES

Roof & Ground Zones

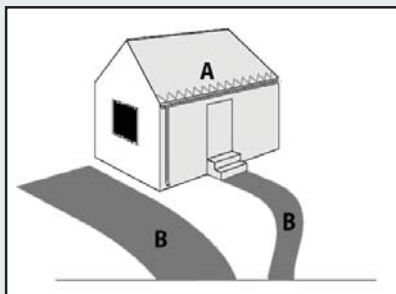

Two Ground Zones

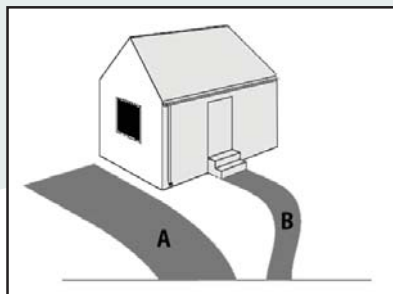

Two Roof Zones

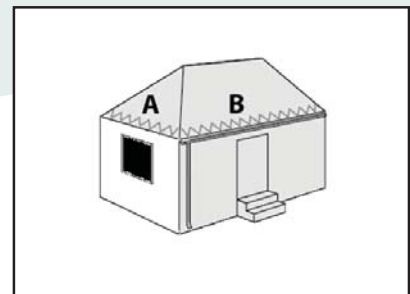

Ordering
Information PG. 19

Danfoss GX

Electric Snow Melting

Electric Snow Melt Controllers

DS-2B/DS-5 Snow Melt Controllers

The DS-2B/DS-5 Snow Melt Controllers are designed for pavement snow melt applications. They can be used as a stand alone controller or as a sensor for larger control systems.

- Housed in a weatherproof enclosure
- Senses both moisture and temperatures
- Adjustable temperature trigger point
- Adjustable delay off drying time
- Manual override capable
- Selectable low temperature cutoff
- Remote control and monitor capabilities
- Easy to install
- Two year warranty



Technical Data	DS-2B	DS-5
Power Control Voltage:	120V/240V field selectable	
Max. Heating Load:	30A	60A (2 x 30A)
Max. Ambient Temperature:	-40°F to +185°F (-40°C to +85°C)	
Enclosure Type:	NEMA 3R	
Mounting:	Wall/pole mounted, outdoors	
Dimensions (H x W x D):	4.75" x 7.00" x 2.75" (121 mm x 178mm x 70mm)	



Ordering Information	GX Controls	
Part No.	Description	Voltage
088L3035	DS-2B Snow Melt Controller (30A)	120V, 240V
088L3037	DS-5 Snow Melt Controller (60A)	120V, 240V
088L3036	DS-8 Snow Melt Controller (30A)	120V, 240V
088L3411	GX850 Dual Zone Automatic Control Panel (ACP)*	208V - 600V

*Requires ground and / or roof sensors (see page 20 for ordering information)

*Control voltage 120V

DS-5 Controller



Part # 088L3037

DS-8 Controller



Part # 088L3036

GX 850 ACP



Part # 088L3411

Danfoss GX

Electric Snow Melting

Electric Snow Melting Panels

Contactor & Timer Panels



The Danfoss Contactor and Timer panels are primarily designed for snow and ice melting applications. All panels are pre-wired and UL listed complete with a NEMA 1 enclosure, wiring diagram, terminal connection block, timer (timer panels), and two or four 3-pole contactors. Timer panels can be used stand alone or in conjunction with an automatic controller. Contactor panels must be used in conjunction with an automatic controller.

- Low Cost
- Easy to install
- NEMA 1, UL listed panel box
- Heat on indicator light
- Pre-wired terminal connections
- Two year warranty

Technical Data	Contactor / Timer Panels
Power Voltage Range:	208V - 600V
Max. Heating Load:	100A/200A
Control Voltage:	120V
Enclosure Type:	NEMA 1
Mounting:	Wall mounted, indoors
Dimensions (H x W x D):	10" x 10" x 4" (254mm x 254mm x 102mm) 12" x 12" x 6" (305mm x 305mm x 152mm)
Timer Override:	4 Hours



GFEP (Ground Fault Equipment Protection) Contactor Panels



Simplify your installation with the GFEP Panels. Danfoss GFEP panels have built-in ground fault equipment protection, minimizing the risk of faults and eliminating extra wiring installation steps and costs. The panel can be activated by a Danfoss GX 850 ACP, DS controller or any other type of controller.

- Easy to install
- NEMA 1, UL listed enclosure
- Integrated 30mA GFEP (Optional)
- A LED trip indicator (internal)
- A LED heat on indicator
- Pre-wired terminal connections
- 120V on/off remote heat indicator
- Two year warranty

Technical Data	GFEP Panels
Power Voltage Range:	208V - 600V
Max. Heating Load:	100A/200A
Control Voltage:	120V
Enclosure Type:	NEMA1
Mounting:	Wall mounted, indoors
Dimensions (H x W x D)	12" x 12" x 6" (305mm x 305mm x 152mm) 16" x 16" x 6" (406mm x 406mm x 152mm)
GFEP:	30mA trip



Danfoss GX Electric Snow Melting

GX Timer / Contactor Panels

Ordering Information		GX Timer / Contactor Panels		
Part No.	Description	Max. Amps	Coil Voltage	No. of Contactors
088L3450	Single Contactor, 600V	40	120	1
088L3451	Single Contactor, 600V	40	208-240	1
088L3456	Single Contactor, 600V	60	120	1
088L3457	Single Contactor, 600V	60	208-240	1
088L3440	GX Timer Panel with 4hr Timer, 100A, 600V	100	120	2
088L3441	GX Contactor Panel without Timer, 100A, 600V	100	120	2
088L3442	GX Timer Panel with 4hr Timer, 200A, 600V	200	120	4
088L3443	GX Contactor Panel without Timer, 200A, 600V	200	120	4
088L3444	GX Contactor Panel with Timer and GFEP, 100A	100	120	2
088L3445	GX Contactor Panel with GFEP, 100A	100	120	2
088L3446	GX Contactor Panel with Timer and GFEP, 200A	200	120	4
088L3447	GX Contactor Panel with GFEP, 200A	200	120	4

All contactors are complete with NEMA 1 enclosure
 100A contactor / timer panels consist of two, 3P, 50A contactors
 200A contactor / timer panels consist of four, 3P, 50A contactors

Single Contactor



Electric Snow Melting Accessories

Ordering Information		GX Accessories
Part No.	Description	
088L1050	Cable Strapping (15 ft. / 4.5m)	
088L1054	Cable Strapping (75 ft. / 22.9m)	
088L3051	Ground Sensor (Two per package, includes 50 ft. / 15m lead wire)	
088L3052	Roof Sensor (includes 50 ft. / 15m lead wire)	
088L3405	Nameplate (per NEC 426-13)	
088L0010	GX Repair Kit (includes: crimp connectors, heat shrink tubes, repair wire)	
088L3038	CDP-2 Remote Control & Display for Snow Sensors*	
088L3039	CS-1 Remote Control / Monitor Pigtail for CDP-2	
89999997	Extended Power leads, factory spliced, 5 ft increments **	

*CDP-2 installation requires use of CS-1 pigtails
 *CDP-2 can be used with DS-2B and DS-5 controllers
 **Allow 6-8 weeks delivery time

Cable Strapping



Ground Sensors



CDP-2 Remote Control



GX Repair Kit



Nameplate



Roof Sensor





Danfoss RX Roof & Gutter De-Icing

Roof and Gutter De-Icing Cables

Danfoss RX Cables provide the protection needed to prevent ice dams and build-up from damaging RESIDENTIAL buildings, roofs, and gutters. Danfoss RX constant watt heating cables ensure maximum energy efficiency and are designed for use with metal or asphalt roofing. Durable and high-quality materials provide excellent moisture, corrosion and impact protection. Simply plug the RX cables directly to the power receptacle

- Professional grade cable and AC Plug
- 100% aluminum foil screen
- Electrical Shock Resistant (ESR)
- High grade heating element
- Durable and high-quality materials provide excellent moisture, corrosion and impact protection
- Tough UV rated cable will withstand the harshest conditions
- Kit comes complete with necessary shingle and spacer clips
- Two year warranty

Technical Data	RX Cables
Cable Construction:	Twin Conductor, constant watt
Cable Diameter:	1/4" (6mm)
Rated Voltage:	120V
Max. Rated Temperature:	220°F (105°C)
Conductor Insulation:	Teflon™ FEP
Outer Insulation:	PVC



Ordering Information	RX Cables			120V	
Part No.	Length (ft)	Watts	Amps	Shingle Clips Included in Kit	Spacer Clips Included in Kit
088L3500	30	170	1.4	25	10
088L3502	65	310	2.6	25	10
088L3503	80	390	3.3	50	10
088L3504	100	450	3.8	50	10
088L3505	120	535	4.5	75	10
088L3508	170	760	6.3	100	10
088L3510	230	1080	9.0	100	10
088L3511	265	1220	10.2	125	10

KIT INCLUDES

- 120V, heating cable with grounded plug
- spacer clips
- shingle clips
- instruction manual
- 6ft. power lead

For Product Selector
See PG. 22

Controls - See PG. 23
Accessories- See PG. 24

Danfoss RX Roof & Gutter De-Icing

Roof & Gutter De-Icing Cables

Product Selector for a Basic Roof

1. Total length (ft) of roof line (A) X 5 = RL
2. Total length (ft) of all down spouts (E) X 2 = DS
3. Add RL + DS = estimated length (ft) of cable required

**see manual for more complicated roof lines

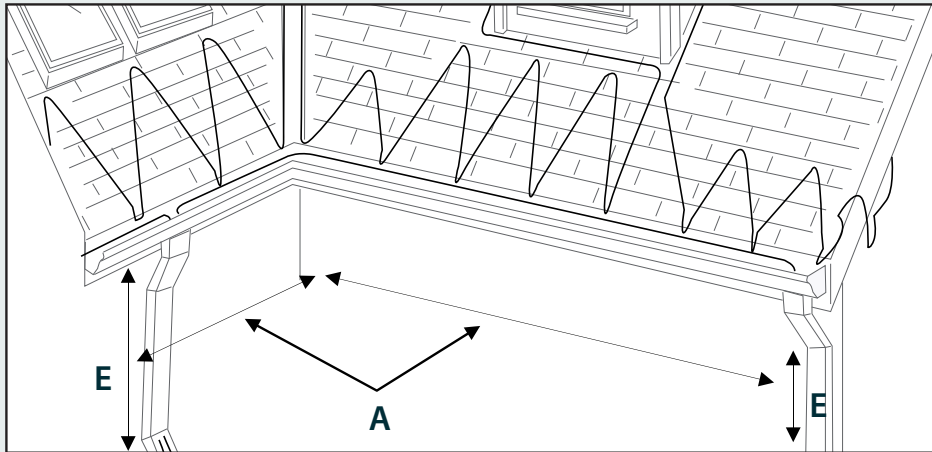

Commercial Roof & Gutter De-Icing Cables

Danfoss RX-C Roof and Gutter De-icing Self-regulating cables provide the protection needed to prevent ice dams and build-up from damaging COMMERCIAL buildings, roof, and gutters. RX-C Roof and Gutter De-icing Cables are UV-rated.

Technical Data	RX-C Cables
Cable Construction:	Self Regulating
Cable Diameter:	0.45" x 0.216" (11.5mm x 5.5mm)
Rated Voltage:	120V, 208V-277V
Max Rated Temperature:	150°F (65°C) powered 185°F (85°C) un-powered
Nominal Power Output:	5W/ft @ 50°F (10°C 15W/m)
Output in Ice or Snow:	12W/ft @ 32°F (0°C 40W/m)
Conductor Insulation:	PEX/TPE
Outer Insulation:	TPE



Ordering Information	RX-C Cables		
Part No.	Length (ft)	Volts	Output @ 50°F (10°C)
088L1422	250 ft. spool	120	5W/ft
088L1472	1000 ft. spool	120	5W/ft
088L1432	250 ft. spool	240	5W/ft
088L1473	1000 ft. spool	240	5W/ft
088L1462	Cut to order / by ft.*	120	5W/ft
088L1463	Cut to order / by ft.*	240	5W/ft

See Maximum Total Cable Length on page 28

*Minimum Order is 25 ft.



Controls - See PG. 23
Accessories- See PG. 24

Danfoss RX

Roof & Gutter De-Icing

Roof & Gutter De-Icing Controls

DS-8 Snow Melt Controller



The DS-8 is designed for roof and gutter, snow and ice melting applications. The sealed, low voltage, remote mount precipitation sensor can be mounted in a down spout, on the back of a gutter, under the drip edge, up to 10 feet away, while keeping the main controller in a more convenient and protected location.

- Housed in a weatherproof enclosure
- Senses both moisture and temperature
- Adjustable temperature trigger point
- Adjustable delay off drying time (30-90 mins)
- Manual override capable
- Bright on/off triggered LED status indicator
- Remote control capabilities
- Two year warranty

Technical Data	DS-8
Power Control Voltage:	120V,240V field selectable
Max. Heating Load:	30A @ 240V
Max. Ambient Temperature:	-40°F to +185°F (-40°C to +85°C)
Enclosure Type:	NEMA 3R
Mounting:	Wall/pole mount, outdoors
Dimensions (H x W x D):	4.75" x 7.00" x 2.75" (120mm x 178mm x 70mm)



Weatherproof Thermostat

The Weatherproof thermostat is designed for temperature control applications and serves as an operational control only.



- Automatic activation-reduced operational costs
- Remote bulb temperature sensing
- Large, readily visible dial
- Wall mounted
- Water-tight enclosure
- Two year warranty

Technical Data	Weatherproof Thermostats
Voltage:	120V - 277V
Max. Heating Load	25A @ 120V - 240V, 22A @ 277V
Max. Ambient Temperature:	0°F to +120°F (-18°C to + 49°C)
Enclosure Type:	NEMA 4X
Mounting:	Wall mounted
Dimensions (W x H x D):	3.06" x 6.38" x 2.50" (78mm x 162mm x 63mm)
Capillary Length:	60" (1524mm)



Ordering Information	RX Controls
Part No.	Description
088L3036	DS-8 Controller with Remote Snow and Ice Sensor
088L3422	Weatherproof with Water-tight Enclosure

Danfoss RX Roof & Gutter De-Icing

Roof & Gutter De-Icing Accessories

Ordering Information	RX Accessories
Part No.	Description
088L0024	RX-C Roof Clips Type A (25 / bag)
088L3002	Down Spout Edge Protection Plate (1 / bag)
088L3003	RX-C Roof Clips Type B (20 / bag)
088L3004	RX Kit Spacer Clips (10 / bag)
088L3005	RX Kit Shingle Clips (25 / Bag)
088L3038	CDP-2 Remote Control & Display Panel for DS-8*
088L3039	CS-1 Remote Control / Monitor Pigtail for CDP-2
088L0006	Power Connection Kit, cable to power lead, includes one end seal
088L0008	Splice / Tee Kit, includes one end seal
088L1457	End Seal Kit, includes 5 end seals
088L0023	Power Connection Kit, cable to box, includes one end seal

*CDP-2 installation requires use of CS-1 Pigtail (Part # 088L3039)

RX-C Roof Clips Type A



RX-C Roof Clips Type B



RX Kit Spacer Clips



RX Kit Shingle Clips



Typical Installation with Plastic Clips

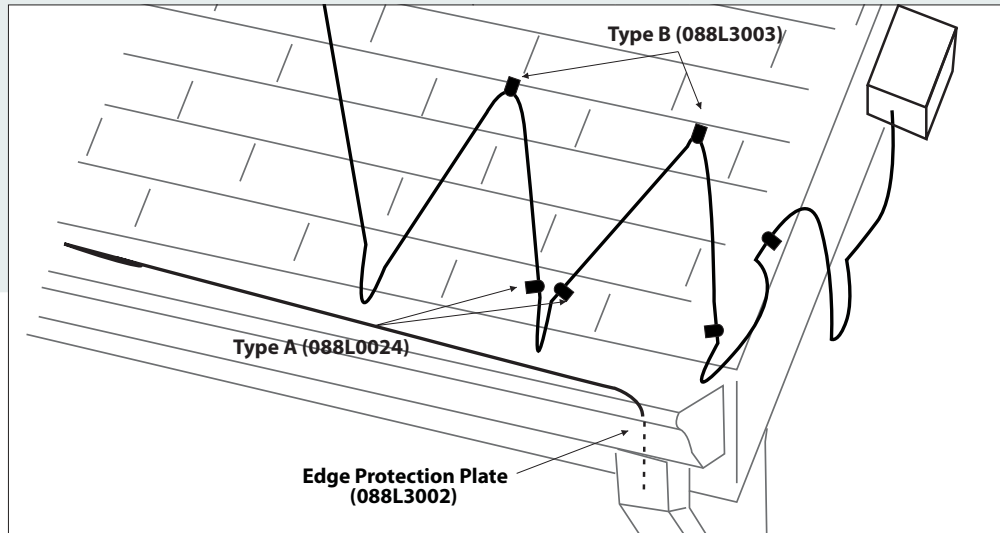

Power Connection Kit
(Cable to Lead)



Power Connection Kit
(Cable to Box)



RX End Seal Kit (5pcs)



CDP-2 Remote Control



RX Downspout Edge
Protection Plate



Danfoss PX Self-Regulating Cables



Pipe Freeze Protection

The Danfoss PX Series of SELF-REGULATING Parallel Circuit Heating Cables provide the solution to basic FREEZE PROTECTION applications. The self regulating Danfoss PX series ensures maximum energy efficiency by producing heat only when and where it is needed as it adjusts the power output to the varying conditions along the length of the pipe.

- Cable can be overlapped without creating hot spots or causing a burn out
- Cable can be cut and spliced in the field, simplifying the installation process and reducing waste
- Rugged 16 AWG bus cable with longer runs
- Wide variety of heat outputs available
- Limited 10 year warranty



Technical Data	PX Cables
Available Power Outputs:	3, 5, 8, 10 W/ft at 240 VAC and 120 VAC at 50°F (+10°) (10, 15, 25, 33)W/m at 240 VAC and 120 VAC at 50°F (+10°C)
Cable Diameter:	0.45" x 0.216" (11.5mm x 5.5mm)
Rated Voltage:	120V - 277V Max.
Minimum Bending Radius:	1" (25mm)
Max. Rated Temperature:	150°F (65°C) Powered 185°F (85°C) Un-powered
Bus Wire Type:	16 AWG (1.25mm ²) Tinned Copper



Danfoss PX Cables

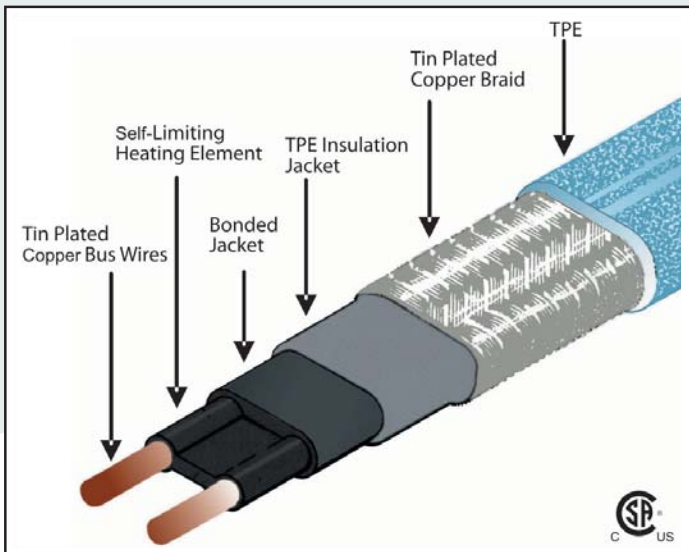

Typical Applications

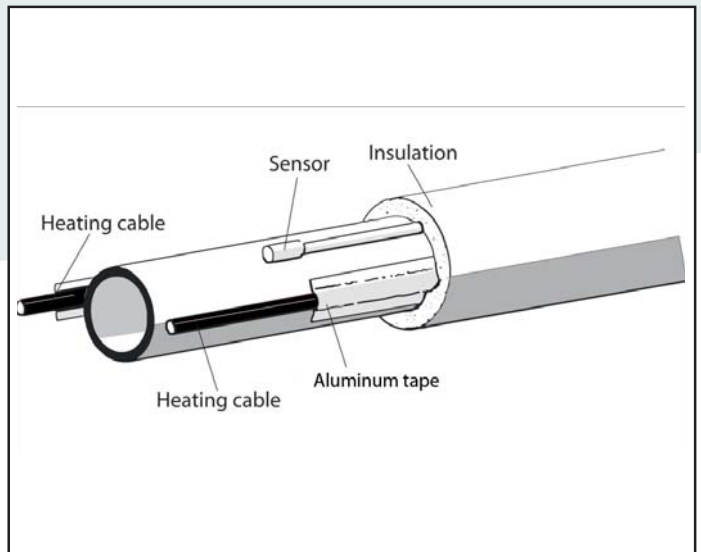

Danfoss PX Self-Regulating Cables

Pipe Freeze Protection

Ordering Information		PX Cables by the Spool	
Part No.	Voltage	Output at 50°F (10°C)	Spool Size (feet)
088L1402	120V	3W/ft	250
088L1470	120V	3W/ft	1,000
088L1412	240V	3W/ft	250
088L1471	240V	3W/ft	1,000
088L1422	120V	5W/ft	250
088L1472	120V	5W/ft	1,000
088L1432	240V	5W/ft	250
088L1473	240V	5W/ft	1,000
088L1516	120V	8W/ft	250
088L1517	120V	8W/ft	1,000
088L1518	240V	8W/ft	250
088L1520	120V	10W/ft	250
088L1519	240V	8W/ft	1,000
088L1521	120V	10W/ft	1,000
088L1522	240V	10W/ft	250
088L1523	240V	10W/ft	1,000

Ordering Information		PX Cables Cut to Length	
Part No.	Output at 50°F (10°C)	Voltage	
088L1460	3W/ft	120V	
088L1461	3W/ft	240V	
088L1462	5W/ft	120V	
088L1463	5W/ft	240V	
088L1469	8W/ft	120V	
088L1468	8W/ft	240V	
088L1479	10W/ft	120V	
088L1478	10W/ft	240V	

Danfoss PX Output Curves

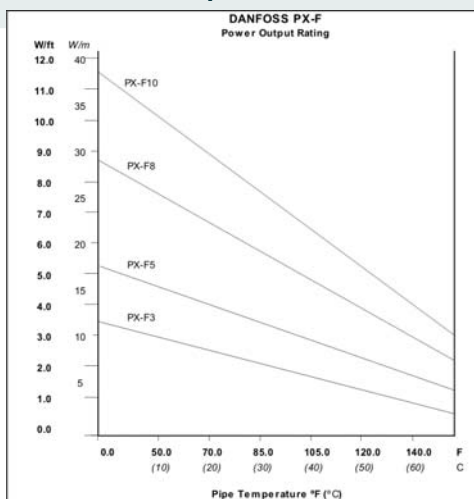

Voltage Conversion Table W/ft (W/m) @50°F (10°C)

CABLE	208V	240V	277V
PX-F3	2.5 (8.5)	3.0 (10.0)	3.5 (12.5)
PX-F5	4.0 (13.5)	5.0 (15.0)	5.5 (17.5)
PX-F8	7.0 (23.0)	8.0 (25.5)	8.5 (27.5)
PX-F10	9.5 (31.5)	10.0 (33.0)	10.5 (35.0)

Controls - See PG. 28
Accessories- See PG. 28

Danfoss PX Self-Regulating Cables

Pipe Freeze Protection



PX Cable Selection Chart					120V	
Insulation Thickness	1/2" Min.		1" Min.		2" Min.	
Pipe Material	Metal	PVC	Metal	PVC	Metal	PVC
Pipe Diameter (Inches)						
1/2	3W/ft	5W/ft	3W/ft	3W/ft	3W/ft	3W/ft
3/4	3W/ft	5W/ft	3W/ft	3W/ft	3W/ft	3W/ft
1	5W/ft	5W/ft	3W/ft	3W/ft	3W/ft	3W/ft
1 1/4	5W/ft	8W/ft	3W/ft	5W/ft	3W/ft	3W/ft
1 1/2	5W/ft	8W/ft	3W/ft	5W/ft	3W/ft	3W/ft
2	5W/ft	8W/ft	5W/ft	5W/ft	3W/ft	3W/ft
2 1/2	8W/ft	10W/ft	5W/ft	5W/ft	3W/ft	3W/ft
3	8W/ft	10W/ft	5W/ft	5W/ft	3W/ft	5W/ft
4	10W/ft	10W/ft*	5W/ft	8W/ft	3W/ft	5W/ft
6	10W/ft*	10W/ft*	8W/ft	10W/ft	5W/ft	5W/ft
8	-	-	10W/ft	10W/ft*	5W/ft	8W/ft

Chart based on minimum ambient temperature -22°F (-30°C)
*Requires 2 runs

PX Cable Selection Chart					240V	
Insulation Thickness	1/2" Min.		1" Min.		2" Min.	
Pipe Material	Metal	PVC	Metal	PVC	Metal	PVC
Pipe Diameter (Inches)						
1/2	3W/ft	5W/ft	3W/ft	3W/ft	3W/ft	3W/ft
3/4	3W/ft	5W/ft	3W/ft	3W/ft	3W/ft	3W/ft
1	5W/ft	5W/ft	3W/ft	3W/ft	3W/ft	3W/ft
1 1/4	5W/ft	8W/ft	3W/ft	5W/ft	3W/ft	3W/ft
1 1/2	5W/ft	8W/ft	3W/ft	5W/ft	3W/ft	3W/ft
2	5W/ft	8W/ft	5W/ft	5W/ft	3W/ft	3W/ft
2 1/2	8W/ft	10W/ft	5W/ft	5W/ft	3W/ft	3W/ft
3	8W/ft	10W/ft	5W/ft	5W/ft	3W/ft	5W/ft
4	10W/ft	10W/ft*	5W/ft	8W/ft	3W/ft	5W/ft
6	10W/ft*	10W/ft*	8W/ft	10W/ft	5W/ft	5W/ft
8	-	-	10W/ft	10W/ft*	5W/ft	8W/ft

Chart based on minimum ambient temperature -22°F (-30°C)
*Requires 2 runs

Controls - See PG. 28
Accessories- See PG. 28

Danfoss PX Self-Regulating Cables

Pipe Freeze Protection

Maximum Total Cable Length ft (m)									
Start-up Temp.	120 VAC				240 VAC				
	Breaker Size	15A	20A	30A	40A	15A	20A	30A	40A
PX-F3 50°F (+10°C)		315 (95)				672 (205)			
	5°F (-15°C)	266 (69)	295 (90)	312 (95)		460 (140)	610 (186)	640 (195)	
	-15°F (-25°C)	197 (60)	266 (81)	312 (95)		400 (123)	541 (165)	640 (195)	
PX-F5* 50°F (+10°C)		197 (67)	262 (80)			475 (145)	532 (162)		
	5°F (-15°C)	148 (45)	200 (61)	262 (80)		300 (93)	410 (125)	525 (160)	
	-15°F (-25°C)	131 (40)	177 (54)	262 (80)		265 (82)	365 (111)	525 (160)	
PX-F8* 50°F (+10°C)		141 (43)	190 (58)	206 (63)		285 (88)	384 (117)	413 (126)	
	5°F (-15°C)	96 (30)	128 (39)	190 (58)	203 (62)	197 (60)	246 (75)	384 (117)	410 (125)
	-15°F (-25°C)	88 (27)	108 (33)	167 (51)	203 (62)	164 (50)	230 (70)	345 (105)	410 (125)
PX-F10* 50°F (+10°C)		108 (33)	148 (45)	177 (54)		230 (70)	295 (90)	354 (108)	
	5°F (-15°C)	82 (25)	108 (33)	150 (46)	174 (53)	165 (50)	213 (65)	312 (95)	345 (105)
	-15°F (-25°C)	72 (22)	98 (30)	141 (43)	174 (53)	148 (45)	190 (58)	279 (85)	345 (105)

*RX-C Cable

Pipe Freeze Protection Weatherproof Thermostat

The Weatherproof Thermostat is designed for temperature control applications and serves as operational control only.

- Automatic activation - reduced operational costs
- Remote bulb temperature sensing
- Large, readily visible dial
- Wall mounted
- Water-tight enclosure



Ordering Information		PX Controls
Part No.	Description	Voltage
088L3422	Weatherproof thermostat with water-tight enclosure	120V - 277V

For technical data on Weatherproof Thermostat (see page 23)

Ordering Information		PX Accessories
Part No.	Description	
088L0006	Power Connection Kit, Cable to power lead, includes one end seal	
088L0008	Splice / Tee Kit, one end seal	
088L1457	End Seal Kit, includes 5 end seals	
088L0009	Aluminum Application Tape (75 ft.)	
088L0023	Power Connection Kit, cable to box, includes on end seal	
088L0412	Warning Labels, 10 pcs.	

Warning Labels



Part # 088L0412

RX End Seal Kit (5pcs)



Part # 088L1457

Aluminum Tape



Part # 088L0009

Splice / Tee Kit

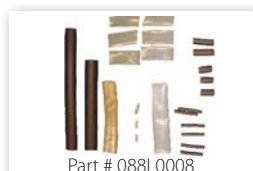

Part # 088L0008

Power Connection Kit
(Cable to Lead)



Part # 088L0006

Power Connection Kit
(Cable to Box)



Part # 088L0023

Danfoss Ice Guard Self-Regulating Cables



Freeze Protection

The Danfoss Ice Guard (SRIG) heating cable provides an easy to use solution for a variety of pipe freeze and roof and gutter applications. The heat output of the conductive core material increases and decreases when it is needed as it adjusts the power output to the varying conditions along the length of the pipe. This ensures maximum energy efficiency by producing heat only when and where it is needed.

- Cable can be overlapped without creating hot spots or causing a burn out
- 6 foot long power lead
- Pre-terminated with a plug and end seal
- Rugged 16 AWG bus cable with longer runs
- Limited 10 year warranty

Technical Data	Ice Guard (SRIG) Cables
Available Power Outputs:	5W / ft. at 240VAC and 120VAC at 50°F (+10°C)
Power Lead:	6ft. long
Cable Diameter:	0.45" x 0.216" (11.5mm x 5.5mm)
Rated Voltage:	120V - 277V Max.
Minimum Bending Radius:	1" (25mm)
Max. Rated Temperature:	150°F (65°C) Powered 185°F (85°C) Un-powered
Bus Wire Type:	16 AWG, (1.25mm ²), Tinned Copper



Ordering Information	Ice Guard (SRIG) Cable	120V
Part No.	Length (ft.)	Output @ 50°F
088L1480	6 ft	5W/ft
088L1481	12 ft	5W/ft
088L1482	18 ft	5W/ft
088L1483	24 ft	5W/ft
088L1484	50 ft	5W/ft
088L1485	75 ft	5W/ft
088L1486	100ft	5W/ft

Ordering Information	Ice Guard (SRIG) Cable	240V
Part No.	Length (ft.)	Output @ 50°F
088L1490	6 ft	5W/ft
088L1491	12 ft	5W/ft
088L1492	18 ft	5W/ft
088L1493	24 ft	5W/ft
088L1494	50 ft	5W/ft
088L1495	75 ft	5W/ft
088L1496	100ft	5W/ft

Danfoss TX_{FH} Electric Floor Heating

Electric Floor Heating Cables

Danfoss TX_{FH} Cables are a thick floor heating solution. Thick cables have a larger diameter than the Danfoss LX Floor heating cables, allowing them to be lower in COST, higher in HEAT OUTPUT and more DURABLE. They are installed in mud beds below the flooring materials and are most often used in new construction where overall material cost is a primary concern.

- Extremely durable
- High output means less cable required
- Single point connection
- Twin conductor cable
- Eliminates EMF's (electromagnetic fields)
- Safety approved for wet locations
- Genuine ten year non-prorated warranty, includes labor and material

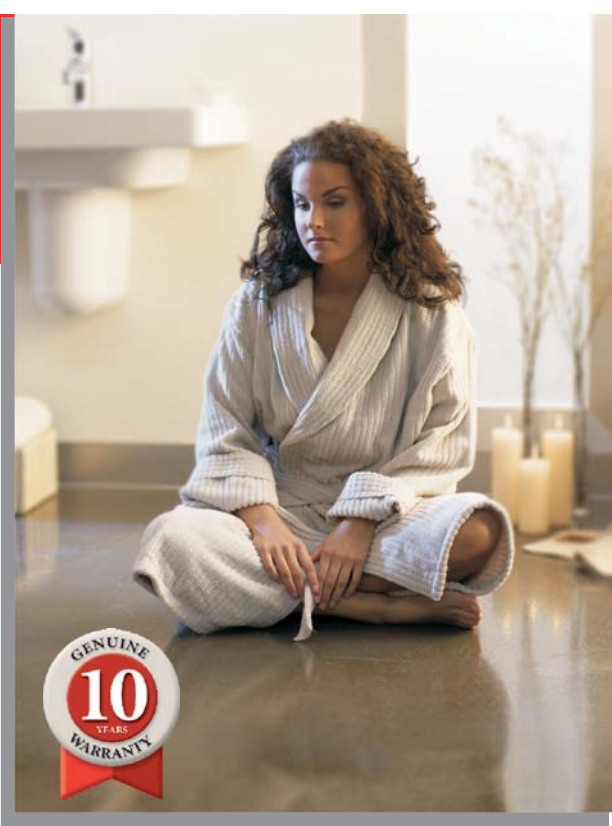

Technical Data		TX _{FH} Floor Heating Cables
Cable Construction:	Twin Conductor	
Cable Diameter:	1/4" (6mm)	
Rated Voltage:	240V	
Max. Rated Temperature:	220°F (105°C)	
Conductor Insulation:	Teflon™ FEP and XLPE	
Outer Insulation:	PVC	



Technical Data		TX _{FH} Floor Heating Cables			240V	
Part No.	Length (ft.)	Approximate Heat Coverage (sq. ft.)			Watts (6W/ft.)	Amps
		4" Spacing	5" Spacing	6" Spacing		
088L3700	60	20	25	30	344	1.4
088L3701	90	30	35	45	515	2.1
088L3702	115	40	50	60	683	2.8
088L3703	145	50	60	75	852	3.6
088L3704	175	60	75	90	1026	4.3
088L3705	210	70	90	105	1226	5.1
088L3706	240	80	100	120	1395	5.8
088L3707	300	100	125	150	1735	7.2
088L3708	355	120	150	180	2072	8.6
088L3710	415	140	170	205	2410	10.0
088L3711	470	155	195	235	2756	11.5
088L3712	530	175	220	265	3097	12.9
088L3713	595	200	250	295	3470	14.5
088L3714	680	225	285	340	3972	16.6

Cable Notes:

- Power leads are 10 feet in length
- 4" centers provide approximately 17W/sq.ft.
- 5" centers provide approximately 14W/sq.ft.
- 6" centers provide approximately 12W/sq.ft.
- Watt output of the 240V cable is reduced by 25% when operated at 208V (approximately 4.5W/ft.)

Controls - See PG. 32
Accessories- See PG. 32

Danfoss TX_{SH} Thermal Storage Heating

Thermal Storage Heating Mats & Cables

Danfoss TX_{SH} (Storage Heating System) heating mats and cables are energized to warm a thermal mass below the floor surface. Danfoss TX_{SH} is the ideal way to take advantage of local on-peak and off-peak energy prices. When the power system is in off-peak times, energy rates are lower. When on peak times resume, the Danfoss TX_{SH} system shuts off and the heat stored in the floor gently emanates across the floor surface for hours. The Danfoss TX_{SH} system provides an energy efficient and cost effective method of heating, in a clean and silent manner.

- Twin conductor cable
- Single point connection
- Easy and flexible installation
- Durable construction
- Eliminates EMF's (electromagnetic fields)
- Silent, efficient, automatic and safe
- Lower capital and operational costs
- Genuine ten year non-prorated warranty, includes labor and material



Technical Data TX_{SH} Storage / Slab Heating Cables

Cable Construction:	Twin Conductor
Cable Diameter:	1/4" (6mm)
Rated Voltage:	240V
Max. Rated Temperature:	220°F (105°C)
Conductor Insulation:	Teflon™ FEP
Outer Insulation:	PVC



Technical Data TX_{SH} Storage / Slab Heating Cables 240V

Part No.	Length (ft.)	Approximate Heat Coverage (sq. ft.)			Watts (9W/ft.)	Amps
		4" Spacing	5" Spacing	6" Spacing		
088L3723	115	40	50	60	1083	4.5
088L3729	190	60	80	95	1762	7.3
088L3733	240	80	100	120	2150	9.0
088L3735	285	95	120	145	2595	10.8
088L3737	330	110	140	165	3031	12.6
088L3739	375	125	160	185	3469	14.5
088L3741	425	140	175	210	3865	16.1
088L3743	475	155	200	235	4364	18.2
088L3745	545	180	225	270	5009	20.9

Cables Notes:

- Power leads are 10 feet in length
- 4" centers provide approximately 27W/sq.ft.
- 5" centers provide approximately 22W/sq.ft.
- 6" centers provide approximately 18W/sq.ft.
- Watt output of the 240V cable is reduced by 25% when operated at 208V (approximately 4.5W/ft.)

Mat Notes:

- Power leads are 10 feet in length
- All mats are 2 feet in width
- Watt output of the 240V cable is reduced by 25% when operated at 208V (approximately 15W/sq.ft.)

Technical Data TX_{SH} Storage / Slab Heating Mats 240V

Part No.	Length (ft)	Coverage (sq. ft.)	Watts (20W/sq.ft.)	Amps
088L3310	12.5	25	550	2.3
088L3312	30.0	60	1200	5.0
088L3314	52.5	105	2260	9.4
088L3316	80.0	160	3385	14.1
088L3318	92.5	185	3610	15.0
088L3320	117.5	235	4760	20.0

Controls - See PG. 32
Accessories- See PG. 32

Danfoss TX Thermal Storage Heating

TX Controls

Ordering Information		TX _{FH} Controls	120V - 240V
Part No.	Description		
088L5130	Programmable Thermostat with Floor Sensor		
088L5132	Programmable Thermostat with Air Sensor (and floor temperature limiter)		
088L5133	Non-Programmable Thermostat with Floor Sensor		

Floor sensing thermostats include a Floor Sensor with a 10 foot lead
For more information see page 5

Ordering Information		TX _{SH} Controls
Part No.	Description	
088L5132	Programmable Thermostat with Air Sensor (and floor Temperature limiter)	

For more information see page 5

Ordering Information		Timer / Contactor Panel		
Part No.	Description	Max. Amps	Coil Voltage	No. of Contactors
088L5135	Power Module with GFCI	15	N/A	1
088L3450	Single Contactor, 600V	40	120	1
088L3451	Single Contactor, 600V	40	208 - 240	1
088L3456	Single Contactor, 600V	60	120	1
088L3457	Single Contactor, 600V	60	208 - 240	1
088L3441	Contactor Panel without Timer, 600V	100	120	2
088L3443	Contactor Panel without Timer, 600V	200	120	4

Contactor or Power Module is required for loads exceeding 15 Amps on single thermostat
All contactors are complete with NEMA 1 enclosure
100A contactor panels consist of two 3P, 50A contactors
200A contactor panels consist of four 3P, 50A contactors
See page 18 for technical data and dimensions

TX Accessories

Ordering Information		TX Accessories
Part No.	Description	
088L0010	TX Repair Kit (Includes: Crimp connector, repair wire, heat shrink tubes)	
088L0028	Little Buzzer - Continuity Alarm	
088L1050	Cable Strapping (15ft. / 4.5m)	
088L1054	Cable Strapping (75ft / 22.8m)	
088L3008	Replacement Floor Sensor for Thermostat	
19809099	Sensor Conduit (8ft / 2.4m)	

Little Buzzer



Sensor Conduit



Floor Sensor



TX Repair Kit



Power Module



Single Contactor



Cable Strapping



Danfoss TX Thermal Storage Heating

Thermal Storage Heating Mats & Cables Typical Applications

SAND BED INSTALLATION

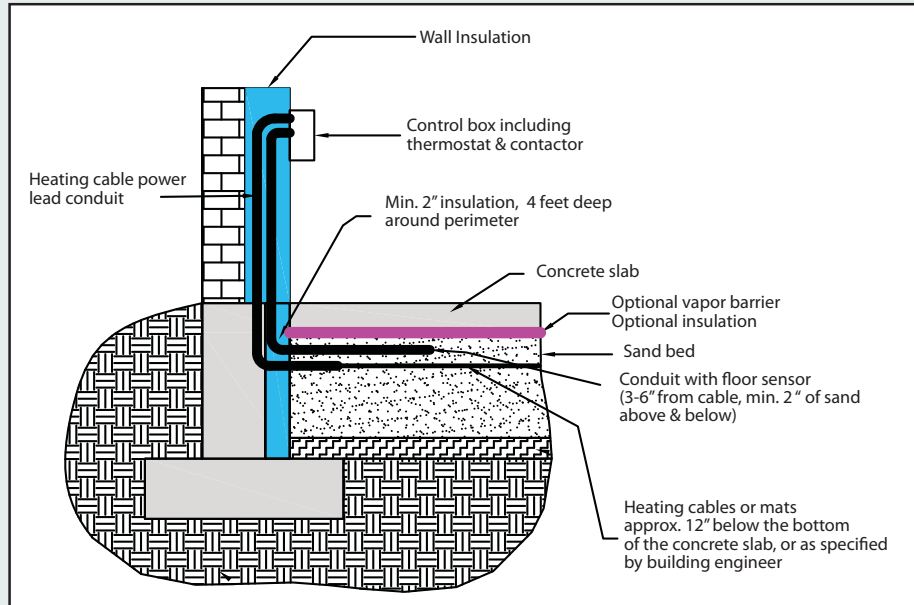

CONCRETE INSTALLATION

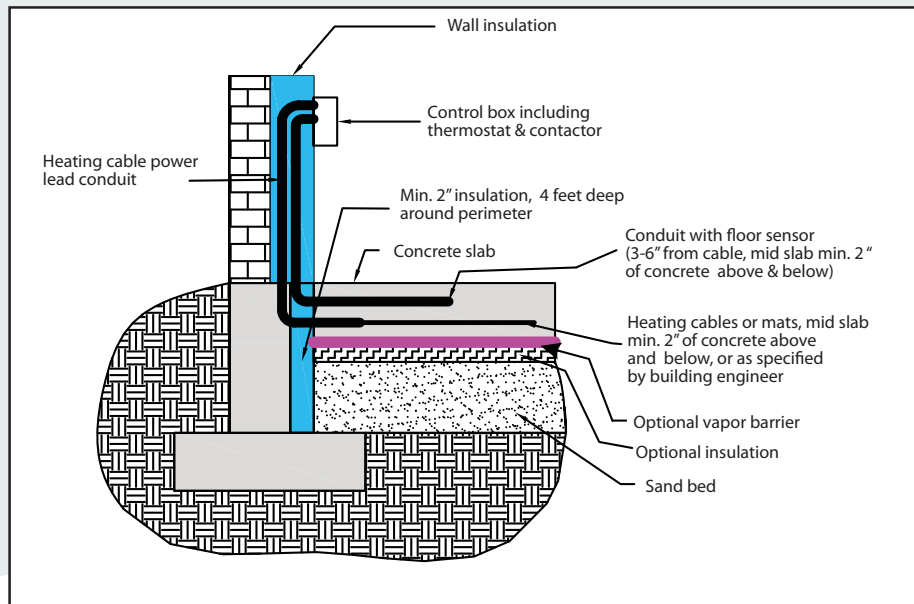



SUMMARY CONDITIONS FOR SALE AND WARRANTY

The acceptance of the order confirmation by the purchaser includes the acceptance of our "General Conditions of Sale and Warranty" as the only ruling condition. No modification of these conditions will be recognized by Danfoss. Any express or implied condition, statement or warranty, statutory or otherwise - not stated herein is excluded.

1. INCOTERMS

The international rules for the interpretation of trade terms "Incoterms" shall apply to the commercial terms used herein.

2. CONFIRMATION OF ORDER

Danfoss shall not be deemed to have accepted an order until written confirmation of the order from Danfoss is dispatched to the prospective purchaser. Quotations, pro forma invoices and the like, shall be subject to confirmation by Danfoss.

3. TERMS OF DELIVERY

At Danfoss' option, the goods can be delivered from any of the Danfoss factories, subsidiaries, or affiliated companies in or outside Canada. Failing special instructions, the goods will be dispatched in the way which Danfoss deems best without guaranteeing this to be the cheapest way of transport.

4. PRICE REGULATIONS

Danfoss reserves the right to adjust accepted prices in the event of alterations in rates of exchange, variations in costs of materials, changes in wages, interference on the part of the Government or similar conditions over which Danfoss has no control.

5. PACKING

Disposable packing is included in the price and will not be credited if returned. Reusable packing is not included in the price and shall be returned in accordance with Danfoss' instructions at purchaser's expense.

6. RISK

From the moment of delivery the purchaser shall bear all risks for the goods, and Danfoss shall not be responsible for loss and damage incurred during the transportation. If so desired by the purchaser, Danfoss will at the cost of and on behalf of the purchaser, effect marine insurance in English all risk conditions from warehouse to warehouse, at the c.i.f. value of the goods plus 10% and, likewise, Danfoss will effect war risk insurance.

7. TERMS OF PAYMENT

Where payment is not received when due, an interest rate of 10% per annum over and above the actual total back charge will be payable. This rate of interest will also be used in cases where an extension of the period of credit has been granted. The purchaser shall not be allowed to retain payments, or to settle debts by setting off same against possible counterclaims, disputed by Danfoss, or to reduce the invoiced price.

8. TRANSFER OF OWNERSHIP

Until full payment for the goods has been received by Danfoss, the goods shall remain the property of Danfoss and shall not be pawned or pledged in any way.

9. TIME OF DELIVERY

Time of delivery is stated approximately. Danfoss shall not be liable for any delay due to causes beyond Danfoss' control, including

but not restricted to strikes, lockouts, labour disturbances or the like, or in consequence of extraordinary measures on the part of government, hindrances to transportation including ice or other transport difficulties, delayed, incomplete or defective delivery of material ordered in due time from sub-suppliers, failing supply of electricity and similar obstacles to production, fire or workshop accidents at own factories or at sub-suppliers.

10. INFORMATION

The information and technical data contained in catalogues, leaflets and other written material constitutes an approximate guide only. No responsibility for errors or wrong interpretation can be placed on Danfoss. The purchaser cannot claim any rights based on this material. Such reservation shall also apply to suggestions, advice and other services rendered to customers, including installation and servicing instruction for the product delivered.

11. ALTERATIONS

Danfoss reserves the right to make alterations to their products without notice, also to products already placed on order.

12. WARRANTY

Danfoss warrants its products to be free of defects in material and workmanship for a period of time from the shipment to the original purchaser, assuming proper installation, proper maintenance, and normal operating conditions. Unless otherwise stated, Danfoss' obligation under this warranty shall be limited to repairing at its factory any part or parts thereof which shall be returned to its factory with transportation charges prepaid, and which upon examination shall appear to Danfoss' satisfaction to have been defective. Danfoss does not cover the cost of removal, freight, delivery and re-installment of the product. Correction of such defects by repair or replacement shall constitute fulfilment of all obligations to purchaser under this warranty. There is no other express warranty. Danfoss shall not be liable for incidental, consequential, or special damages arising from or in connection with the product use or performance. Danfoss assumes no liability of expenses of repairs made outside of its factory except by express written contract. This warranty supersedes all prior warranties.

Further information regarding the specific warranty details and period for each Danfoss product line can be found online and in the instruction manual and/or warranty card included with the product."

13. SECONDARY DAMAGES

Danfoss shall not be held responsible for any indirect or consequential damage e.g. damages to person or property, consequential loss, including loss of production, loss of profit, loss on goods in store or the like, which might arise out of defects and/or delay in delivery of the products sold, irrespective of the cause, including faulty manufacture, design of material.

14. NOTICE OF CLAIMS

Any claim or complaint as to defects and/or delay in delivery of the products shall be submitted in writing by the purchaser to Danfoss immediately.



GENERAL CONDITIONS FOR SALE AND WARRANTY

Minimum Order:

Handling charges of \$25 will be added to all orders less than \$100 net.

Freight:

All prices are FOB point of shipment.
Lowest cost transportation allowed on orders of \$1500 net or more
Partial shipment less than \$1500 net will not be freight allowed.

Payment Terms:

Net 30 days.
All orders subject to credit approval.
Interest rate of 1% per month applies to late payment.

Returns:

Returns accepted only with Returned Goods Authorization (RGA) obtained from Customer Service.

Return authorization must be received prior to return.

Subject to 25% restocking charge.

Goods returned must be new, in original packaging, unused and in resalable condition and are subject to inspection at Danfoss. Goods failing inspection will be returned collect with no credit issued.

No returns on special order items.

Danfoss reserves the right to limit returns.

Any Returns received without a Returned Goods Authorization Number will be returned to sender collect.

See General Terms of Sale and Warranty for complete Summary of Terms.

GO GREEN WITH DANFOSS



PART OF THE SOLUTION

International cooperation is key to reducing CO₂ emissions, an effective response to the global climate challenge also depends on innovation and intelligent technologies that both conserve natural resources and save money.

The task before us is to take these proven, energy-efficient technologies and apply them to solutions that can immediately reduce CO₂ emissions and save energy. The money these technologies save can then be invested in more long-term development of new, green energy sources.

At Danfoss, we offer more than 75 years experience in energy-efficient technologies. We are applying that core knowledge to traditional energy solutions as well as projects that use renewable energy sources, including wind and solar. At the same time, targeted investments in innovation and new development projects will continue to support the company's position as a leader in the green economy.

For more information on Danfoss' commitment to the environment, please visit:

www.danfoss.com/solutionsready



Danfoss

Danfoss
Toronto
Toll Free: 866-676-8062
Phone: 905-285-2050
Fax: 905-285-2055
www.LX.Danfoss.com