

# EXTROL<sup>®</sup> EXPANSION TANKS

For Closed Hydronic Heating, Radiant  
& Chilled Water Systems



# AMTROL® Quality Expansion Tanks

## Table of Contents

AMTROL Quality Expansion Tanks ....	2
How It Works.....	2
The EXTROL® System.....	3
Typical Residential Installation.....	3
Residential Models and Packages .....	4
The FILL-TROL® System.....	5
Commercial Non-ASME Models .....	6
Typical Commercial Installation .....	6
Commercial ASME Models .....	7
Sizing the EXTROL® .....	4, 6, 8

## The First in the Industry

AMTROL® designed and patented the first EXTROL® expansion tank in 1954, redefining hydronic heating systems. For five decades our unique, pre-pressurized, diaphragm-design EXTROL has been the world's leading expansion tank. EXTROL was designed to control system pressure and help reduce energy consumption of heating and circulating operations.

## The AMTROL Advantage

- AMTROL and its subsidiaries offer a complete line of quality engineered products for heating and water systems throughout the world.
- ISO 9001:2000 Certification reflects AMTROL's world-wide vision and commitment to excellence and customer focus.
- Full technical support is available at 401-535-1216.

## How AMTROL Expansion Tanks Work

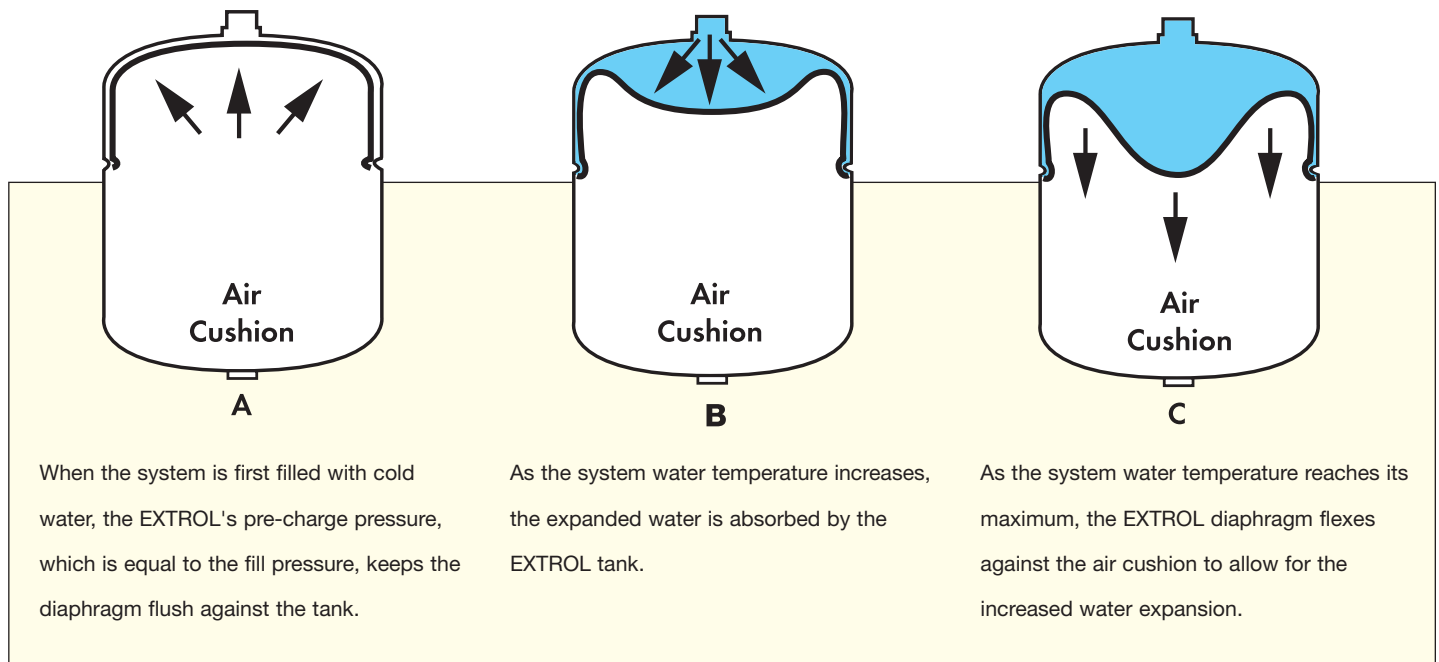

# The EXTROL® System

## AMTROL® EXTROL® System Advantages

- Provides permanent separation of system water from air cushion
- Controls system pressure
- Butyl/EPDM diaphragm for superior air retention — 9 times better than natural rubber
- Maintenance-free design

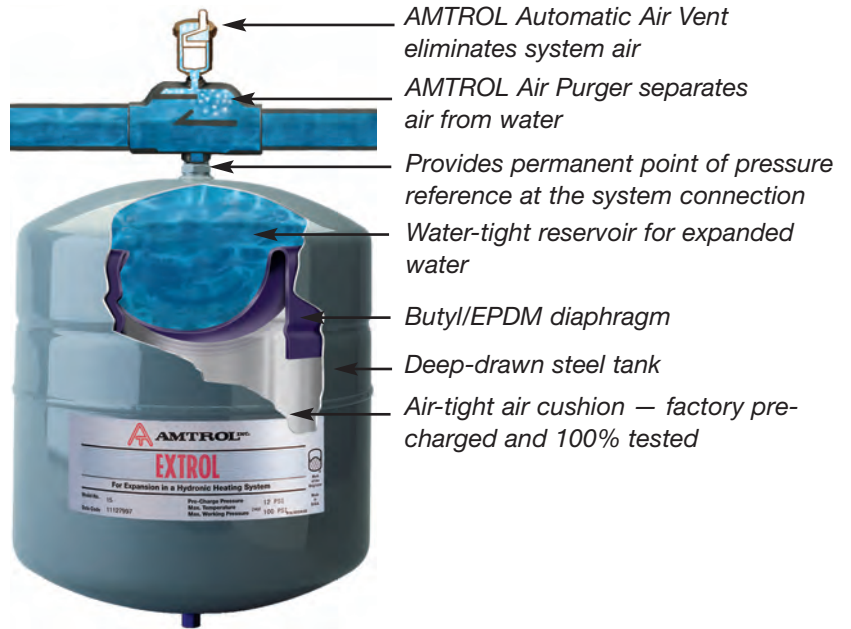

## Typical Installation of Residential Models

(The EXTROL is for use only in closed hydronic heating systems and chilled non-potable water systems.)

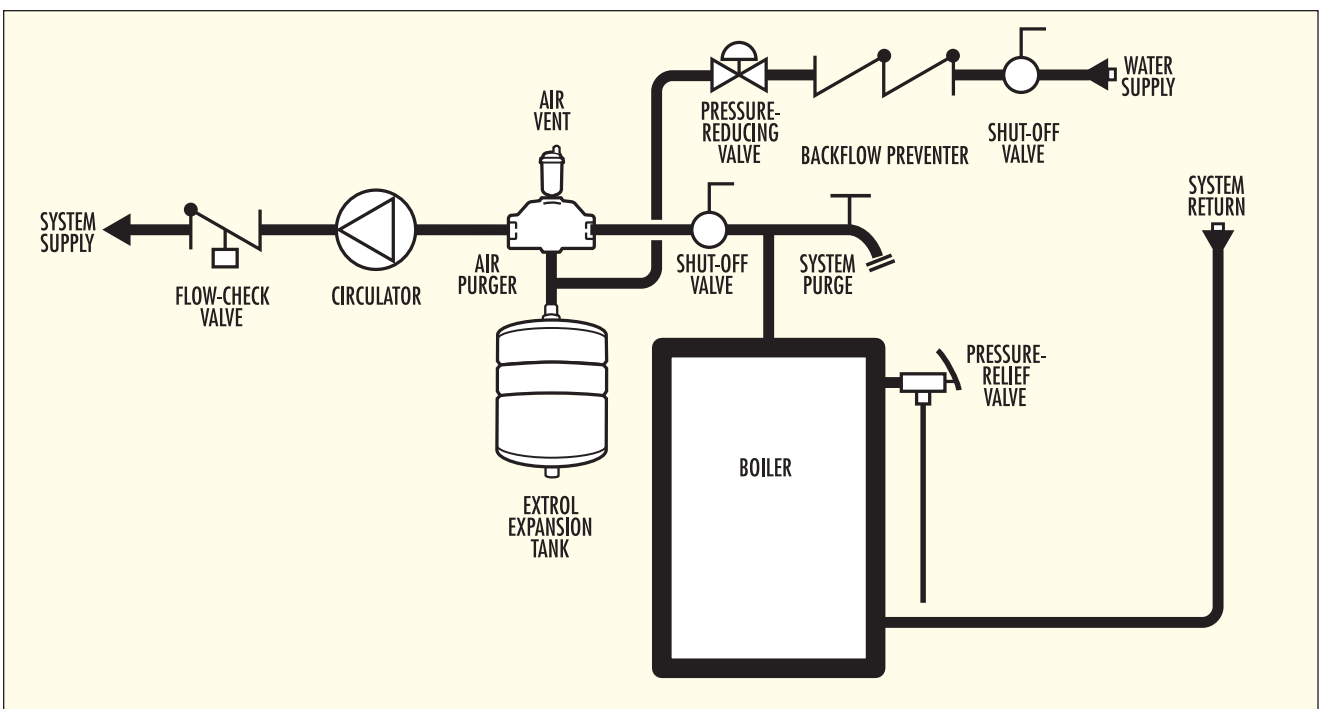

# Residential Models and Packages



## EXTROL®

- Factory pre-charged to 12 psig
- Maximum working pressure: 100 psig
- Maximum operating temperature: 240°F

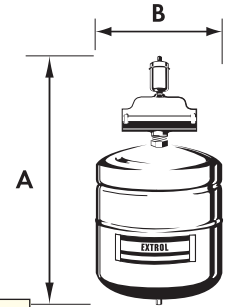

EXTROL Package

### EXTROL Specifications

Model Number	Tank Volume (Gallons)	Max. Accept. Volume (Gallons)	A Height (Inches)	B Diameter (Inches)	System Conn. <sup>1</sup> (Inches)	Shipping Weight (lbs.)
15	2.0	0.9	12 $\frac{3}{8}$	8	$\frac{1}{2}$	5
30	4.4	2.5	15 $\frac{1}{2}$	11	$\frac{1}{2}$	9
60	7.6	2.5	23	11	$\frac{1}{2}$	14
90	14.0	11.3	21	15 $\frac{3}{8}$	$\frac{1}{2}$	23

### EXTROL Combination Packages

Model Number	Extrol Model	Purger Model	Vent Model	Ship. Wt. (lbs.)
1500/1 or 1 $\frac{1}{4}$	15	443 or 444	700-C	9
3000/1 or 1 $\frac{1}{4}$	30	443 or 444	700-C	14
6000/1 $\frac{1}{4}$	60	444	700-C	19
6000/1 $\frac{1}{2}$	60	445	700-C	19

<sup>1</sup> System Connection is NPTM

## Sizing the EXTROL

### Sizing Based on BTU's

BOILER Net Output in 1000'S of BTU/Hr.	TYPE OF RADIATION			
	Finned Tube Baseboard or Radiant Panel	Convectors or Unit Heaters	Radiators Cast Iron	Baseboard Cast Iron
MBH	Use Model	Use Model	Use Model	Use Model
25	15	15	15	15
50	15	15	30	30
75	30	30	30	60
100	30	30	60	60
125	30	60	60	90
150	30	60	90	90
175	60	60	SX-30V	SX-30V
200	60	60	SX-30V	SX-30V
250	60	90	SX-30V	SX-40V
300	90	SX-30V	SX-30V	SX-40V
350	SX-30V	SX-30V	SX-40V	SX-60V
400	SX-30V	SX-40V	SX-40V	SX-60V

Sizing based on: • Fill Pressure 12 psig • Relief Pressure 30 psig • Average System Temp. 200°F • System filled with water • Consult factory for compatibility and sizing for other fluids.

### Sizing Based on Maximum System Temperature

Max. System Temp. °F	System Water Content in Gallons			
	Model 15	Model 30	Model 60	Model 90
100	125	275	417	876
110	93	205	311	653
120	72	158	239	502
130	58	128	194	407
140	48	105	160	336
150	40	89	134	282
160	34	76	115	241
170	30	65	99	208
180	26	57	87	182
190	23	51	77	161
200	20	45	68	143
210	18	40	61	129
220	17	37	55	116
230	15	33	50	106
240	14	30	46	96

Sizing by system temp. based on: • Max. Operating Temperature 240°F • Fill Pressure 12 psig • Relief Pressure 30 psig • Water Fill Temperature 40°F



## For Radiant Systems, Use RADIANT EXTROL™

- Specifically designed for high-efficiency radiant systems
- Plastic liner compatible with barrier and non-barrier systems
- Suitable for use in glycol applications
- Non-ferrous system connection for corrosion resistance
- Maximum working pressure: 100 psig
- Maximum operating temperature: 200°F

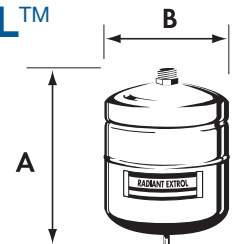

RADIANT EXTROL

### RADIANT EXTROL Tanks for Radiant Systems

Model Number	Tank Volume (Gallons)	Max. Accept. Volume (Gallons)	A Height (Inches)	B Diameter (Inches)	System Conn. <sup>1</sup> (Inches)	Shipping Weight (lbs.)
RX-15	2.0	0.9	12 $\frac{3}{8}$	8	$\frac{3}{4}$	5
RX-30	4.4	3.2	15 $\frac{1}{2}$	11	$\frac{3}{4}$	9
RX-60	10.3	10.3	19 $\frac{1}{4}$	15 $\frac{3}{8}$	1	23

<sup>1</sup> System Connection is NPTM

### Radiant Extrol Quick Sizing Chart

Feet of Tubing	Nominal Pex Tubing Size				
	3/8"	1/2"	5/8"	3/4"	1"
1000	RX-15	RX-15	RX-15	RX-15	RX-15
5000	RX-15	RX-15	RX-15	RX-30	RX-30
7500	RX-15	RX-15	RX-30	RX-30	RX-60
10000	RX-15	RX-30	RX-30	RX-60	RX-60
14000	RX-15	RX-30	RX-60	RX-60	
18000	RX-30	RX-60	RX-60	RX-60	
22000	RX-30	RX-60	RX-60		
30000	RX-30	RX-60			

See Precise Sizing on back page.

Based on 120°F operating temp. with 12psi fill and 30psi relief valve. For glycol applications, consult AMTROL Technical Support.

# The FILL-TROL® System – Expansion Control with Automatic Fill Feature



The AMTROL FILL-TROL® system consists of a specially adapted EXTROL pre-pressurized, diaphragm-type expansion tank, and the FILL-TROL, a specially designed, automatic, pressure-reducing fill valve.

- Provides accurate system make up
- Eliminates need for a separate, automatic fill valve
- Fully adjustable up to a maximum working pressure of 100 psig
- Factory pre-charged to 12 psig; tank pressure controls system fill

## FILL-TROL Specifications

Model Number	Tank Volume (Gallons)	Max. Accept. Volume (Gallons)	A Height (Inches)	B Diameter (Inches)	System Conn. <sup>1</sup> (Inches)	Shipping Weight (lbs.)
109	2.0	0.9	14 ¾	8	½	6
110	4.4	2.5	17 ¾	11	½	10
111	7.6	2.5	24 ¾	11	½	15
112	14.0	11.3	23	15 ¾	½	24

<sup>1</sup> System Connection is NPTF

Note: A standard EXTROL tank is not interchangeable with a FILL-TROL tank.

To use either sizing chart on page 4 for selection, 109 FILL-TROL is equivalent to #15 EXTROL, 110 FILL-TROL is equivalent to #30 EXTROL, 111 FILL-TROL is equivalent to #60 EXTROL, and 112 FILL-TROL is equivalent to #90 EXTROL.

## FILL-TROL Combination Packages

Model Number	FILL-TROL Model	Purger Model	Vent Model	Shipping Weight (lbs.)
109-P/1 or 1 ¼	109	443 or 444	700-C	10
110-P/1 or 1 ¼	110	443 or 444	700-C	14
111-P/1 ¼	111	444	700-C	18

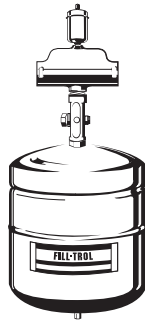
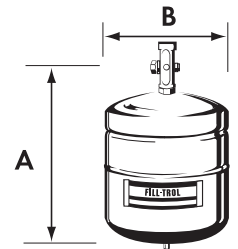

## How the FILL-TROL System Works

Water enters the FILL-TROL valve, pushing open the check valve, and flows into the heating system. The automatic shut-off valve is kept open by the diaphragm pressing against the pressure plate, raising the stem of the fill gate, which compresses the automatic shut-off valve spring. When the heating system reaches fill pressure (typically 12 psig), the tank's diaphragm depresses and the automatic shut-off valve is closed.

Whenever system pressure falls below the tank precharge, the automatic shut-off valve is pressed open by the diaphragm. Make-up water flows into the system to restore pressure.

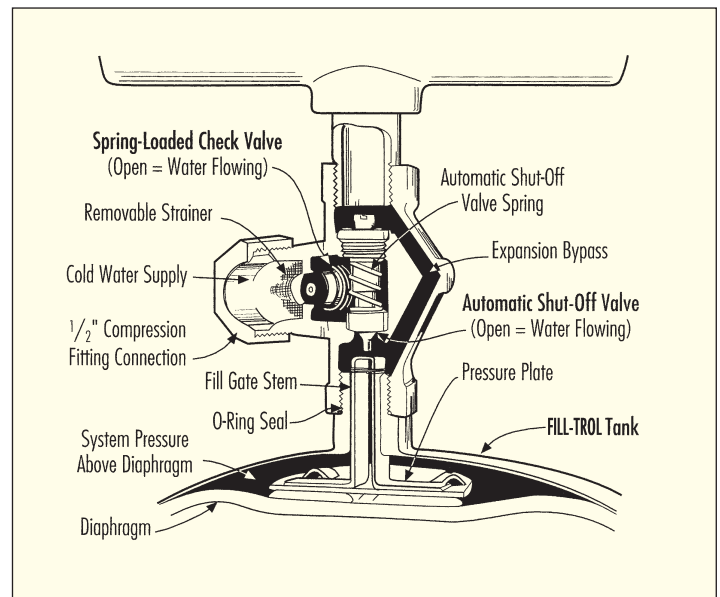

# Commercial non-ASME Models



## The SX Series EXTROL®

- Factory pre-charged to 12 psig
- Maximum working pressure: 100 psig
- Maximum operating temperature: 240°F

Model Number	Tank Volume (Gallons)	Max. Accept Volume (Gallons)	A Height (Inches)	B Diameter (Inches)	System Conn' (Inches)	Shipping Weight (lbs.)
SX-30V	14	11.3	24 3/4	15 3/8	1	25
SX-40V	20	11.3	32 1/2	15 3/8	1	33
SX-60V	32	11.3	47 1/2	15 3/8	1	43
SX-90V	44	34.0	36	22	1 1/4	69
SX-110V	62	34.0	46 3/4	22	1 1/4	92
SX-160V	86	46.0	47 1/4	26	1 1/4	123

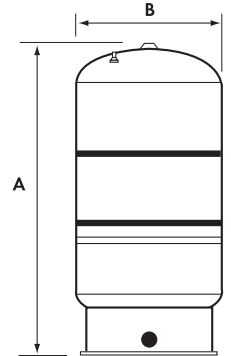

<sup>1</sup> System Connection is NPTF

## SX Series Sizing & Selection Data

BOILER	TYPE OF RADIATION AND PIPING SYSTEM			
	Net Output in 1000's of BTU	Finned Tube Baseboard or Radiant Panels with Series Loop System	Convectors or Unit Heaters with One Pipe System	Radiators or One Pipe System
MBH	Use Model	Use Model	Use Model	Use Model
200	SX-30V	SX-30V	SX-30V	SX-30V
250	SX-30V	SX-30V	SX-30V	SX-40V
300	SX-30V	SX-30V	SX-40V	SX-40V
350	SX-30V	SX-30V	SX-40V	SX-60V
400	SX-30V	SX-40V	SX-60V	SX-60V
450	SX-40V	SX-40V	SX-90V	SX-90V
500	SX-40V	SX-40V	SX-60V	SX-90V
550	SX-40V	SX-60V	SX-60V	SX-90V
600	SX-40V	SX-60V	SX-90V	SX-90V
650	SX-60V	SX-60V	SX-90V	SX-90V
700	SX-60V	SX-60V	SX-90V	SX-90V

BOILER	TYPE OF RADIATION AND PIPING SYSTEM			
	Net Output in 1000's of BTU	Finned Tube Baseboard or Radiant Panels with Series Loop System	Convectors or Unit Heaters with One Pipe System	Radiators or One Pipe System
MBH	Use Model	Use Model	Use Model	Use Model
750	SX-60V	SX-60V	SX-90V	SX-110V
800	SX-60V	SX-90V	SX-90V	SX-110V
850	SX-60V	SX-90V	SX-90V	SX-110V
900	SX-60V	SX-90V	SX-110V	SX-110V
950	SX-90V	SX-90V	SX-110V	SX-110V
1000	SX-90V	SX-90V	SX-110V	SX-110V
1100	SX-90V	SX-90V	SX-110V	SX-160V
1200	SX-90V	SX-90V	SX-110V	SX-160V
1300	SX-90V	SX-110V	SX-160V	SX-160V
1400	SX-110V	SX-110V	SX-160V	SX-160V
1500	SX-110V	SX-110V	SX-160V	(2)SX-110V

*These recommendations are calculated on average boiler water volumes and the average water volumes of currently popular types of radiation and piping systems. The industry operating standards of 12 psig fill pressure and 30 psig relief pressure are used. For boiler sizes or operating conditions other than above, refer to page 8, or consult our technical department for recommendations.*

## Typical Installation of Commercial Models

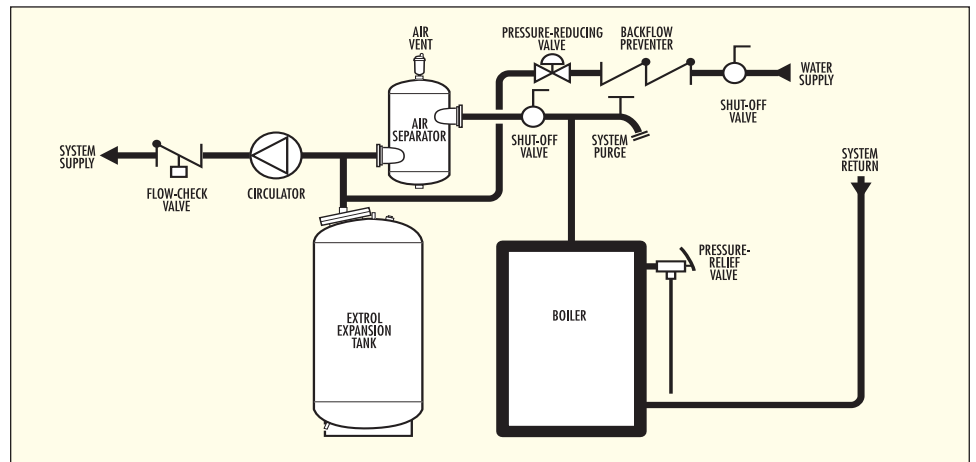



# Commercial ASME Models



## AX Series EXTROL® Horizontal & Vertical Models

- Proven diaphragm design since 1954
- Designed and constructed per ASME Section VIII, Division 1 standards
- Horizontal models are available with optional saddles
- Factory pre-charged to 12 psig
- Maximum working pressure is 125 psig
- Maximum operating temperature is 240°F

### AX Series Specifications

Model Number	Tank Volume (Gallons)	Max. Accept. (Gallons)	A – Vert. Height (Inches)	C – Horiz. Length (Inches)	B Diameter (Inches)	System Conn. <sup>1</sup> (Inches)	Horiz. Ship. Wt. lbs. (w/o saddles)	Ship Wt. lbs. (w/saddles)	Vertical Ship. Wt. (lbs.)
AX-15(V)*	8	2.4	19 ½	19 ¼	12	½	37	41	43
AX-20(V)	10.9	2.4	26 ½	26 ¼	12	½	46	50	45
AX-40(V)	21.7	11.3	29 ½	29	16 ¼	½	82	96	90
AX-60(V)	33.6	11.3	45 ½	43	16 ¼	½	103	116	110
AX-80(V)	44.5	22.6	27 ¾	27 ¼	24	1	104	127	146
AX-100(V)	55.7	22.6	32 ¾	31 ¾	24	1	114	137	167
AX-120(V)	68.0	34.0	43 ¾	39 ¾	24	1	210	235	224
AX-144(V)	77.0	34.0	48 ¾	44 ¾	24	1	240	246	244
AX-180(V)	90.0	34.0	56 ½	52 ½	24	1	242	248	266
AX-200(V)	110.0	34.0	62 ¾	62 ¾	24	1	275	306	296
AX-240(V)	132.0	46.0	53 ½	49 ¾	30	1	398	428	427
AX-260(V)	158.0	56.0	60 ½	58	30	1 ¼	449	480	476
AX-280(V)	211.0	84.0	78 ¼	75 ¾	30	1 ¼	630	660	645

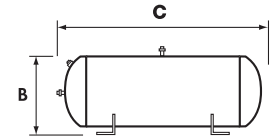

AX Horizontal Series

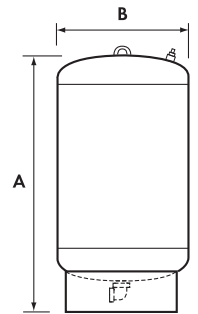

AX Vertical Series

<sup>1</sup>System Connection for models AX-15 through AX-100 (vertical and horizontal) and models AX-120V through AX-240V are NPTF, models AX-260 through AX-280 (vertical and horizontal) and AX-120 through AX-240 are NPTM.

\* To specify vertical models AX -15V – AX-280V, include V after the model number; other options available on horizontal models: • BullsEye Sight Glass • Seismic Anchor Brackets



## L Series EXTROL®

- Replaceable bladder design
- Designed and constructed per ASME Section VIII, Division 1 standards
- Free-standing on integral floor stands
- Easily installed
- Factory pre-charged to 12 psig
- Maximum working pressure is 125 psig
- Available with optional 175 or 250 psig for high-pressure applications
- Maximum operating temperature is 240°F

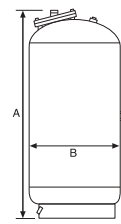

L Series

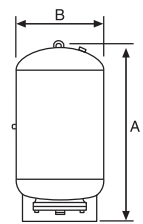

LBC Series

### L-Series Specifications

Model Number	Tank Volume (Gallons)	A Height (Inches)	B Diameter (Inches)	C Standard (Diameter)	System Conn. <sup>1</sup> (Inches)	Shipping Weight (lbs.)
200-L	53	36 ¾	24	19	1	192
300-L	80	50 ¾	24	19	1	268
400-L	106	64 ¾	24	19	1	309
500-L	132	78	24	19	1	328
600-L	158	63 ¾	30	24	1 ½	510
800-L	211	81 ¾	30	24	1 ½	565
1000-L	264	73	36	30	1 ½	691
1200-L	317	85 ¾	36	30	1 ½	779
1400-L	370	97 ¾	36	30	1 ½	905
1600-L	422	69 ¾	48	42	1 ½	1,183
2000-L	528	84	48	42	1 ½	1,264
2500-L	660	100 ¾	48	42	2	1,445
3000-L	792	118 ¾	48	42	2	1,630
3500-L	925	111	54	42	2	2,110
4000-L	1057	124 ½	54	42	2	2,230

<sup>1</sup>System Connection is NPTF

### LBC-Series Specifications

Model Number	Tank Volume (Gallons)	Accept. Volume (Gallons)	A Height (Inches)	B Diameter (Inches)	System Conn. <sup>1</sup> (Inches)	Shipping Weight (lbs.)
35-LBC	10	10	38 ¾	10	1	65
50-LBC	13	11	38 ¾	12	1	72
85-LBC	22	11	37 ¾	16	1	88
100-LBC	26	11	42 ½	16	1	94
130-LBC	34	27	37 ¾	20	1	130
165-LBC	44	27	42 ½	20	1	140
200-LBC	53	27	40 ¾	24	1	192
300-LBC	80	27	56	24	1	230
400-LBC	106	53	68 ¾	24	1	274
500-LBC	132	53	82 ½	24	1	308
600-LBC	158	53	67	30	1	442

<sup>1</sup>System Connection is NPTF

# Precise Sizing

## Precise Sizing of EXTROL® & RADIANT EXTROL™

### Things you must know:

1. Total System Volume .....(1)\_\_\_\_ gallons
2. Minimum System Temperature .....(2)\_\_\_\_ °F
3. Maximum System Temperature .....(3)\_\_\_\_ °F
4. Minimum Operating Pressure at Expansion Tank .....(4)\_\_\_\_ psig
5. Maximum Operating Pressure at Expansion Tank .....(5)\_\_\_\_ psig

### Selection of Expansion Tank:

6. Find and enter "Net Expansion Factor" .....(6)\_\_\_\_ (see table 1)
7. Amount of Expanded Water = line (1) x line (6) .....(7)\_\_\_\_ gallon
8. Find and enter "Acceptance Factor" .....(8)\_\_\_\_ (see table 2)
9. Minimum Total Tank Volume = line (7) ÷ line (8) .....(9)\_\_\_\_ gallons
10. Using Specifications on pages 6 and 7, select an Expansion Tank that is at least equal to line (9) for "Total Volume" and line (7) for Max. Expanded Water Acceptance Gallons. Multiple tanks may be required.

Table 1. Net Expansion of Water

Max.Sys. Temp. °F	Minimum System Temperature °F						
	40°F	50°F	60°F	70°F	80°F	90°F	100°F
60°F	.0005	.0049	—	—	—	—	—
70°F	.00149	.00143	.00094	—	—	—	—
80°F	.00260	.00254	.00204	.00111	—	—	—
90°F	.00405	.00399	.00350	.00256	.00145	—	—
100°F	.00575	.00569	.00520	.00426	.00315	.00170	—
110°F	.00771	.00765	.00716	.00622	.00511	.00366	.00196
120°F	.0100	.0099	.0095	.0086	.0074	.0060	.0043
130°F	.0124	.0123	.0118	.0109	.0098	.0083	.0066
140°F	.0150	.0149	.0145	.0135	.0124	.0110	.0093
150°F	.0179	.0178	.0173	.0164	.0153	.0133	.0121
160°F	.0209	.0208	.0204	.0194	.0181	.0165	.0148
170°F	.0242	.0241	.0236	.0227	.0216	.0201	.0184
180°F	.0276	.0275	.0271	.0261	.0250	.0236	.0219
190°F	.0313	.0312	.0307	.0298	.0287	.0272	.0255
200°F	.0351	.0350	.0346	.0336	.0325	.0311	.0294
210°F	.0391	.0390	.0386	.0376	.0365	.0351	.0334
220°F	.0434	.0433	.0428	.0419	.0408	.0393	.0376
230°F	.0476	.0475	.0471	.0461	.0450	.0436	.0419
240°F	.0522	.0521	.0517	.0507	.0496	.0482	.0465

Note: For ethylene glycol and for propylene glycol contact AMTROL technical services.

Table 2. Acceptance Factors\*

Max. Oper. Pressure at Tank (psig)	Minimum Operating Pressure at Tank (psig)										
	5	10	12	15	20	30	40	50	60	70	80
27	0.527	0.408	0.360	0.288	0.168	—	—	—	—	—	—
30	0.560	0.447	0.403	0.336	0.224	—	—	—	—	—	—
35	0.604	0.503	0.463	0.403	0.302	0.101	—	—	—	—	—
40	0.640	0.548	0.512	0.457	0.366	0.183	—	—	—	—	—
45	0.670	0.586	0.553	0.503	0.419	0.251	0.084	—	—	—	—
50	0.696	0.618	0.587	0.541	0.464	0.309	0.155	—	—	—	—
55	0.717	0.646	0.617	0.574	0.502	0.359	0.215	0.072	—	—	—
60	0.736	0.669	0.643	0.602	0.536	0.402	0.268	0.134	—	—	—
65	0.753	0.690	0.665	0.627	0.565	0.439	0.314	0.188	0.062	—	—
70	0.767	0.708	0.685	0.649	0.590	0.472	0.354	0.236	0.118	—	—
75	0.780	0.725	0.702	0.669	0.613	0.502	0.390	0.279	0.167	0.056	—
80	0.792	0.739	0.718	0.686	0.634	0.528	0.422	0.317	0.211	0.106	—
90	0.812	0.764	0.745	0.716	0.669	0.573	0.478	0.382	0.287	0.191	0.096
100	0.828	0.785	0.767	0.741	0.698	0.610	0.523	0.436	0.347	0.261	0.174
110	0.842	0.802	0.786	0.762	0.723	0.642	0.561	0.481	0.401	0.321	0.241

\* Acceptance factors based on expansion tank being charged to minimum operating pressure while empty of liquid.



www.amtrol.com

Corporate Headquarters  
 1400 Division Road, West Warwick, RI USA 02893  
 Telephone: 401-884-6300 • Fax: 401-884-5276  
 AMTROL Canada, Ltd.  
 275 Shoemaker Street, Kitchener, Ontario N2E 3B3  
 Telephone: 519-478-1138 • Fax: 519-748-4231



The AMTROL® logo EXTROL® Therm-X-Trol® and Fill-Trol® are registered trademarks of AMTROL Inc. In the interest of continuous development, AMTROL Inc. and its subsidiaries reserve the right to alter designs and specifications without prior notice.

Part # 9003-031 Rev. B MC# 2680 (9/05)

©2005 AMTROL Inc.  
 Printed in USA